

**SCHEMATIC**  
**HEATHKIT EDUCATIONAL ELECTRONIC**  
**ANALOG COMPUTER**  
**MODEL EC-1**

OPERATIONAL AMPLIFIER #1

OPERATIONAL AMPLIFIER #9

AMPLIFIERS 2<sup>ND</sup> THROUGH 8<sup>TH</sup>  
V10 THROUGH V16

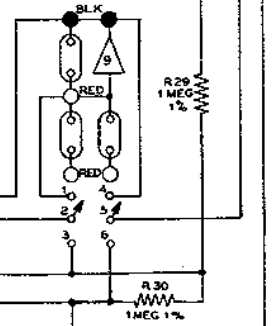
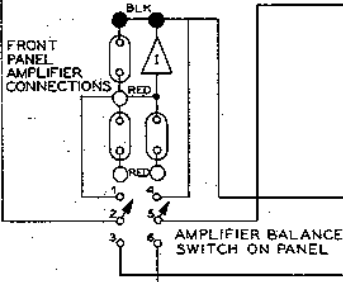
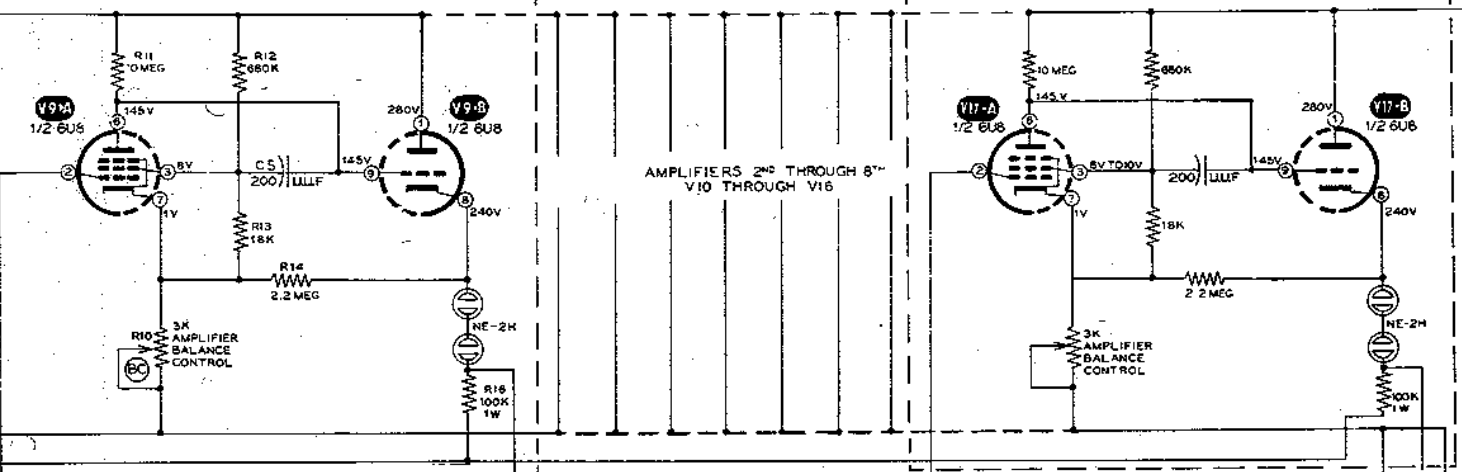

REPETITIVE OSCILLATOR

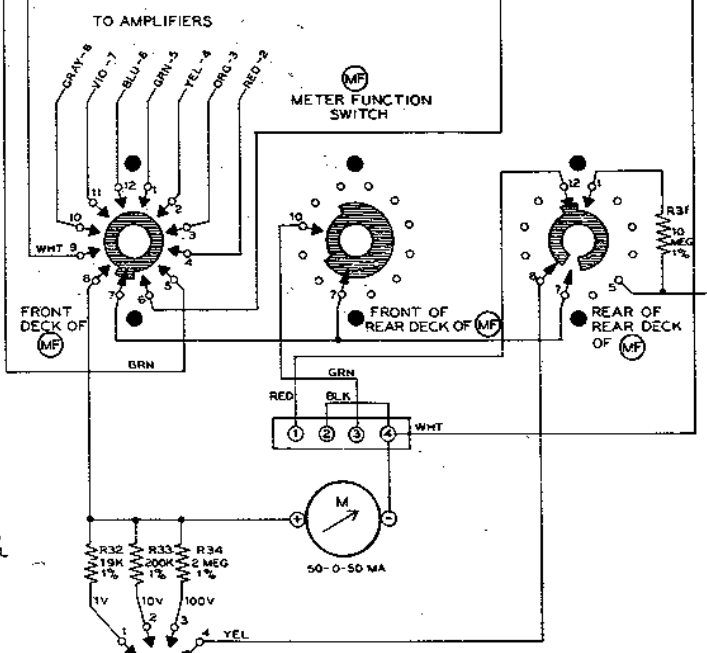
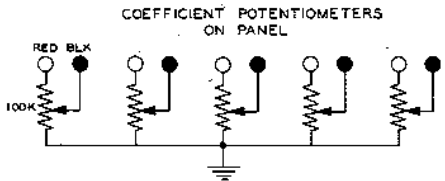
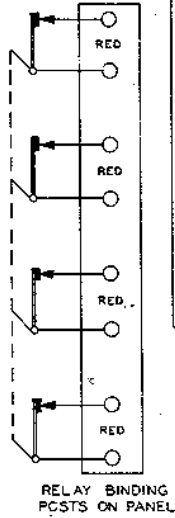
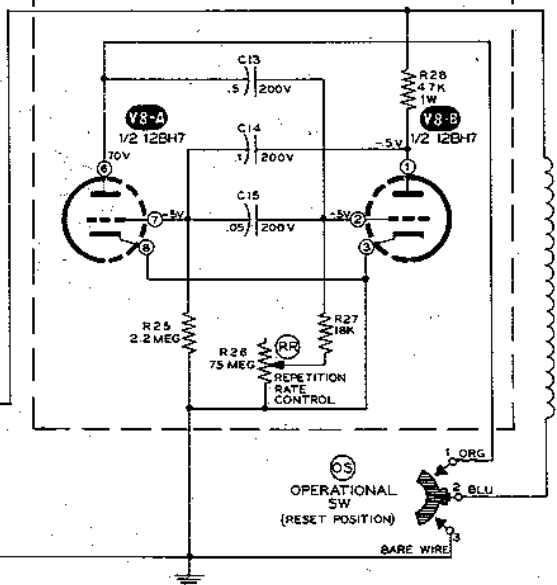

ALL SWITCHES VIEWED FROM THE REAR.

ALL RESISTANCE IN OHMS, WITH 1000 = K AND 1,000,000 = M.

ALL RESISTORS 1/2 WATT UNLESS OTHERWISE SPECIFIED.

ALL CAPACITANCE IN MICROFARADS UNLESS OTHERWISE SPECIFIED.

ALL VOLTAGES MEASURED WITH RESPECT TO CHASSIS GROUND EXCEPT INITIAL CONDITION POWER SUPPLIES WHICH ARE MEASURED WITH RESPECT TO THE NEGATIVE OF THE POWER SUPPLY.

NO FEEDBACK RESISTORS USED ON AMPLIFIER

**SCHEMATIC  
HEATHKIT EDUCATIONAL ELECTRONIC  
ANALOG COMPUTER  
MODEL EC-1**