

ALL BAND-CHANGE SWITCH SECTIONS GANGED AS ONE CONTROL.

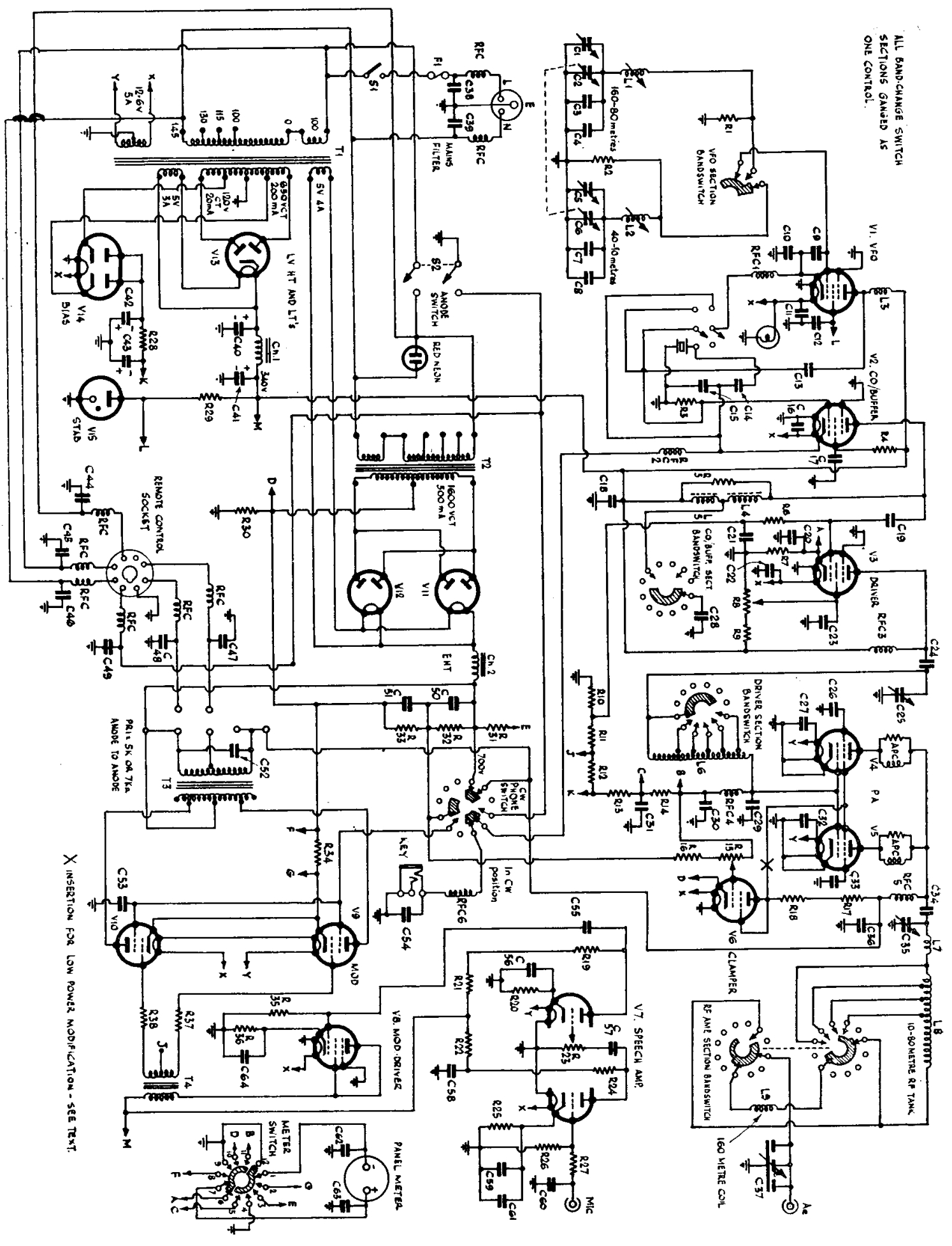

X INSERTION FOR LOW POWER MODIFICATION - SEE TEXT.

Table of Values

Circuit of the DX-100U CW/AM Phone Transmitter

C1, C5 = 20 $\mu\mu\text{F}$	C26, C28, C33 = .001 μF	R9 = 6,500 ohms	Ch2 = 6 Hy 500 mA	V4, V5 = 6146 (QVO6/20)
C2 = 35 $\mu\mu\text{F}$	C34, C36 = .001 μF , 2 KV	R11 = 470 ohms	L1 = 114.5 μH	V6 = 6A05
C3, C7, C19, C29 = 47 $\mu\mu\text{F}$	C35 = 300 $\mu\mu\text{F}$	R14 = 5.55 ohms	L2 = 9.3 μH	V7 = 12AX7
C4 = 10 $\mu\mu\text{F}$	C37 = 500 + 500 + 500 $\mu\mu\text{F}$	R15, R23 = $\frac{1}{2}$ -megohm potentiometer	L3 = 28.0 μH	V9, V10 = KT88
C6 = 11 $\mu\mu\text{F}$	C40, C41 = 40 μF , elect.	R16, R24, R26, R35 = 470,000 ohms	L4 = 6.5 μH	V11, V12 = 5R4GY
C8 = 4.7 $\mu\mu\text{F}$	C42, C43 = 20 μF , elect.	R17, R18 = 10,000 ohms	L5 = 15 μH	V13 = 5U4G
C9, C10, C55, C57 = 510 $\mu\mu\text{F}$	C50, C51 = 125 μF , elect.	R20, R25, R27 = 4,700 ohms	L6 = 10-160m. driver	V14 = 6AL5
C11, C12, C16, C17, C18, C20, C21, C22, C23, C27, C30, C31, C32, C38, C39, C44, C45, C46, C47, C48, C49, C54, C61, C62, C63, C66 = 100 $\mu\mu\text{F}$	C52 = .02 μF , 2 KV	R28, R37, R38 = 1,000 ohms	L7, L8 = 10-80m. PA tank	V15 = OAA2
C13 = 100 $\mu\mu\text{F}$	C53, C58 = 0.1 μF wkng.	R29 = 15,000 ohms, 5w.	L9 = 160m. PA coil	
C14 = 22 $\mu\mu\text{F}$	C56, C59 = 2 μF	R30, R34 = 0.1 ohm	S1 = SPST toggle	
C15 = 150 $\mu\mu\text{F}$	C60 = 220 $\mu\mu\text{F}$	R31 = 1 megohm	S2 = DPDT toggle	
C24 = 68 $\mu\mu\text{F}$	R1 = 22,000 ohms	R32, R33 = 15,000 ohms	APC = Anti-parasitic chokes on resistor forms, 4t. on 47 ohms	
C25 = 75 $\mu\mu\text{F}$	R2, R10, R12, R13 = 2,200 ohms	R36 = 680 ohms	T1 = 650-120-0v./200 mA	
	R3, R19, R22 = 100,000 ohms	RFC = Filter chokes	T2 = 800-0v./500 mA	
	R4, R5, R21 = 47,000 ohms	RFC1, RFC2, RFC3, RFC4 = 1.1 mH choke	T3 = Mod xformer, 2,800-ohm sec./5,000-ohm pri., A-A.	
	R6 = 27,000 ohms	RFC5 = 2.5 mH choke	T4 = Driver xformer, 2:1.	
	R7 = 1,02 ohms	RFC6 = 1 mH 500 mA choke	V1 = 6AU6 (EF84)	
	R8 = 25,000-ohm potentiometer	Ch1 = 7 Hy 200 mA	V2, V8 = 6CH6	
			V3 = 5763	

Fig. 2. Circuit complete of the DX-100U, for which all values are given here. Input up to 150 watts is easily obtainable on any HF band, with ample modulation capability.



V1-6AU6

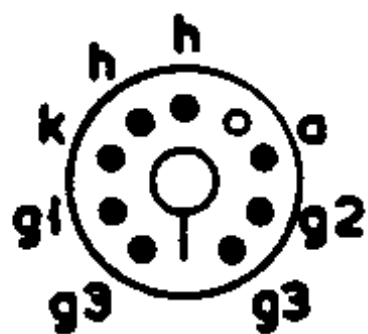

V2:V8-6CH6

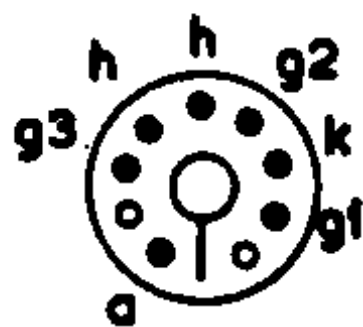

V3-5763

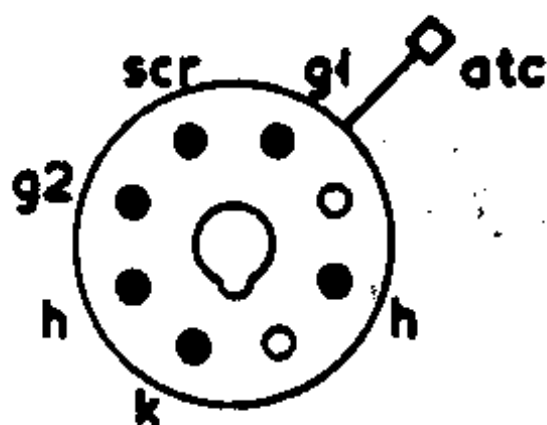

V4:V5-6146



V6-6AQ5

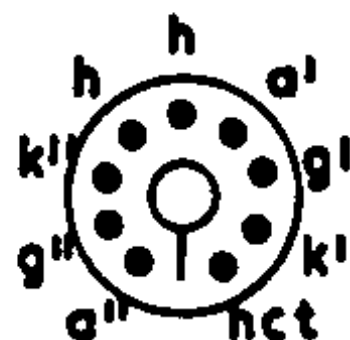

V7-12AT7

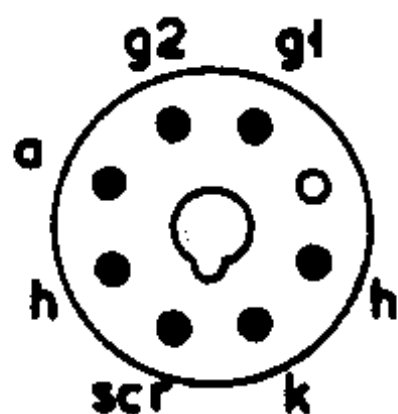

V9:V10-KT88

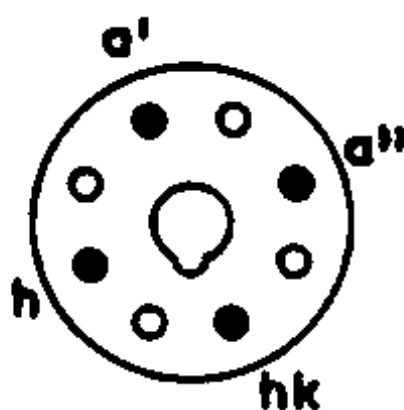

V11:V12-5R4GY

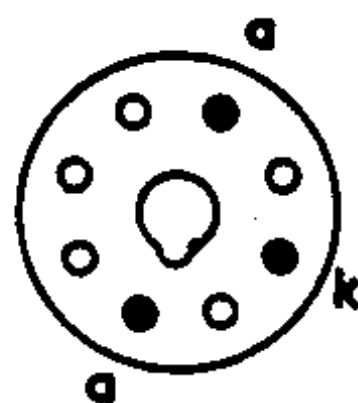

V15-OA2



V14-6AL5