

Heathkit® Manual

for the

AC POWER SUPPLY

Model HP-23C

595-2022-01

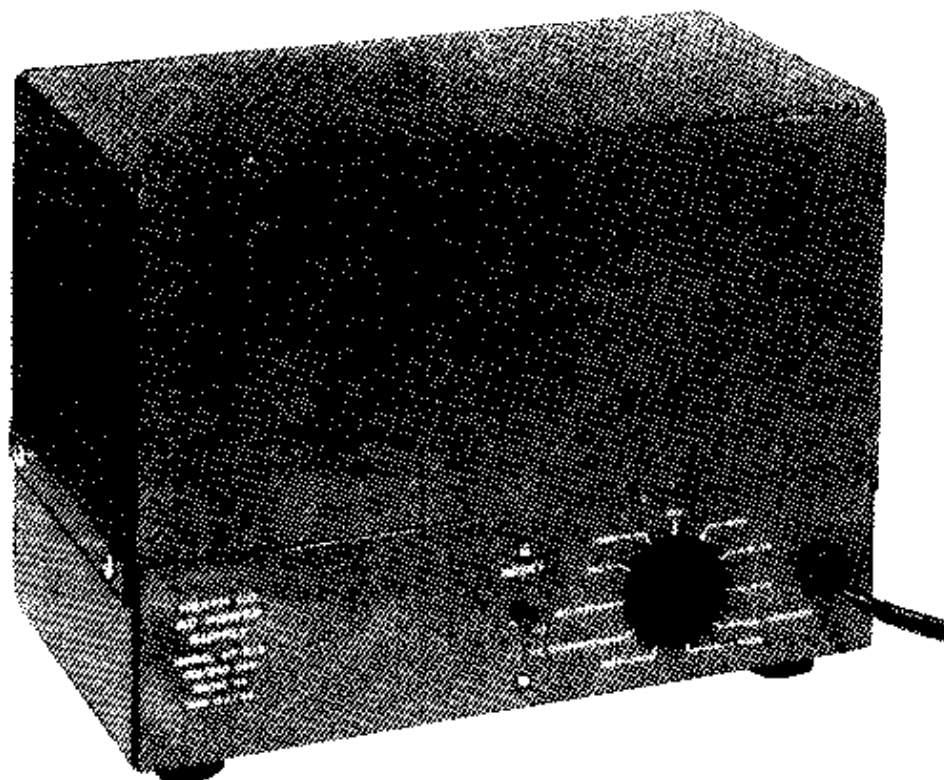

HEATH COMPANY
BENTON HARBOR, MICHIGAN 49022

Copyright © 1977
Heath Company
All Rights Reserved
Printed in the United States of America



TABLE OF CONTENTS

Introduction	2	Operation	17
Parts List	3	In Case of Difficulty	18
		Troubleshooting Chart	19
Step-by-Step Assembly		Specifications	20
Chassis Parts Mounting	4	Circuit Description	21
Transformer Wiring	8	Chassis Photographs	22
Alternate Line Voltage Wiring	8	Schematic	Illustration Booklet, Page 4
Chassis Wiring	9	Warranty	Inside front cover
Final Wiring	12	Customer Service	Inside rear cover
Power Cable Preparation	14		
Initial Tests	15		
Final Assembly	16		

INTRODUCTION

The Heathkit Model HP-23C AC Power Supply is designed to provide all the necessary operating voltages for fixed station operation of Heathkit amateur radio transceivers. The versatility and many features of this Power Supply also make it ideal for use with many other types of amateur radio equipment.

The Power Supply features a high voltage source, a choice of two low voltage sources, a fixed bias source, and a 12.6 volt filament source. Extensive filtering and good regulation is provided for the DC sources. The power transformer has a dual primary winding which can be connected for operation from either 120 or 240 VAC power lines.

A series connection is provided at the power output socket to permit turning the Power Supply on or off remotely from the equipment with which it is used. A circuit breaker in the primary circuit provides overload and short circuit protection.

All output voltage connections from the Power Supply are made through the power output socket on the chassis. This provides an easy means of rapidly changing the equipment from mobile to fixed station operation.

Read the "Kit Builder's Guide" for information on resistors, capacitors, tools, wiring, and soldering.



PARTS LIST

Check each part against the following list. The key numbers correspond to the numbers on the Parts Pictorial (Illustration Booklet, Page 1).

To order a replacement part, always include the Part Number and use the Parts Order Form furnished with

this kit. If a Parts Order Form is not available, use one of the "Expedited Parts Order Forms" at the rear of this Manual, or refer to "Replacement Parts" inside the rear cover. Your Warranty is inside the front cover. For pricing information, refer to the separate "Heath Parts Price List."

KEY No.	HEATH Part No.	QTY.	DESCRIPTION	CIRCUIT Comp. No.
---------	----------------	------	-------------	-------------------

RESISTORS

A1	1-46-1	1	27 k Ω (red-violet-orange), 1-watt	
A2	1-15-2	1	1000 Ω (brown-black-red), 2-watt	
A2	1-24-2	5	100 k Ω (brown-black-yellow), 2-watt	

CAPACITORS

B1	25-20	2	40 μ F, 150 volt electrolytic	
B2	25-36	1	40 μ F, 450 volt electrolytic	
B3	25-265	4	125 μ F, 500 volt electrolytic	

HARDWARE

#6 Hardware

C1	250-8	8	#6 \times 3/8" sheet metal screw	
C2	250-89	9	6-32 \times 3/8" screw	
C3	252-3	9	6-32 nut	
C4	254-1	10	#6 lockwasher	
C5	259-1	1	#6 solder lug	

#8 Hardware

C6	250-137	6	8-32 \times 3/8" screw	
C7	252-4	10	8-32 nut	
C8	254-2	10	#8 lockwasher	
C9	259-2	2	#8 solder lug	

KEY No.	HEATH Part No.	QTY.	DESCRIPTION	CIRCUIT Comp. No.
---------	----------------	------	-------------	-------------------

MISCELLANEOUS

D1	57-27	7	1N2071 diode	
D2	431-1	1	2-lug terminal strip	
D3	431-11	1	5-lug terminal strip	
D4	431-86	1	6-lug terminal strip	
D5	481-1	2	Metal capacitor mounting wafer	
D5	481-3	2	Phenolic capacitor mounting wafer	
D6	438-28	1	11-pin plug	
D7	440-1	1	Plug cap	
D8	434-118	1	11-lug socket	
D9	435-1	1	Socket mounting ring	
D10	65-17	1	Circuit breaker (2.92 ampere)	
D11	73-4	1	5/16" grommet	
D12	75-71	1	Strain relief	
T1	54-807	1	Power transformer	
D13	46-56	1	Filter choke	
D14	200-1311-1	1	Chassis	
D15	205-1662-1	1	Bottom plate	
D16	100-538-2	1	Cabinet shell	
D17	261-6	4	Rubber foot	
	347-52	6'	8-wire cable	
	346-7	9'	Large sleeving	
	89-23	1	Line cord	
	390-926	1	Caution label	
	391-34	1	Blue and white label	
D18	490-5	1	Nut starter	
	597-260	1	Parts Order Form	
	597-308	1	Kit Builders Guide	
		1	Manual (See Page 1 for part number.)	
			Solder	

POWER CABLE PREPARATION

() Refer to Detail 7E and prepare one end of the 8-wire cable.

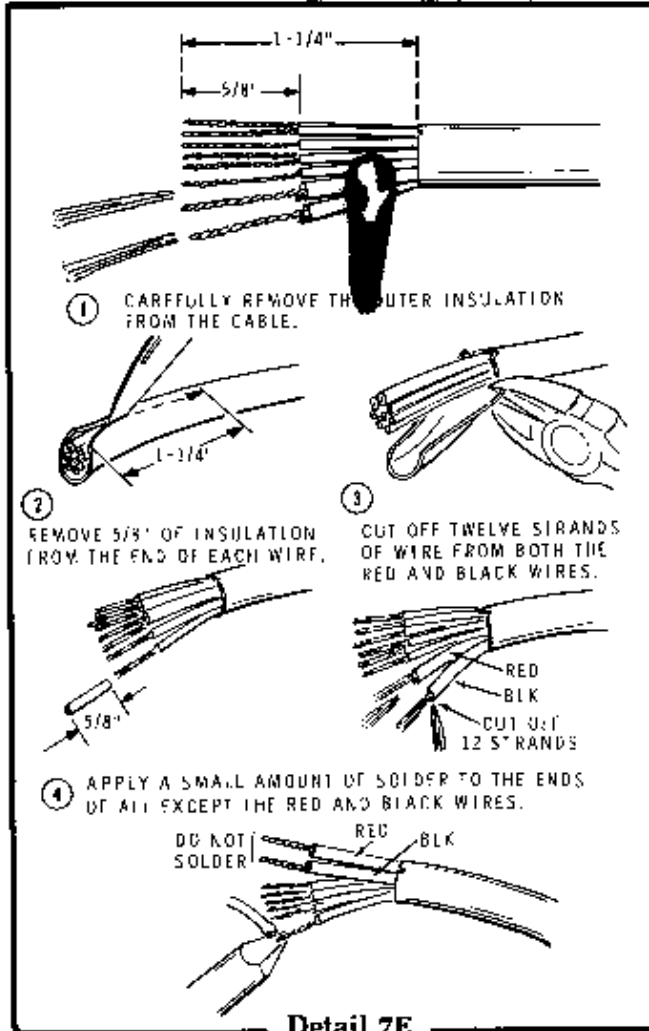

Detail 7E

() Refer to Detail 7F and connect the prepared end of the 8-wire cable to the 11-pin plug as shown.

- () Black wire to pin 2 (S-1).
- () Red wire to pin 6 (S-1).
- () Green wire to pin 1 (S-1).

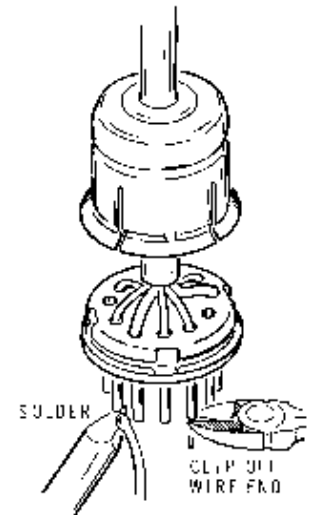
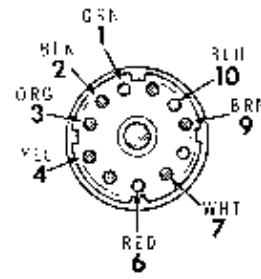

Detail 7F

- () Orange wire to pin 3 (S-1).
- () Yellow wire to pin 4 (S-1).
- () White wire to pin 7 (S-1).

NOTE: If this Power Supply is to be used with equipment that does not have provisions for switching the AC power on and off, disregard the following two steps and install a jumper wire between pins 9 (S-1) and 10 (S-1) of the 11-pin plug. To make sure that the brown and blue cable wires are NOT connected to these pins, cut and tape the ends of each wire.

- () Brown wire to pin 9 (S-1).
- () Blue wire to pin 10 (S-1).
- () Slide the plug cap over the free end of the 8-wire cable and push it onto the 11-pin plug.

This completes the wiring of your Heathkit Power Supply. Carefully inspect all connections for loose wires or unsoldered connections. Remove any wire clippings or solder splashes. Then proceed to the "Initial Tests" section.





INITIAL TESTS

To avoid possible damage, it is important that you use an ohmmeter to make the following resistance checks before you connect or turn on the Power Supply. If you cannot obtain the proper ohmmeter indication in the following steps, refer to the "In Case of Difficulty" section. DO NOT plug in the Power Supply until the difficulty has been corrected.

NOTE: Use a vacuum tube voltmeter (VTVM) or a volt-ohmmeter (VOM) to make the resistance checks in the following steps (solid-state ohmmeters do not furnish a voltage high enough to make the diodes conduct in the circuit being tested). Make sure you have the ohmmeter set correctly, since the range setting influences the meter reading when a diode is in the circuit.

- () Set the ohmmeter to the $R \times 1$ range.

Because some of the circuits to be measured contain diodes, you will obtain different resistance readings if the polarity of the meter leads is reversed in the following measurements. Therefore, in the next two steps you will determine the polarity of the ohmmeter test leads and connect the proper lead to chassis ground.

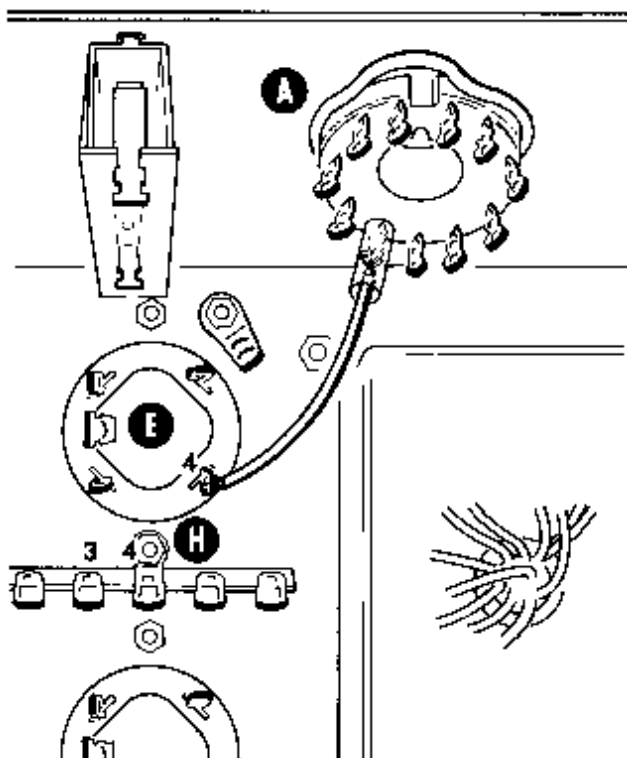

PICTORIAL 8

Refer to Pictorial 8 for the following steps.

- () Connect the negative meter lead to lug 3 and the positive meter lead to lug 4 of terminal strip H. If the resistance is approximately 10 ohms, connect the negative meter lead to lug 4 (ground) of capacitor E for the following resistance checks and disregard the next step.
- () If the meter needle remains on or near the infinity mark (full scale), reverse the meter leads. If you now obtain a reading of approximately 10 ohms, connect the positive meter lead to lug 4 (ground) of capacitor E for the following resistance checks.
- () Set your ohmmeter to the $R \times 10$ k range.

Now use the remaining meter lead to verify the resistance measurements in following steps. Some of the readings will take a few seconds to reach the indicated resistance because of the slow charging rate of the capacitors in the Power Supply.

SOCKET LUG	READING
() 1	22 k Ω or higher*
() 2	Infinity
() 3	75 k Ω or higher
() 4	75 k Ω or higher
() 5	Infinity
() 6	Infinity
() 7	0 Ω
() 8	Infinity
() 9	Infinity
() 10	Infinity
() 11	Infinity

* If you do not obtain the correct reading, interchange the meter leads for this test.

- () Disconnect the ohmmeter leads.

This completes the "Initial Tests." Proceed to "Final Assembly."

NOTE: DO NOT plug in the Power Supply until the proper connector for your equipment has been installed, as outlined in the "Operation" section of this Manual.



IN CASE OF DIFFICULTY

This section of the Manual is divided into two parts. The first part, titled "General Troubleshooting Information" described what to do about any difficulties that may occur right after the Power Supply is assembled.

The second part, a "Troubleshooting Chart," is provided to assist in servicing if the "General Information" does not clear up the problem, or if difficulties occur after the Power Supply has been in operation for some time. This Chart lists some difficulties which could arise, and several possible causes.

GENERAL TROUBLESHOOTING INFORMATION

1. Recheck the wiring. Trace each lead in colored pencil on the Pictorial as it is checked. It is frequently helpful to have a friend check your work. Someone who is not familiar with the unit may notice something consistently overlooked by the builder.
2. About 90% of the kits that are returned to Heath Company for repair do not function properly due to poor connections and soldering. Therefore, many troubles can be eliminated by rechecking all connections to make sure that they are soldered as described in the soldering section of the "Kit Builders Guide."

3. Check the values of the parts. Be sure that the proper part has been wired into the circuit, as shown in the Pictorial diagrams and as called out in the wiring instructions.

4. Check for bits of solder, wire ends or other foreign matter which may be lodged in the wiring.

5. If, after careful checks the trouble is still not located, check voltage readings against those on the Schematic. NOTE: All voltage readings were taken with an 11 megohm input voltmeter. Voltages shown are with no load on the output.

6. A review of the "Circuit Description," and a study of the Schematic Diagram will help you locate a difficulty in the Power Supply.

7. Check for loose hardware. Be especially careful that metal capacitor mounting wafers and terminal strip mounting feet are well grounded.

NOTE: In an extreme case where you are unable to resolve a difficulty, refer to the "Customer Service" information inside the rear cover of this Manual. Your Warranty is located inside the front cover.



Troubleshooting Chart

DIFFICULTY	POSSIBLE CAUSE
Completely inoperative.	<ol style="list-style-type: none"> 1. Circuit breaker open. 2. Pin 9 or 10 on power output socket or cable plug open or incorrectly wired. 3. Remote switching circuit in associated equipment faulty. 4. Power transformer T1.
Circuit breaker opens when reset.	<ol style="list-style-type: none"> 1. Short in power transformer windings. 2. Short in rectifier or filter circuits. 3. Short in associated equipment. 4. Overload in associated equipment.
No high B+ voltage.	<ol style="list-style-type: none"> 1. Diodes D1, D2, D3 or D4 faulty. 2. Pin 4 on power output socket or power cable plug open or incorrectly wired. 3. Power transformer T1.
No low B+ voltage.	<ol style="list-style-type: none"> 1. Diode D5 and/or D6. 2. Filter choke L1. 3. Pin 3 of power output socket or cable plug open or incorrectly wired. 4. Polarity of diodes or filter capacitors is incorrect.
No bias voltage.	<ol style="list-style-type: none"> 1. Diode D7. 2. Resistor R7 or R8. 3. Pin 1 of power output socket or cable plug open or incorrectly wired.
High B+ voltage only half of indicated value with no load, less under load.	<ol style="list-style-type: none"> 1. Diode D1, D2, D3 or D4. 2. Capacitor C1 or C2.
Low B+ voltage only half of indicated value.	<ol style="list-style-type: none"> 1. Diode D5 or D6.
All voltages only half of indicated values.	<ol style="list-style-type: none"> 1. Power transformer primary wired for 240 VAC when Power Supply is used on 120 VAC.

SPECIFICATIONS

HIGH VOLTAGE SUPPLY

Output Voltage	820 volts DC, no load. 700 volts DC at 250 mA.
Effective Output Capacitance	62.5 μ F.
Ripple	Less than 1% at 250 mA.
Duty Cycle	Continuous up to 150 mA. 50% at 300 mA.

LOW VOLTAGE SUPPLY (high tap)

Output Voltage	350 volts DC no load. 300 volts DC at 150 mA (with 100 mA load on High Voltage)
Ripple	Less than .05% at 150 mA.
Duty Cycle	Continuous up to 175 mA.

LOW VOLTAGE SUPPLY (low tap)

Output Voltage	275 volts DC, no load. 250 volts DC, at 100 mA (with 100 mA load on High Voltage).
Ripple	Less than .05% at 150 mA.
Duty Cycle	Continuous up to 175 mA.

OTHER OUTPUT VOLTAGES

Fixed Bias	-130 volts DC, no load. -100 volts DC, at 20 mA.
Filament	12.6 volts AC at 5.5 amperes.

GENERAL

Power Requirements	120/240 volts AC, 50/60 Hz, 350 watts.
Dimensions	9" long \times 4-3/4" wide \times 6-3/4" high.
Net Weight	16 lbs.

The Heath Company reserves the right to discontinue products and to change specifications at any time without incurring any obligation to incorporate new features in products previously sold.

CIRCUIT DESCRIPTION

To better understand the circuit operation, refer to the Schematic Diagram while you read the following description. Each section of the Power Supply will be discussed individually.

PRIMARY CIRCUIT

The circuit breaker, transformer primary, and two terminals of the power output socket are wired in series across the AC line. The Power Supply may be controlled by the off-on switch in the equipment being used with it. The dual primary winding may be connected in series for 240 VAC line operation, or in parallel for use on a 120 VAC line.

HIGH VOLTAGE SECONDARY CIRCUIT

The high voltage winding applies approximately 282 volts AC (rms) to a full-wave voltage doubler rectifying circuit consisting of silicon diodes D1, D2, D3, and D4, and capacitors C1 and C2. These diodes are connected so that during one-half cycle, capacitor C2 becomes charged; during the next half cycle capacitor C1 is charged. Resistors R1, R2, R3, and R4 are connected in the circuit to provide a discharge path for capacitors C1 and C2. The capacitors are charged individually, but discharge in series to produce a DC voltage equal to approximately twice the applied peak AC voltage. Excellent dynamic regulation is

provided by the large capacitance values of C1 and C2. The output of the voltage doubler circuit has a low ripple content and no further filtering is required.

LOW VOLTAGE CIRCUIT

The low voltage winding is tapped so that either 95 or 125 volts AC (rms) may be applied to a half-wave voltage-doubler rectifying circuit consisting of diodes D5 and D6, and capacitors C3 and C4. Capacitor C4 is also used with choke L1 and capacitor C5 in a pi filter; C4 is the input capacitor in the filter network. The use of a high-capacitance input pi filter network provides a well filtered DC output that has a very low percentage of ripple.

BIAS VOLTAGE CIRCUIT

The bias voltage is obtained from the low tap on the low voltage winding. About 95 volts AC (rms) is applied to half-wave rectifier diode D7. Capacitors C6 and C7, with resistor R7, provide a filter network to remove the ripple from the bias voltage. -130 volts of fixed bias is coupled to the power output socket.

FILAMENT VOLTAGE CIRCUIT

The 12.6 volt filament winding provides 12.6 VAC to the power output socket.

CHASSIS PHOTOGRAPHS

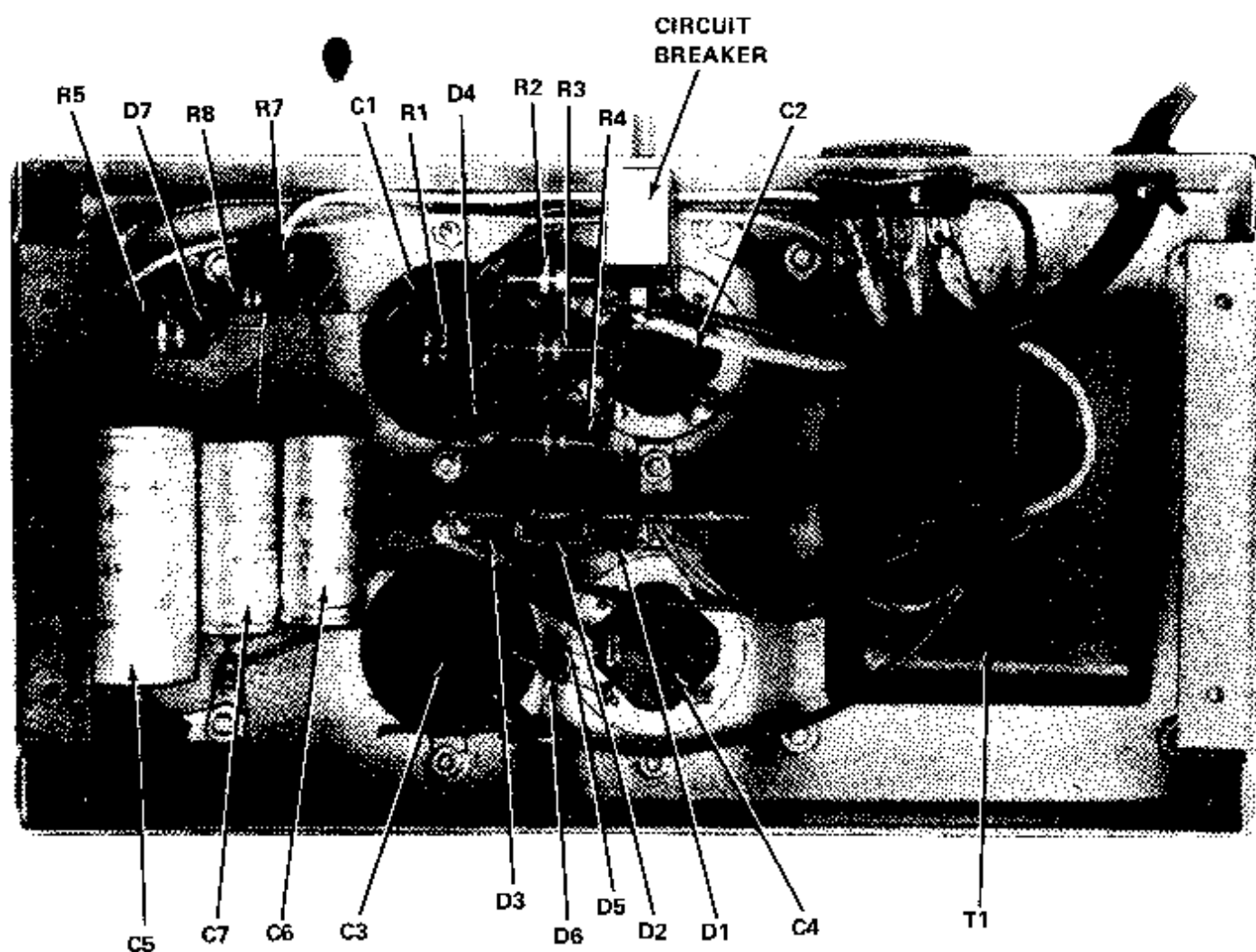

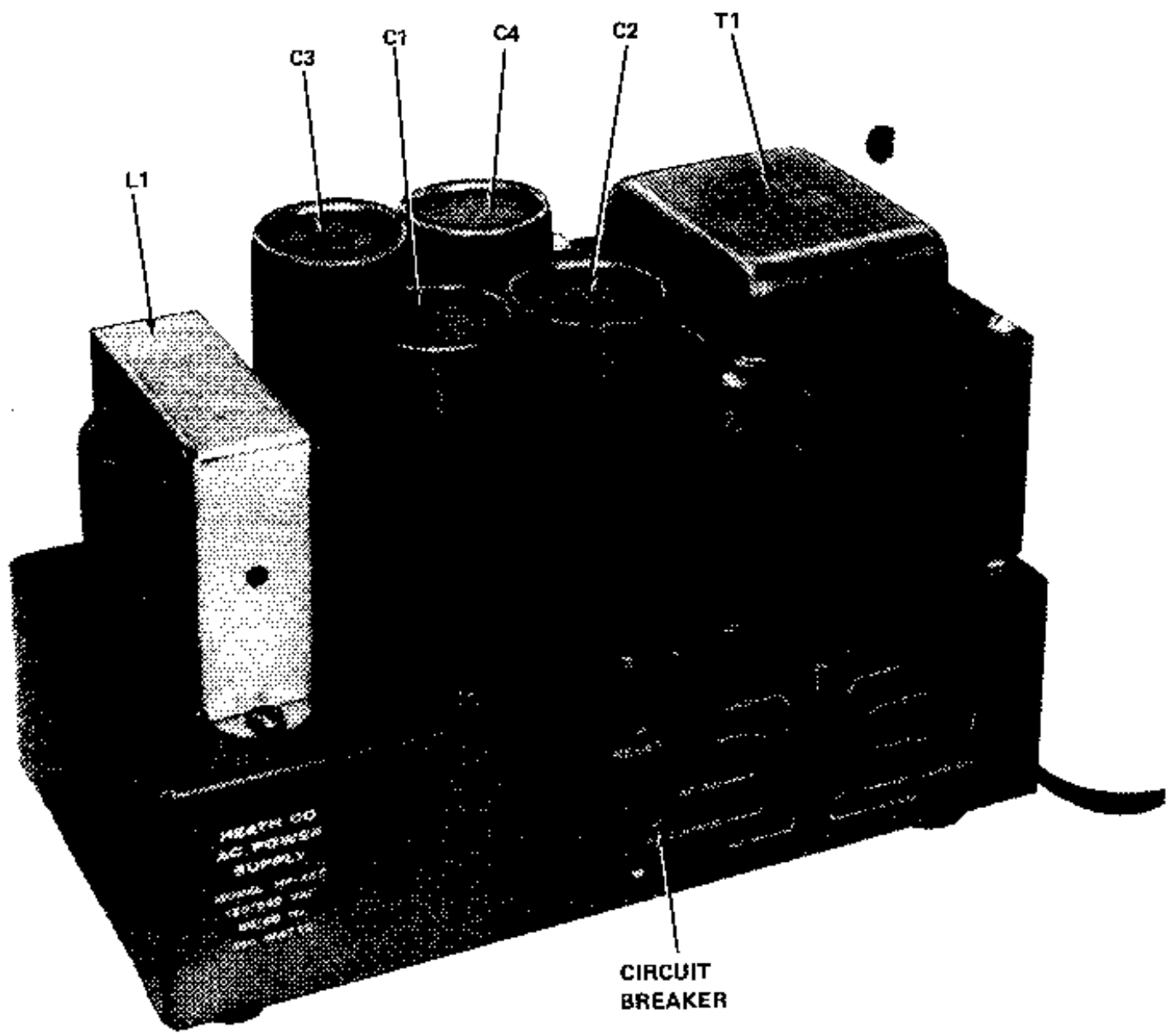

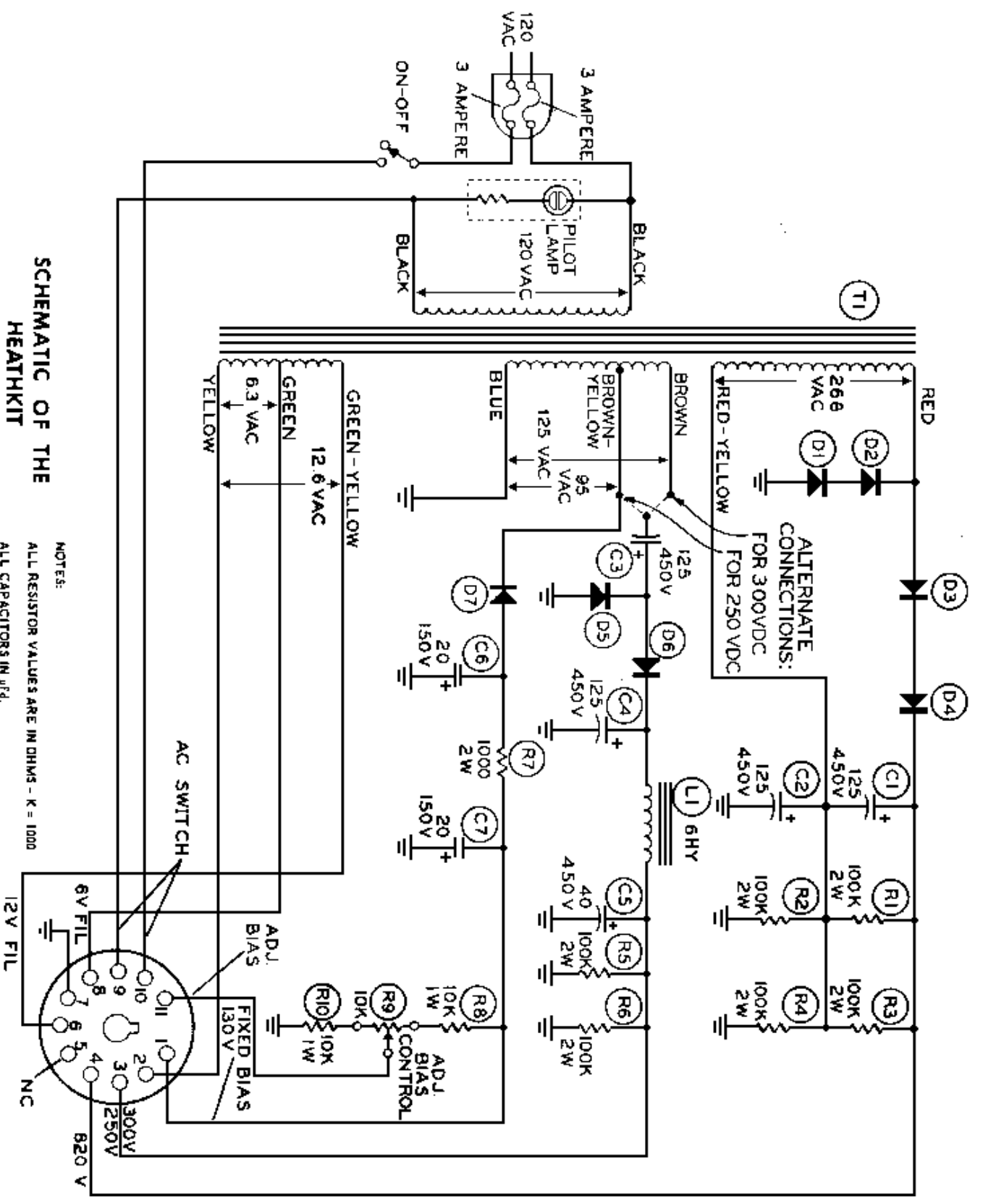

SCHEMATIC OF THE HEATHKIT

AC POWER SUPPLY

MODEL HP - 23

NOTES:

ALL RESISTOR VALUES ARE IN OHMS - K = 1000

ALL CAPACITORS IN μFD.

ALL DC VOLTAGES MEASURED FROM POINT INDICATED TO GROUND.

VOLTAGES MADE WITH 11 MEGOHM INPUT VTVM.