

PRICE \$2.00

HEATH COMPANY • DENTON HARBOR, MICHIGAN

# HEATHKIT® ASSEMBLY MANUAL



**FET/TRANSISTOR TESTER  
MODEL IT-121**

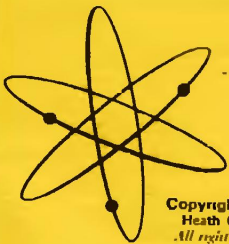

Copyright © 1972  
Heath Company  
All rights reserved

595 1427 01

Dear Customer:

The Heathkit electronic product you have purchased is one of the best performing electronic products in the world.

Here's how we aim to keep it that way:

### Your Heathkit Warranty

During your first 90 days of ownership, any parts which we find are defective, either in materials or workmanship, will be replaced or repaired free of charge. And we'll pay shipping charges to get those parts to you — anywhere in the world.

If we determine a defective part has caused your Heathkit electronic product to need other repair, through no fault of yours, we will service it free — at the factory, at any retail Heathkit Electronic Center, or through any of our authorized overseas distributors.

This protection is exclusively yours as the original purchaser. Naturally, it doesn't cover damage by use of acid-core solder, incorrect assembly, misuse, fire, flood or acts of God. But, it does insure the performance of your Heathkit electronic product anywhere in the world — for most any other reason.

### After-Warranty Service

What happens after warranty? We won't let you down. If your Heathkit electronic product needs repairs or you need a part, just write or call the factory, your nearest retail Heathkit Electronic Center, or any Heath authorized overseas distributor. We maintain an inventory of replacement parts for each Heathkit model at most locations — even for many models that no longer appear in our current product line-up. Repair service and technical consultation are available through all locations.

We hope you'll never need our repair or replacement services, but it's nice to know you're protected anyway — and that cheerful help is nearby.

Sincerely,

HEATH COMPANY  
Benton Harbor, Michigan 49022

# Assembly and Operation of the



## FET/TRANSISTOR TESTER

MODEL IT-121

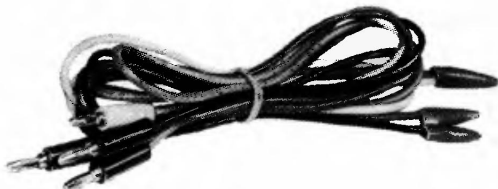
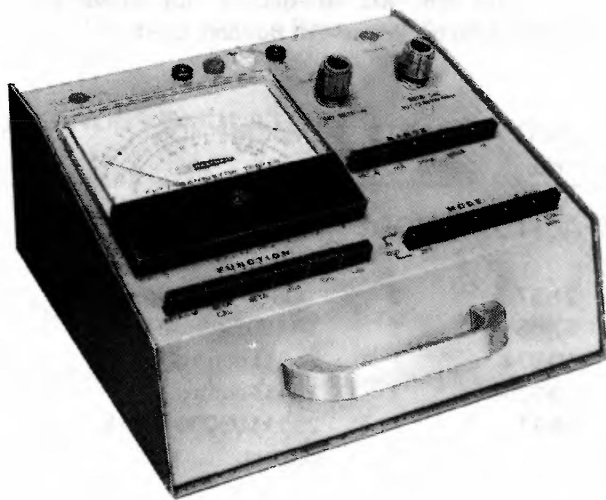

### TABLE OF CONTENTS

Introduction . . . . .	2
Parts List . . . . .	2
Assembly Notes . . . . .	4
Step-by-Step Assembly . . . . .	5
Subpanel Assembly and Wiring . . . . .	8
Front Panel Assembly and Wiring . . . . .	13
Subpanel Installation . . . . .	15
Final Wiring . . . . .	17
Test and Adjustment . . . . .	19
Final Assembly . . . . .	20
Operation . . . . .	20
In Case of Difficulty . . . . .	29
Troubleshooting Chart . . . . .	30
Factory Repair Service . . . . .	30
Specifications . . . . .	31
Circuit Description . . . . .	32
Chassis Photograph . . . . .	38
Circuit Board X-Ray Views . . . . .	39
Schematic. . . (fold-out from page) . . . . .	41

HEATH COMPANY  
BENTON HARBOR, MICHIGAN 49022



## INTRODUCTION

The Heathkit Model IT-121 FET/Transistor Tester is a quality instrument for quick, accurate tests of conventional (bipolar) transistors, diodes, FET's, SCR's, triacs, and unijunction transistors. Gain (DC Beta), transconductance (Gm), and leakage values are read directly on the large easy-to-read meter.

You can quickly and easily test devices either in-circuit or out-of-circuit. The Tester provides special circuitry to balance out in-circuit impedances. Use either the color coded leads for in-circuit tests or the built-in transistor and FET sockets for out-of-circuit tests.

Five current ranges permit leakage measurements as low as 1 microampere and collector currents as high as 1 ampere.

Pushbutton type range, mode, and function switches assure easy, consistent operation.

A special battery testing circuit provides a meter indication of the condition of the self-contained power supply. Another convenience of this portable instrument is the two-color front panel design, black lettering for conventional (bipolar) transistors and red lettering for FET's. Also, separate, brief operating instructions are printed on the rear panel.

*Refer to the "Kit Builders Guide" for complete information on unpacking, parts identification, tools, wiring, soldering, and step-by-step assembly procedures.*

## PARTS LIST

Check each part against the following list. The key numbers correspond to the numbers on the Parts Pictorial (fold-out from Page 5).

Any part that is packaged in an envelope with a part number on it should be placed back in its envelope after it is identified until that part is called for in a step.

To order replacement parts, use the Parts Order Form furnished with this kit. If one is not available, see "Replacement Parts" in the "Kit Builders Guide."

KEY PART No.	KEY PART No.	PARTS Per Kit	DESCRIPTION	PRICE Each
<b>RESISTORS</b>				
<b>1/2-Watt</b>				
A1	1-129	3	4.7 $\Omega$ , 10% (yellow-violet-gold)	.10
A1	1-105	1	10 k $\Omega$ , 5% (brown-black-orange)	.10
A2	2-63	1	15 $\Omega$ , 1%, precision	.20
A2	2-141	2	166 $\Omega$ , 1%, precision	.20
A2	2-197	1	360 $\Omega$ , 1%, precision	.20
A2	2-293	1	1500 $\Omega$ , 1%, precision	.20
<b>Other</b>				
A3	2-11-2	1	1.5 $\Omega$ , <u>2-watt</u> , precision	1.00
A4	3-13-3	1	.15 $\Omega$ , <u>3-watt</u> , precision	1.00

KEY PART No.	KEY PART No.	PARTS Per Kit	DESCRIPTION	PRICE Each
<b>CAPACITORS-DIODE-CONTROLS</b>				
B1	21-57	2	.005 $\mu$ F disc capacitor	.10
B2	57-65	1	1N4002 silicon diode	.20
B3	10-934	1	750 $\Omega$ control	.50
B4	10-926	1	15 k $\Omega$ control	1.60
B5	14-11	1	250 k $\Omega$ /5000 $\Omega$ (5 k) control	2.95
<b>HARDWARE</b>				
<b>#2 Hardware</b>				
C1	250-175	10	2-56 x 3/8" screw	.05
C2	252-51	10	2-56 nut	.05
C3	254-7	10	#2 lockwasher	.05
<b>#4 Hardware</b>				
C4	250-52	8	4-40 x 1/4" screw	.05
C5	252-2	8	4-40 nut	.05
C6	254-9	8	#4 lockwasher	.05

KEY PART No.	PARTS No.	DESCRIPTION	PRICE Each
<b>#6 Hardware</b>			
C7	250-155	6 #6 x 3/8" sheet metal screw	.05
C8	255-49	3 #6 spacer	.05
<b>#10 Hardware</b>			
C9	250-107	2 10-24 x 1/4" screw	.05
C10	254-3	2 #10 lockwasher	.05
<b>Control Hardware</b>			
C11	252-7	2 Control nut	.05
C12	253-10	2 Control flat washer	.05
C13	254-4	2 Control lockwasher	.05
<b>SOCKETS-JACKS-PLUGS</b>			
D1	434-116	2 Transistor socket	.55
D2	436-11	1 Red banana jack	.15
D2	436-22	1 Black banana jack	.15
D2	436-24	1 White banana jack	.15
D2	436-29	1 Green banana jack	.20
D3	438-13	4 Banana plug	.15
D4	260-53	4 Alligator clip	.10
<b>FEET-KNOBS-INSULATORS</b>			
E1	261-29	8 Rubber foot	.05
E2	462-249	2 Knob	.40
E3	70-6	1 Red banana plug insulator	.10
E3	70-5	1 Black banana plug insulator	.10
E3	70-8	1 White banana plug insulator	.10
E3	70-9	1 Green banana plug insulator	.10
E4	73-34	4 Rubber insulator	.10
<b>WIRE</b>			
	341-1	1 Black <u>stranded</u>	.10/ft
	341-2	1 Red <u>stranded</u>	.10/ft
	341-5	1 White <u>stranded</u>	.15/ft
	341-6	1 Green <u>stranded</u>	.15/ft
	344-50	1 Black	.05/ft
	344-51	1 Brown	.05/ft
	344-52	1 Red	.05/ft
	344-54	1 Yellow	.05/ft
	344-55	1 Green	.05/ft
	344-59	1 White	.05/ft

KEY PART No.	PARTS No.	DESCRIPTION	PRICE Each
<b>Wire (cont'd.)</b>			
	344-70	1 White-black	.05/ft
	344-71	1 White-brown	.05/ft
	344-72	1 White-red	.05/ft
	344-73	1 White-orange	.05/ft
	344-74	1 White-yellow	.05/ft
	344-75	1 White-green	.05/ft
	344-77	1 White-violet	.05/ft
	344-78	1 White-gray	.05/ft

**MISCELLANEOUS**

	85-1167-1	1 Circuit board	2.60
F1	203-1412-1	1 Front panel	5.60
F2	90-561-1	1 Cabinet shell	4.35
F3	204-1837	1 Subpanel	1.90
F4	207-82	5 Clamp	.10
F5	211-14	1 Handle	.60
F6	214-76	2 Battery holder	.65
F7	407-173	1 Meter	12.20
F8	455-50	2 Knob insert	.10
F9	64-97	1 Mode switch	4.80
F10	64-98	1 Range switch	4.10
F11	64-99	1 Function switch	5.00
F12	490-5	1 Nut starter	.10
	597-260	1 Parts Order Form	
	597-308	1 Kit Builders Guide	
	391-34	1 Blue and white label	
		1 Manual (See front cover for part number.)	2.00
		Solder (Additional 3' rolls of solder, #331-6, can be ordered for \$.15 each.)	

The following batteries should be purchased at this time for use in the completed Kit:

- 2 D-cell flashlight batteries (alkaline type preferred for longer life).

The above prices apply only on purchases from the Heath Company where shipment is to a U.S.A. destination. Add 10% (minimum 25 cents) to the price when ordering from a Heathkit Electronic Center to cover local sales tax, postage, and handling. Outside the U.S.A. parts and service are available from your local Heathkit source, and will reflect additional transportation, taxes, duties, and rates of exchange.

- ( ) Install a prepared knob on the SET BETA =  $\infty$  control.
- ( ) Install the remaining knob on the BETA CAL control.

This completes the wiring of your Transistor Tester. Proceed to "Test and Adjustment."

## TEST AND ADJUSTMENT

Figure 1 shows the front panel of the Transistor Tester. Study the figure carefully to identify the function of each switch, control, jack, and socket.

If any trouble is encountered in the following steps, refer to the "In Case of Difficulty" section on Page 29.

- ( ) Be sure the ON-OFF switch is in the OFF (out) position.
- ( ) The meter needle should be on the extreme left mark on the scale as shown in Figure 1. If the pointer is not over this mark, slowly turn the Mechanical Zero screw, while you lightly tap the meter face with your finger to properly position the pointer.

### BATTERY TEST

- ( ) Press the following front panel pushbutton switches:

10 mA  
BETA =  $\infty$   
BAT. TEST

- ( ) Be sure the PNP-NPN switch is in the NPN (out) position.
- ( ) Press the ON-OFF switch to the ON (in) position. The meter pointer should be within the BAT OK area on the meter. A new battery will cause the pointer to deflect off scale on the right side of the meter. This is normal.
- ( ) Press the PNP-NPN switch to the PNP (in) position. The meter pointer should be within the BAT OK area on the meter. A new battery will cause the pointer to deflect off scale on the right side of the meter.
- ( ) Release the ON-OFF switch to the OFF (out) position.

### ADJUSTMENT

- ( ) Connect the test leads to the appropriate front panel jacks.
- ( ) Connect the 166  $\Omega$ , 1%, precision resistor between the collector (black) test lead and the emitter (red) test lead.

- ( ) Press the following front panel pushbutton switches:

TRANS  
Iceo  
10 mA

- ( ) Press the PNP-NPN switch to the PNP (in) position.
- ( ) Press the ON-OFF switch to the ON (in) position.
- ( ) Adjust the control on the circuit board to position the meter pointer at the 85 mark on the leakage scale.
- ( ) Release the PNP-NPN switch to the NPN (out) position. The meter reading should not change. If the reading is different, note the position of the pointer. (If the meter indication is greater than 90, or less than 80, replace the batteries.) Then readjust the control on the circuit board to place the pointer half way between the noted point and the 85 mark.

- ( ) Remove the resistor from the test leads. Tape this resistor to the inside of the front panel for future use.

- ( ) Release the ON-OFF switch to the OFF (out) position.

- ( ) Press the following front panel pushbutton switches:

FET  
GM = 0  
100  $\mu$ A

- ( ) Press the P CHAN-N CHAN switch to the P CHAN (in) position.
- ( ) Press the ON-OFF switch to the ON (in) position.
- ( ) Rotate the SET Gm = 0 control. If the meter pointer can be positioned above and below the 0 mark (full scale) on the Gm scale, the FET circuitry is operating properly.

- ( ) Release the P CHAN-N CHAN switch to the IN CHAN (out) position and repeat the previous step.

- ( ) Release the ON-OFF switch to the OFF (out) position.

This completes the "Test and Adjustment" of your Transistor Tester. Proceed to "Final Assembly."

## FINAL ASSEMBLY

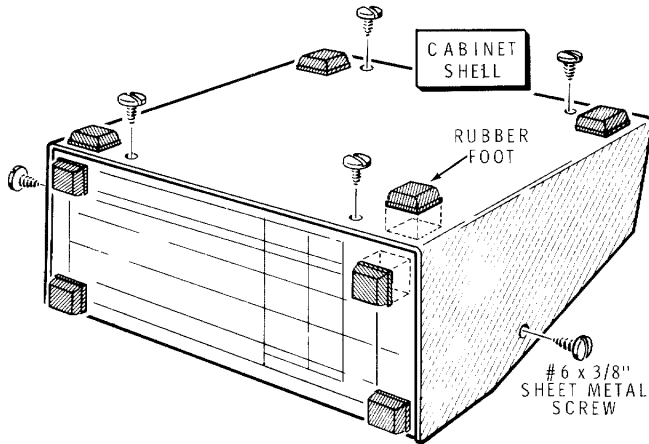

PICTORIAL 16

Refer to Pictorial 16 for the following steps.

- ( ) Install the cabinet shell on the front panel with #6 x 3/8" sheet metal screws.
- ( ) Remove the backing paper from the rubber feet and install them on the cabinet shell and the rear of the front panel as shown.

This completes the assembly of your Transistor Tester. Proceed to the "Operation" section.

## OPERATION

### GENERAL INFORMATION

The Transistor Tester measures the DC beta (gain) characteristics of transistors and the Gm (transconductance) characteristics of FET's (field effect transistors), characteristics that will even vary between transistors of the same type. These tests give you actual operating characteristics of a transistor and not merely a "bad" or "good" rating. Also, unijunction transistors, diodes, silicon controlled rectifiers, and triode AC switches can be easily tested.

Refer to Figure 1 for the locations and descriptions of the controls, switches, and connections on the Tester.

Transistors may either be plugged into the test sockets on the Transistor Tester or the test leads may be used. To use the test leads, connect the black test lead to the collector (C), the white test lead to the base (B), and the red test lead to the emitter (E) of the transistor being tested. When you test FET's (field effect transistors) or UJT's (unijunction transistors), connect the black test lead to the drain (D), the red test lead to the source (S), and the white test lead to the gate (G) of the device. If the transistor has two gates, connect the green test lead to the second gate (G).

Some transistors have a fourth lead connected to an internal shield. Leave this lead disconnected in the test procedure (bend it out of the way when you plug transistors into the transistor test socket).

**CAUTION:** Never connect the Transistor Tester, or test a device, while power is applied to the circuit. The Tester and/or the circuit could be damaged.

When devices are tested in-circuit, you may sometimes find it difficult to connect the test leads to the device because its leads are either too short or inaccessible. In such cases, you can usually connect each test lead to the lead of another component that is connected to the desired terminal on the device. To determine where you can connect the test leads on the circuit board, shine a light through the circuit board; this will let you trace each foil from the device to the other components. In cases where this is impractical, solder a short piece of wire to the printed circuit foil that is connected to the lead of the device; then connect the test lead to this wire.

The front panel lettering is in two colors, black and red. The black lettering calls out the controls used primarily when transistors are tested, while the red lettering calls out the controls relating to FET testing. Remember, when performing any of the following tests, if the TRANS switch is pressed in, refer to the black lettering; if the FET switch is pressed in, refer to the red lettering.

Proceed to the particular test procedure you wish to perform. Remember, it is a good idea to occasionally test the batteries before you use the Tester, especially if the Tester has not been used for some time.

### BATTERY TEST

Test the batteries as follows:

1. Release the NPN-PNP switch to the NPN (out) position to check one battery.

2. Press the BAT TEST switch.
3. Press the ON-OFF to the ON (in) position. The meter pointer should fall within the BAT OK mark.
4. Press the NPN-PNP switch to the PNP (in) position to check the other battery. The meter pointer should fall within the BAT OK mark.
5. Release the ON-OFF switch to the OFF (out) position.

NOTE: Do not leave the Tester in the battery test position any longer than necessary or the battery life will be shortened.

## TRANSISTOR TESTING

### General

Out-of-circuit beta (gain) tests are always quite accurate, but the accuracy of an in-circuit test depends on the shunting resistances of the circuit in which the transistor is being used. If the transistor indicates gain when tested in-circuit, you may consider the transistor to be good. Leakage tests must always be made with the transistor out of the circuit, since the resistance in the circuit could cause an erroneous reading. To make a quick good or bad test, perform only the beta test.

Before you test a transistor, it is helpful, but not necessary, to determine its class (signal, intermediate power, or power), and its type (NPN or PNP).

The current capability of a transistor is what determines its class. Both the specific application and the physical size can be used to estimate the amount of current that passes through a transistor. A schematic diagram is helpful in identifying the particular application. Transistors with small metal cases or plastic cases will usually be classed as signal devices. Medium size metal cases and transistors with small heat sinks fall in the intermediate power class. Power transistors are usually large and most generally used with large heat sinks. Figure 2 shows examples of each class.

Figure 2 shows several lead configurations for transistors. However, since there are other configurations, be sure you know the lead configuration of your transistor before you test it.

The schematic diagram can also be used to identify the transistor type (NPN or PNP). Drawings A and B of Figure 3 show the symbols for both an NPN and PNP transistor. Notice that the arrow on the emitter lead points away from the base in the NPN transistor and points toward the base in a PNP transistor. Also, an NPN transistor will have a positive collector-to-emitter voltage while the PNP transistor has a negative collector-to-emitter voltage. If you are unable to determine the transistor type, proceed with the test. Special steps are provided to identify the type.

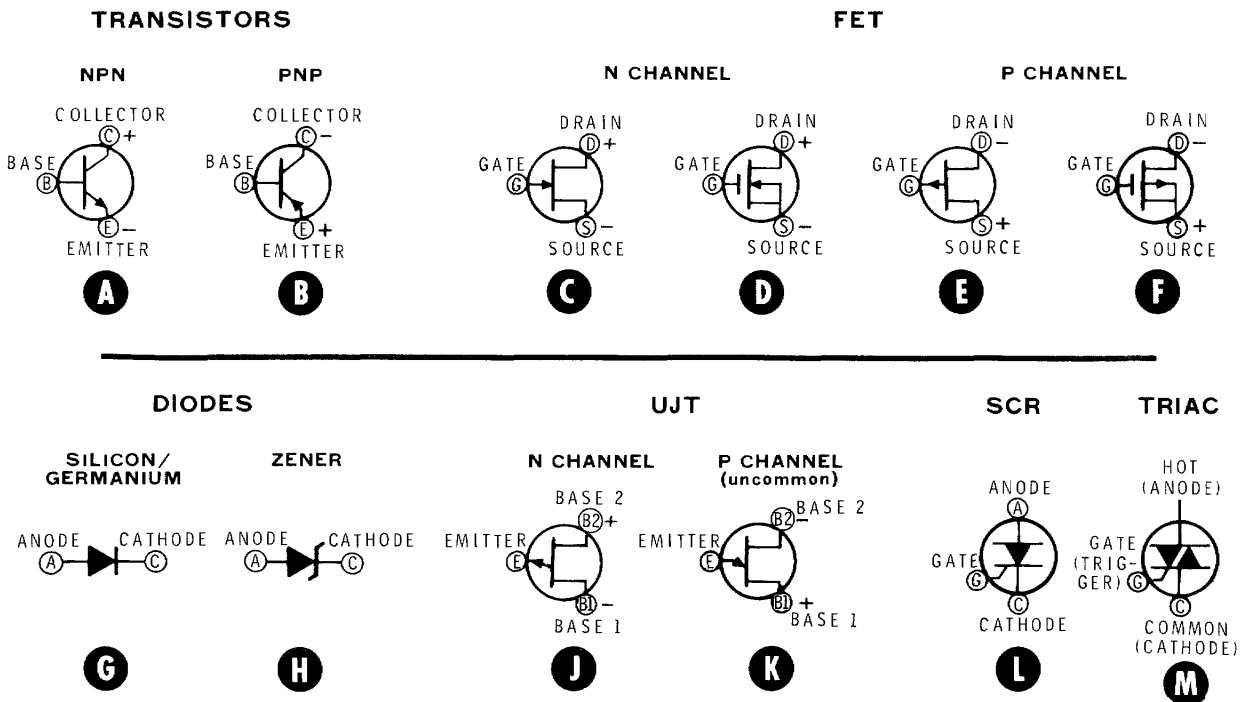
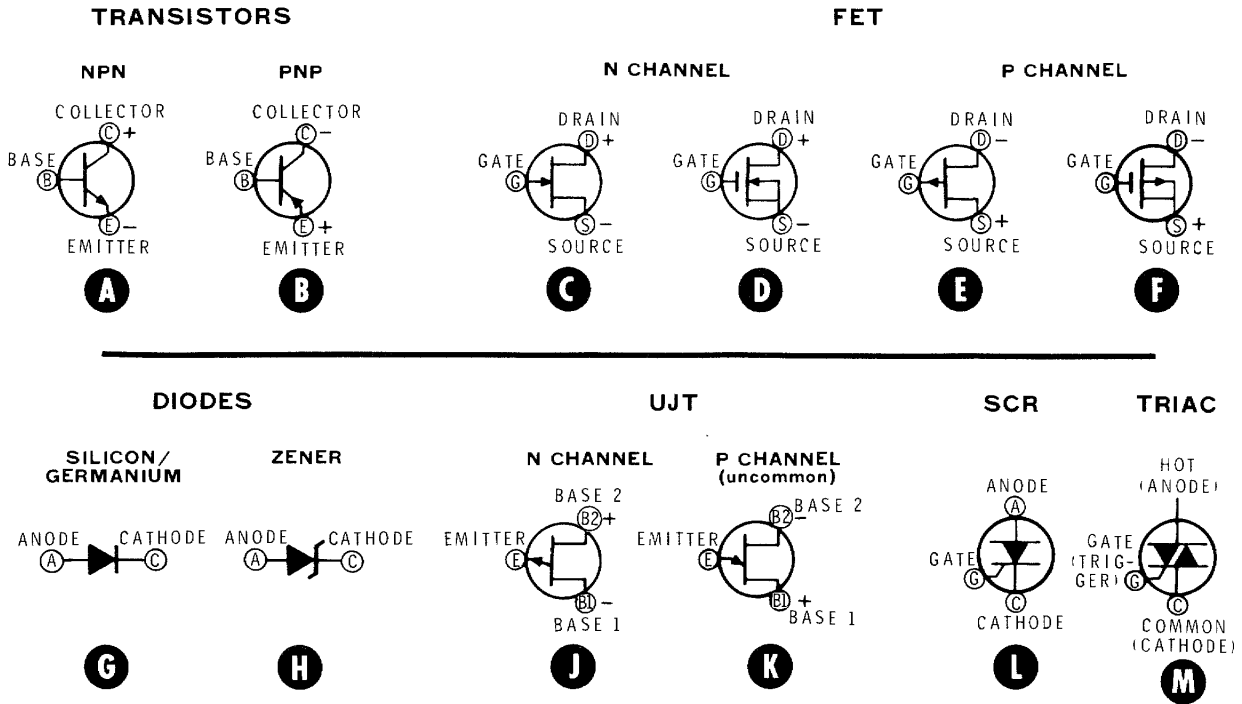

Figure 3







**Figure 3  
(Repeat)**

The following chart shows the three classes of transistors, possible applications, and the approximate operating current for each class. Use the figures in the current capability column when you select the current range for a test.

For example:

Meter indication = 3.5  
 Calibration Setting = CAL X10  
 BETA = 3.5 x 10 = 35

However, if the meter indication is greater than 50, press the next lower current range switch (in this case, 10 mA) and multiply the new meter indication by 100. Notice that this new current range provides an additional multiplication factor of 10.

EXAMPLE:

Meter indication = greater than 50  
 Select next lower current range (additional factor of 10)  
 New meter indication = 6.5  
 Calibration setting = CAL X10  
 BETA = 6.5 x 10 x 10 = 650

Keep in mind that the next lower current range can be used only when the meter indication is greater than 50 and only for the 1 A, 100 mA, and 10 mA current ranges.

CLASS	APPLICATION	CURRENT CAPABILITY
SIGNAL	AUDIO, RF, IF	1 mA – 10 mA
INTERMEDIATE POWER	AUDIO, SWITCHING	10 mA – 100 mA
POWER	AUDIO, REGULATOR, OUTPUT	100 mA – 1 A

The beta scale of the meter has three calibration points CAL X10, CAL X5, and CAL X1. The CAL X10 setting is used most often when transistors are tested out of the circuit. The chart in Figure 4 shows the relationships of the various current ranges and the calibration settings. The 100 mA current range, for instance, supplies a maximum of 100 mA collector current when the CAL X10 setting is used. In this case and as a general rule, the beta of a transistor is the meter indication multiplied by the calibration setting.

CURRENT RANGE	CALIBRATION SETTING	COLLECTOR CURRENT	BETA MULTIPLICATION FACTOR	BETA MULTIPLICATION FACTOR AFTER SWITCHING TO NEXT LOWER CURRENT RANGE
100 $\mu$ A	Not Used			
1 mA	CAL X1 CAL X5 CAL X10	.1 mA .5 mA 1 mA	X1 X5 X10	NOT AVAILABLE NOT AVAILABLE NOT AVAILABLE
10 mA	CAL X1 CAL X5 CAL X10	1 mA 5 mA 10 mA	X1 X5 X10	X10 X50 X100
100 mA	CAL X1 CAL X5 CAL X10	10 mA 50 mA 100 mA	X1 X5 X10	X10 X50 X100
1 A	CAL X1 CAL X5 CAL X10	.1 A .5 A 1 A	X1 X5 X10	X10 X50 X100

Figure 4

The following procedure pertains to both in-circuit and out-of-circuit testing. If you do not obtain the proper results when the transistor is tested in-circuit, remove it from the circuit and repeat the tests.

### Beta (Gain) Test

1. Be sure the ON-OFF switch is in the OFF (out) position.
2. Identify each lead of the transistor.
3. Connect the base (b) lead of the transistor to the B connector (white) on the Tester.
4. Connect the emitter (e) lead of the transistor to the E connector (red) on the Tester.
5. Connect the collector (c) lead of the transistor to the C connector (black) on the Tester.
6. Press the TRANS switch.
7. Press the BETA =  $\infty$  switch.
8. Determine the transistor class (signal, intermediate power or power). Then press the appropriate range switch to select the proper current.
9. Identify the transistor type (NPN or PNP). Then place the NPN-PNP switch in the appropriate position. If the type is not known, assume it to be an NPN device.
10. Press the ON-OFF switch to the ON (in) position.
11. Adjust the SET BETA =  $\infty$  control to place the meter pointer over the  $\infty$  mark on the beta scale. If you are unable to adjust the meter pointer or if it deflects off scale, the transistor may be defective or incorrectly connected to the Tester.
12. Make sure the BETA CAL control is pushed in and turned fully counterclockwise.
13. Press the BETA CAL switch.
14. Rotate the BETA CAL control and notice that the meter pointer moves accordingly. If the pointer does not move or deflects off scale, the transistor may be defective, incorrectly connected to the Tester, or the NPN-PNP switch may be in the wrong position.
15. Adjust the BETA CAL control to place the meter pointer over the desired calibration mark (CAL X10, CAL X5, or CAL X1) on the beta scale. As a rule, use the CAL X10 mark. Lower settings reduce the collector current accordingly as shown in Figure 4.

NOTE: If you cannot position the meter pointer at the desired calibration mark when testing power transistors, pull out on the BETA CAL control to extend its range. If you are still unable to calibrate the Tester at the desired mark, especially when the transistor being tested is in-circuit, use the next lower calibration mark (CAL X5 or CAL X1).

16. Press the BETA switch. Note the meter indication. Multiply this indication by the calibration setting (CAL X10, CAL X5, or CAL X1) to obtain the actual transistor beta. NOTE: If the meter indication is greater than 50, a lower current range may be selected to provide an additional multiplication factor of 10 as explained previously (only on ranges 10 mA or higher).

A transistor that is tested in-circuit and that has a beta of less than 10 should be removed from the circuit and retested. As a rule, any transistor that has a gain less than 10 when tested out-of-circuit should be considered defective.

The previous steps have explained the beta testing procedure. If the device is out of the circuit, the following leakage tests will further test the transistor. Disregard the next two steps if you are going to perform the leakage tests.

17. Release the ON-OFF switch to the OFF (out) position.
18. Disconnect the transistor from the Tester.

### Transistor Leakage Tests

Leakage tests must always be performed with the transistor out of the circuit, since the resistance of the circuit could cause erroneous readings.

Three leakage measurements (I<sub>cbo</sub>, I<sub>ces</sub>, and I<sub>ceo</sub>) will be made in the following steps.

I<sub>cbo</sub> is the measurement of the leakage current (I) between the collector (c) and the base (b) with the emitter open (o). This measurement should always be the lowest of the leakage measurements.

I<sub>ces</sub> is the measurement of the leakage current (I) between the collector (c) and the emitter (e) with the base shorted (s) to the emitter.

I<sub>ceo</sub> is the measurement of the leakage current (I) between the collector (c) and the emitter (e) with the base open (o). This measurement should always be the highest of the three leakage measurements.

In other words, for good transistors,  $I_{cbo}$  will always be less than  $I_{ces}$  and  $I_{ces}$  will always be less than  $I_{ceo}$ .

Generally, you will not obtain any measurable leakage when testing silicon transistors. Most low-power silicon transistors have very low leakage with the collector to base leakage current ( $I_{cbo}$ ) usually less than  $1 \mu A$  (one microampere). High-power silicon transistors may indicate an  $I_{ceo}$  up to  $50 \mu A$ .

Germanium transistors have an  $I_{cbo}$  that ranges from several microamperes to as high as 5 mA. The following chart is a guide to help you determine if the leakage is too high for a germanium transistor. If in doubt, refer to a transistor manual.

GERMANIUM TRANSISTOR	TYPICAL LEAKAGE CURRENT		
	$I_{cbo}$	$I_{ces}$	$I_{ceo}$
RF-IF-AUDIO	0 – 5 $\mu A$	0 – 50 $\mu A$	1 $\mu A$ – 500 $\mu A$
AUDIO-SWITCHING	0 – 10 $\mu A$	1 $\mu A$ – 100 $\mu A$	5 $\mu A$ – 1 mA
POWER	5 $\mu A$ – 100 $\mu A$	5 $\mu A$ – 1 mA	50 $\mu A$ – 5 mA

#### NOTES:

1. Be sure the "BETA TEST" has been completed before you perform the following leakage tests.
2. If the leakage current is greater than 100  $\mu A$ , causing the meter pointer to deflect off scale, select a higher current range.

3. Leakage current will increase in temperature. Even body heat from holding the transistor in your hand can increase the leakage current.

As you perform the leakage tests, analyze the result and determine if the leakages are within acceptable limits.

1. Press the  $I_{cbo}$  switch.
2. Press the 100  $\mu A$  switch. Read the leakage current directly from the leakage scale.
3. Press the  $I_{ces}$  switch. Read the leakage current directly from the leakage scale.
4. Press the  $I_{ceo}$  switch. Read the leakage current directly from the leakage scale.
5. Release the ON-OFF switch to the OFF (out) position.
6. Disconnect the transistor from the Tester.

#### FET TESTING

Drawings C and D of Figure 3 (fold-out from Page 22) show the schematic symbols for N channel FET's (field effect transistors). Notice that N channel FET's have a positive drain-to-source voltage. Drawings E and F show the schematic symbols for P channel FET's. These FET's have a negative drain-to-source voltage.

The following steps measure the  $G_m$  (transconductance) of FET's.  $G_m$  usually ranges between 500 to 10,000  $\mu mhos$ . This characteristic, like beta, can even vary between FET's of the same type. It is also useful when selecting devices (matching) that have the same characteristics.

The following procedure pertains to both in-circuit and out-of-circuit testing. If you do not obtain the proper results when the FET is tested in-circuit, remove it from the circuit and repeat the tests.

## Gm (transconductance) Test

1. Be sure the ON-OFF switch is in the OFF (out) position.
2. Identify each lead of the FET to be tested; then connect the FET to the Tester.
3. Press the FET switch.
4. Press the Gm = 0 switch.
5. Press the 100  $\mu$ A switch.
6. Identify the FET type (N channel or P channel). Then place the P CHAN - N CHAN switch in the appropriate position.
7. Press the ON-OFF switch to the ON (in) position.
8. Adjust the SET Gm = 0 control to place the meter pointer over the 0 mark on the Gm scale.
9. Press the Gm switch. Read the Gm directly from the Gm scale. Multiply this reading by 1000 to obtain Gm. If the Gm is  $\infty$  or 0, the FET is defective.
10. Press the GATE 1 switch. The Gm should decrease. If the Gm does not change or increases, first check to make sure the FET is correctly connected to the Tester and the P CHAN - N CHAN switch is in the proper position. If the Gm still does not change, or if it increases, the FET is defective.
11. If the FET being tested has two gates, press the GATE 2 switch. The Gm should decrease. If the Gm does not change, or if it increases, the FET is defective.

The previous steps have explained the Gm testing procedure. If the device is out of the circuit, the following leakage test will further test the FET. Disregard the next two steps if you are going to perform the leakage tests.

12. Release the ON-OFF switch to the OFF (out) position.
13. Disconnect the FET from the Tester.

## FET Leakage Tests

Leakage tests must always be performed with the FET out of the circuit, since the resistances of the circuit could cause erroneous readings.

Two leakage measurements ( $I_{gss}$  and  $I_{dss}$ ) will be made in the following steps.

$I_{gss}$  is the measurement of the leakage current ( $I$ ) between the gate (g) and the source (s) with the drain shorted (s) to the source. Since this leakage current is nominally in the nanoampere range, any measurable leakage indicates the FET is defective.

$I_{dss}$  is the measurement of the current ( $I$ ) between the drain (d) and the source (s) with the gate shorted (s) to the source. This measurement is not an actual leakage current, but more of a forward current between 100  $\mu$ A and 10 mA) to indicate that the FET is conducting. The  $I_{dss}$  measurement is often helpful when selecting FET's (matching) that have similar characteristics.

NOTE: Be sure the "Gm Test" has been completed before you perform the following leakage tests.

1. Press the  $I_{gss}$  switch.
2. Be sure the 100  $\mu$ A switch is pressed. Read the leakage current directly from the leakage scale. Any measurable leakage indicates that the FET is defective.
3. Press the 10 mA switch.
4. Press the  $I_{dss}$  switch. Read the current directly from the leakage scale. If necessary, select a lower current range to obtain a meter indication.
5. Release the ON-OFF switch to the OFF (out) position.
6. Disconnect the FET from the Tester.

## DIODE TESTING

NOTE: Some high voltage diodes, those that have more than a 1.5 volt drop across the junction when the diode is conducting, cannot be adequately tested.

Drawings G and H of Figure 3 show the schematic symbols for diodes.

The following diode tests measure the forward (conducting) current and the reverse (leakage) current. Like transistors, the leakage current depends on the diode type (silicon or germanium). Silicon diodes have very little leakage, while germanium diodes may have as much as several microamperes leakage current.

A good signal diode will have a forward current greater than 0.8 mA, while a good power diode (rectifier) will have a forward current greater than 0.8 A.

The actual zener voltage of a zener diode cannot be tested. However, if a zener diode tests good as a conventional diode, you can assume that it is good. Always test zener diodes and varactor diodes in the same manner as signal diodes. Some temperature compensated zener diodes cannot be tested.

The following procedure pertains to both in-circuit and out-of-circuit testing. If you do not obtain the proper results when a diode is tested in-circuit, remove it from the circuit and repeat the tests.

1. Be sure the ON-OFF switch is in the OFF (out) position.
2. Identify the diode leads.
3. Connect the cathode lead of the diode to the C connector (black) of the Tester.
4. Connect the anode lead of the diode to the E connector (red) of the Tester.
5. Press the TRANS switch.
6. Press the 100  $\mu$ A switch.
7. Press the Iceo switch.
8. Be sure the NPN-PNP switch is in the NPN (out) position.
9. Press the ON-OFF switch to the ON (in) position. Read the leakage current directly from the leakage scale. This leakage should be less than a few microamperes.
10. Press the NPN-PNP switch to the PNP (in) position.

CAUTION: In the following steps, do not select a current range that exceeds the current rating of the diode.

11. If a signal diode is being tested, press the 1 mA switch. If a power diode (rectifier) is being tested, press the 1A switch. The meter indication should be greater than 80 on the leakage scale for both types of diodes.
12. Release the ON-OFF switch to the OFF (out) position.
13. Disconnect the diode from the Tester.

## UJT TESTING

Drawings J and K of Figure 3 show the schematic symbols for both the N channel and the P channel (uncommon) UJT's (unijunction transistors).

Three measurements ( $I_{eb_2s}$ ,  $I_{b_2b_1s}$ , and  $I_{b_2es}$ ) will be made in the following steps.

$I_{eb_2s}$  is the measurement of leakage current (I) between the emitter (e) and base 2 ( $b_2$ ) with base 1 shorted (s) to base 2.

$I_{b_2b_1s}$  is the measurement of forward current (I) through base 2 ( $b_2$ ) and base 1 ( $b_1$ ) with the emitter shorted (s) to base 1. This current can be converted to  $R_{bb}$  (the resistance between base 1 and base 2) as follows:

$$\frac{1.5 \text{ V (battery voltage)}}{I_{b_2b_1s}} = R_{bb}$$

$I_{b_2es}$  is the measurement of emitter current (I) between base 2 ( $b_2$ ) and the emitter (e) with base 1 shorted (s) to the emitter.

Because only leakages are measured, unijunction transistors must be tested out-of-circuit. This will eliminate erroneous leakage indications caused by circuit resistances.

1. Be sure the ON-OFF switch is in the OFF (out) position.

2. Identify the leads of the UJT.
3. Connect the emitter (e) lead of the UJT to the G<sub>1</sub> connector (white) on the Tester.
4. Connect the base 1 (b<sub>1</sub>) lead of the UJT to the S connector (red) of the Tester.
5. Connect the base 2 (b<sub>2</sub>) lead of the UJT to the D connector (black) of the Tester.
6. Press the FET switch.
7. Press the I<sub>gss</sub> switch.
8. Press the 100 μA switch.
9. Identify the UJT type (N channel or P channel). Then place the P CHAN-N CHAN switch in the appropriate position.
10. Press the ON-OFF switch to the ON (in) position. Read the I<sub>b<sub>2</sub>s</sub> leakage current directly from the leakage scale. This leakage should be less than 1 μA.
11. Press the 1 mA switch.
12. Press the I<sub>dss</sub> switch. Read the I<sub>b<sub>2</sub>b<sub>1</sub>s</sub> current directly from the leakage scale. This current is normally between 150 μA and 400 μA. R<sub>bb</sub> (the resistance between base 1 and base 2) can be obtained by dividing 1.5 volts (battery voltage) by the current (I). For example:

$$\frac{1.5 \text{ V}}{I_{b_2 b_1 s}} = R_{bb}$$

$$I_{b_2 b_1 s} = 250 \mu\text{A} = .000250\text{A}$$

$$\frac{1.5 \text{ V}}{.00025\text{A}} = 6000 \Omega$$

$$R_{bb} = 6000 \Omega$$

13. Press the 100 mA switch.
14. If the UJT is an N channel UJT, place the N CHAN-P CHAN switch in the P CHAN (in) position. If the UJT is a P channel (uncommon) UJT, place the N CHAN-P CHAN switch in the N CHAN (out) position. Read the emitter current I<sub>b<sub>2</sub>e</sub> directly from the leakage scale. This current is nominally between 15 to 60 mA.
15. Release the ON-OFF switch to the OFF (out) position.
16. Disconnect the UJT from the Tester.

### SCR TESTING

NOTE: Some high voltage SCR's, those that have more than a 1.5 volt drop across the gate junction when the SCR is conducting, cannot be adequately tested.

Drawing L of Figure 3 shows the schematic symbol for an SCR (silicon controlled rectifier).

The following test will check the SCR to determine if it can be properly turned on and turned off.

The following procedure pertains to both in-circuit and out-of-circuit testing. If you do not obtain the proper results when an SCR is tested in-circuit, remove it from the circuit and repeat the tests.

1. Be sure the ON-OFF switch is in the OFF (out) position.
2. Identify the leads of the SCR.
3. Connect the gate (g) lead of the SCR to the B connector (white) on the Tester.
4. Connect the anode (a) lead of the SCR to the E connector (red) on the Tester.
5. Connect the cathode (c) lead of the SCR to the C connector (black) on the Tester.
6. Press the TRANS switch.





7. Place the NPN-PNP switch to the PNP (in) position.
8. Press the Iceo switch.
9. Press the 1A switch.
10. Press the ON-OFF switch to the ON (in) position.
11. Press the Ices switch; then press the Iceo switch. The SCR should now be turned on. The meter should indicate 50 or greater on the leakage scale.
12. Momentarily disconnect and then reconnect the cathode (c) lead. The SCR should now be turned off. The meter should indicate less than 5 on the leakage scale.
13. Release the ON-OFF switch to the OFF (out) position.
14. Disconnect the SCR from the Tester.
2. Identify the leads of the triac.
3. Connect the gate (g) lead of the triac to the B connector (white) on the Tester.
4. Connect the hot lead of the triac to the E connector (red) on the Tester.
5. Connect the common lead of the triac to the C connector (black) on the Tester.
6. Press the TRANS switch.
7. Place the NPN-PNP switch in the NPN (out) position.
8. Press the Iceo switch.
9. Press the 1A switch.
10. Press the ON-OFF switch to the ON (in) position.

## TRIAC TESTING

**NOTE:** Some high voltage triacs, those that have more than a 1.5 volt drop across the gate junction when the triac is conducting, cannot be adequately tested.

Drawing M Figure 3 shows the schematic symbol for a Triac (triode AC switch).

The following tests will check the triac to determine if it can be properly turned on and turned off.

The following procedure pertains to both in-circuit and out-of-circuit testing. If you do not obtain the proper results when a triac is tested in-circuit, remove it from the circuit and repeat the tests.

1. Be sure the ON-OFF switch is in the OFF (out) position.
11. Press the Ices switch; then press the Iceo switch. The triac should now be turned on. The meter should indicate greater than 50 on the leakage scale.
12. Momentarily disconnect and then reconnect the cathode (c) lead. The triac should now be turned off. The meter should indicate less than 5 on the leakage scale.
13. Press the NPN-PNP switch to the PNP (in) position. The triac should remain turned off. Now, repeat steps 11 and 12.
14. Release the ON-OFF switch to the OFF (out) position.
15. Disconnect the triac from the Tester.

## IN CASE OF DIFFICULTY

This section of the Manual is divided into two parts. The first part, titled "General Troubleshooting Information," describes what to do about the difficulties that may occur right after your Tester is assembled.

The second part, titled "Troubleshooting Chart," is provided to assist you in servicing the Tester if the "General Troubleshooting Information" fails to clear up the problem, or if difficulties occur after your Tester has been in use for some time. The "Troubleshooting Chart" lists possible difficulties that could arise along with several possible solutions to those difficulties.

Try to analyze the symptoms of any problem you might have before starting any troubleshooting procedure. This can usually be accomplished by trying the various functions of your Tester to determine abnormal operations. A review of the "Operation" section may help.

### GENERAL TROUBLESHOOTING INFORMATION

**NOTE:** The following checks will be most effective if you apply them to one part of the kit at a time.

1. Recheck the wiring. Trace each lead in colored pencil on the Pictorial as it is checked. It is frequently helpful to have a friend check your work. Someone who is not familiar with the unit may notice something you have consistently overlooked.
2. About 90% of the kits that are returned for repair do not function properly due to poor connections and soldering. Therefore, many troubles can be eliminated by a careful inspection of connections to make sure

they are soldered as described in the "Soldering" section of the "Kit Builders Guide." Reheat any doubtful connections. Be sure all wires are soldered at places where several wires are connected.

3. Check each circuit board foil to be sure there are no solder bridges between adjacent connections. Remove any solder bridges by holding a clean soldering iron tip between the two points that are bridged until the excess solder flows down onto the tip of the soldering iron.
4. Check each resistor value carefully. A resistor that is discolored, or cracked, or shows any sign of bulging would indicate that it is faulty and should be replaced.
5. Be sure the diode is installed with the banded end positioned correctly.
6. Check all component leads connected to the circuit boards. Make sure the leads do not extend through the circuit board and come in contact with other connections or parts.
7. Check all wires that are connected to the circuit board switches. Make sure the wires do not touch the other lugs. Make sure all wires are properly soldered.

**NOTE:** In an extreme case where you are unable to resolve a difficulty, refer to the "Service" section of the "Kit Builders Guide" and to the "Factory Repair Service" information on Page 30 of this Manual.

## TROUBLESHOOTING CHART

SYMPTOM	POSSIBLE CAUSE
Meter inoperative.	<ol style="list-style-type: none"> <li>1. Shorting wire across meter terminals.</li> <li>2. Batteries not installed or weak.</li> </ol>
Meter pegs left when turned on.	<ol style="list-style-type: none"> <li>1. Set Beta = <math>\infty</math> control turned fully counterclockwise.</li> <li>2. Meter leads or battery leads interchanged.</li> <li>3. One or both batteries installed backwards.</li> </ol>
Meter pegs right when Beta Cal switch is pressed in.	<ol style="list-style-type: none"> <li>1. Transistor leads incorrectly connected.</li> </ol>
No full scale deflection; Beta Cal control pulled out and turned fully clockwise.	<ol style="list-style-type: none"> <li>1. Batteries weak or have poor connection. Remove batteries, bend battery holder ends inward and replace the batteries. Rotate the batteries in the holders to insure good contact.</li> <li>2. Control R1 out of adjustment. Refer to the "Test and Adjustment" section on Page 19.</li> </ol>
Current range different than label indicates.	<ol style="list-style-type: none"> <li>1. Range switch wiring. Trace wiring from switch to circuit board.</li> <li>2. Shunt resistances. Check R1, R2, R3, and R4.</li> </ol>
Function or mode switches operate improperly.	<ol style="list-style-type: none"> <li>1. Function and mode switch jumper wires. Trace all wires associated with these switches and the circuit board.</li> </ol>

## FACTORY REPAIR SERVICE

You can return your completed kit to the Heath Company Service Department to have it repaired for a minimum service fee. (Kits that have been modified will not be accepted for repair.) Or, if you wish, you can deliver your kit to a nearby Heathkit Electronic Center. These centers are listed in your Heathkit catalog.

To be eligible for replacement parts under the terms of the warranty, equipment returned for factory repair service, or delivered to a Heathkit Electronic Center, must be accompanied by the invoice or the sales slip, or a copy of either. If you send the original invoice or sales slip, it will be returned to you.

If it is not convenient to deliver your kit to a Heathkit Electronic Center, please ship it to the factory at Benton Harbor, Michigan and observe the following shipping instructions:

Prepare a letter in duplicate, containing the following information:

- Your name and return address.
- Date of purchase.
- A brief description of the difficulty.
- The invoice or sales slip, or a copy of either.
- Your authorization to ship the repaired unit back to you C.O.D. for the service and shipping charges, plus the cost of parts not covered by the warranty.

Attach the envelope containing one copy of this letter directly to the unit before packaging, so that we do not overlook this important information. Send the second copy of the letter by separate mail to Heath Company, Attention: Service Department, Benton Harbor, Michigan 49022.

Check the equipment to see that all parts and screws are in place. Then, wrap the equipment in heavy paper. Place the equipment in a strong carton, and put at least THREE INCHES of resilient packing material (shredded paper, excelsior, etc.) on all sides, between the equipment and the carton. Seal the carton with gummed paper tape, and tie it

with a strong cord. Ship it by prepaid express, United Parcel Service, or insured parcel post to:

Heath Company  
 Service Department  
 Benton Harbor, Michigan 49022

## SPECIFICATIONS

DC Beta . . . . .	1 to 5000 with the following ranges available:  1 to 50, 5 to 250, 10 to 500, 50 to 2500, 100 to 5000.
Collector Currents Available . . . . .	1 mA, 5 mA, 10 mA, 50 mA, 100 mA, 500 mA, and 1 A.
$G_m$ . . . . .	0 to 50,000 $\mu$ mhos.
Leakage Measurements . . . . .  ( $I_{ceo}$ , $I_{ces}$ , $I_{cbo}$ , $I_{dss}$ , $I_{gss}$ )	Five current ranges, $\pm 5\%$ .  0-100 $\mu$ A, 0-1 mA, 0-10 mA, 0-100 mA, 0-1 A
Out-of-Circuit Accuracy . . . . .	$\pm 2\%$ , $\pm 2\%$ arc for DC beta and leakage.
In-Circuit Accuracy . . . . .	Indicates good or bad transistor, FET, diode, SCR, or triac.
Diode Test . . . . .	Tests for forward conduction and reverse leakage (out-of-circuit).
SCR and Triac Tests . . . . .	Tests for proper conduction and blocking.
Unijunction Transistor Test . . . . .	Measures $I_{eb_2s}$ , $I_{b_2b_1s}$ , and Emitter Current (out-of-circuit).
Power . . . . .	Two 1-1/2 volt D cells.
Dimensions (overall) . . . . .	9-9/16" wide x 8-5/8" deep x 5-1/4" high.
Net Weight (Less batteries) . . . . .	3-1/2 lbs.

---

The Heath Company reserves the right to discontinue instruments and to change specifications at any time

without incurring any obligation to incorporate new features in instruments previously sold.

## CIRCUIT DESCRIPTION

Refer to the Schematic Diagram (fold-out from Page 41) while you read this "Circuit Description."

### General Consideration

All of the following circuit explanations refer only to NPN transistors or N channel FET's. The descriptions also apply equally to PNP transistors and P channel FET's except that the polarity of the meter and both batteries (B1 and B2) must be reversed.

Diode D1 protects the meter by limiting the voltage across it to 0.6 volts. Capacitors C1 and C2 prevent oscillations from occurring in the device being tested. Resistors R5 and R6 limit the current to protect controls R11 and R12 in case a short circuit occurs. For simplicity, the above components are not shown in the following partial schematics.

All switches are shown on the Schematic in the released (out) position even though this configuration does not represent a particular test. This enables you to easily trace a particular test circuit by pressing (mentally) only the switch related to that test.

### BATTERY TEST

Each battery is tested separately. The NPN position of the NPN-PNP switch connects battery B1 into the battery

testing circuit. The PNP position of the NPN-PNP switch connects battery B2 into the battery testing circuit. A load, simulating operating conditions, is connected across each battery while the battery voltage is being measured. This assures that the battery is capable of supplying adequate current and voltage for the tests.

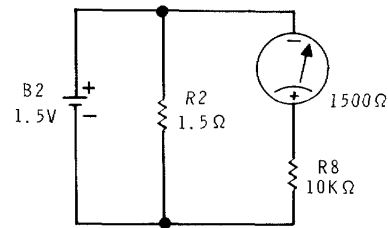

BAT TEST

Figure 5

When the Bat Test switch is pressed, resistor R2 is placed across the battery terminals to load the battery. See Figure 5. The meter, now functioning as a voltmeter, measures the battery voltage. If the battery is serviceable (0.9 volt or more), the meter pointer will fall within the Bat OK mark on the meter.

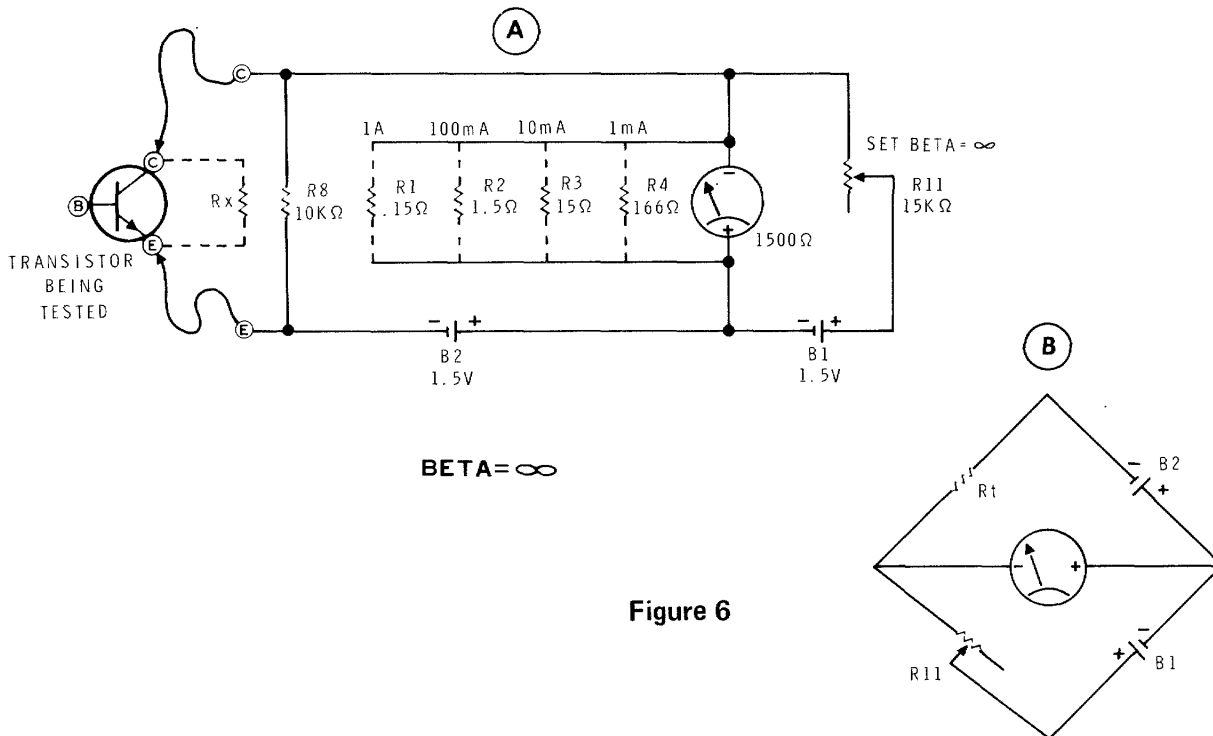

Figure 6

**BETA = ∞**

The "beta = ∞" circuit, as shown in Part A of Figure 6, primarily compensates for the transistor collector load resistance, R8, and in-circuit resistances, Rx.

This circuit is basically a bridge circuit as shown in Part B of Figure 6. Resistor Rt represents load resistor R8 plus any in-circuit resistance, Rx. Because Rx varies widely from one circuit to another, control R11 (Set Beta = ∞) provides a means of balancing the bridge circuit. A true representation of beta can now be achieved since any unbalance that occurs in subsequent tests will be directly associated with the transistor collector current.

Resistors R1 through R4 are meter shunt resistances for the 1 A through 1 mA ranges respectively. The 100 μA range does not use a meter shunt resistor.

**BETA CAL**

The base of the transistor is now connected into the circuit through control R12 (Beta Cal) and resistor R10. See Figure 7. Control R12 adjusts the base current of the transistor until sufficient collector current flows through the meter to place the pointer over the CAL X10 mark (full scale). The collector current is now equal to the particular current range you selected.

Because resistor R10 is the same value as the meter resistance, the meter and resistor R10 can be interchanged in the following tests to measure base current without changing the collector current.

Notice that a shunt resistor is in parallel with resistor R10. This total resistance (R10 and its shunt) is ten times larger than the resistance of the meter and its shunt for the same range. Thus, when the meter is placed in the base circuit, it will read 1/10 the current measured in the collector circuit.

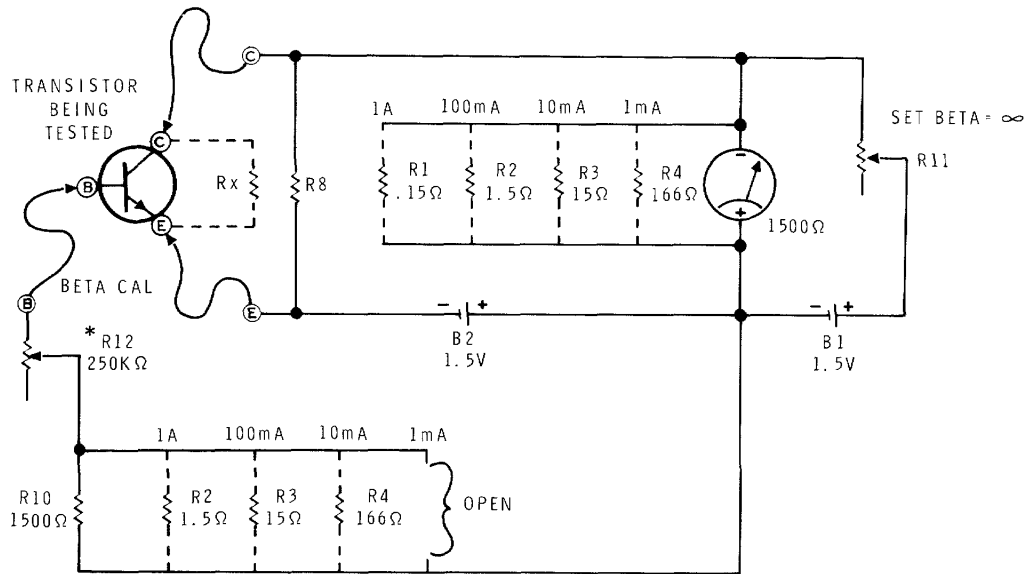

\* R13 (5000Ω)  
IF CONTROL IS PULLED  
OUT (1A RANGE ONLY).

**BETA CAL**

**Figure 7**

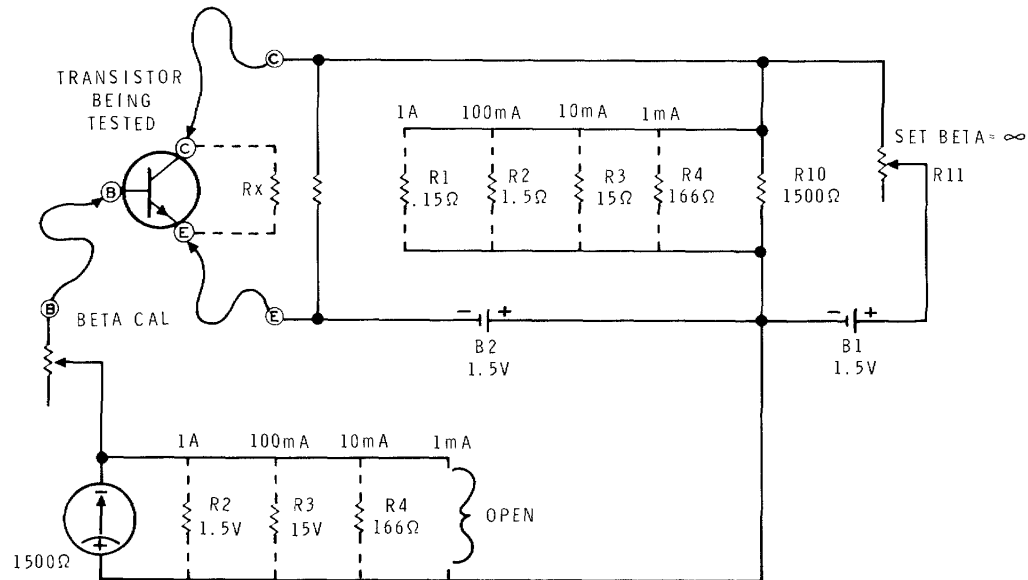

### BETA

Figure 8

### BETA

This circuit is similar to the beta cal circuit except that the meter is now in the base circuit and resistor R10 is in the collector circuit. See Figure 8. Also, because the shunt resistor that was previously across R10 is now across the meter, only 1/10 the current is required for full-scale meter deflection.

Since beta, by definition, is collector current ( $I_c$ )/base current ( $I_b$ ), these currents could be measured and the ratio computed to obtain beta. However, the meter scale takes into account the currents and their ratio, and reads directly in terms of beta.

For example, when the 10 mA current range is selected, and the Beta Cal control is adjusted to place the meter pointer over the CAL X10 mark (full scale), a collector current of 10 mA flows through the device. Now, when the meter is in the base circuit, assume that a 1 mA current flows. The meter pointer will deflect full scale (1 mA) and indicate a beta of 1 times a multiplier of 10 (CAL X10). Thus, beta = 10. The same result can be obtained from the formula:

$$\frac{I_c}{I_b} = \frac{10 \text{ mA}}{1 \text{ mA}} = 10$$

### $I_{cbo}$ , $I_{ces}$ , AND $I_{ceo}$

Leakage currents are measured by placing a battery and the meter (and its shunt resistance) in series with two of the transistor leads. The meter indicates leakage current from 0 to 1 ampere, depending on the current range selected. Since the leakage currents are quite small, usually measured in microamperes ( $\mu A$ ), the transistor must be removed from the circuit.

$I_{cbo}$  is the measurement of the current that flows between the collector and the base of the transistor with the emitter open (unconnected). See Figure 9.

$I_{ces}$  is the measurement of the current that flows between the collector and the emitter of the transistor with the base connected to the emitter. See Figure 10.

$I_{ceo}$  is the measurement of the current that flows between the collector and the emitter of the transistor with the base open (unconnected). See Figure 11.

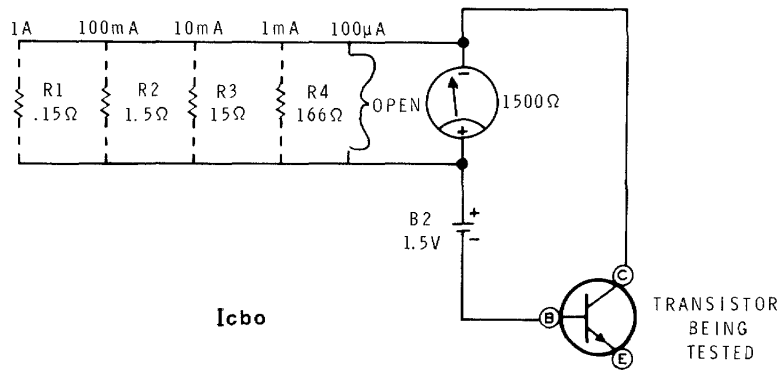

Figure 9

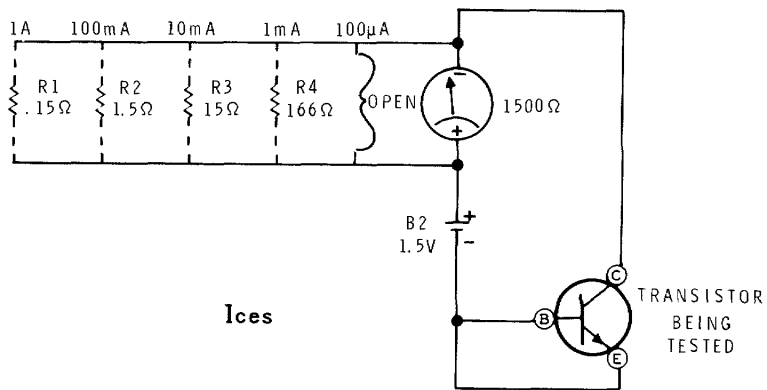

Figure 10

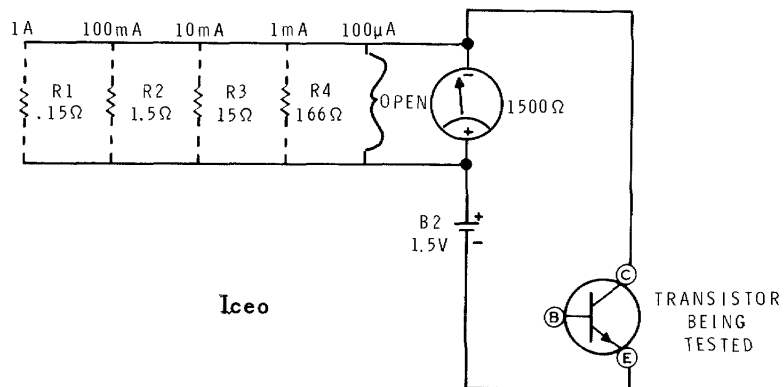
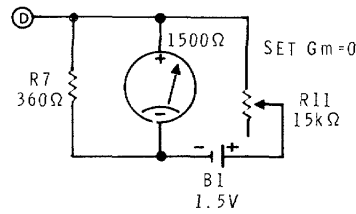
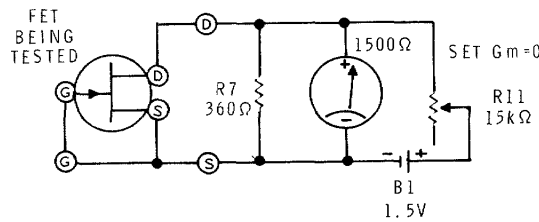

Figure 11





**Gm=0**  
**Figure 12**



**Gm**  
**Figure 13**

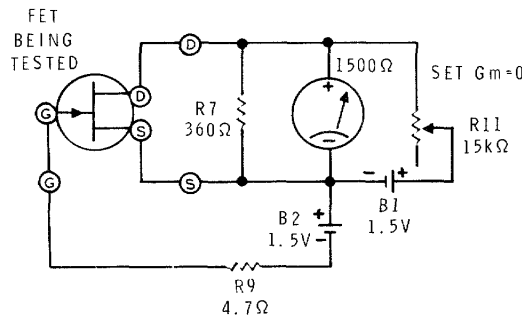

**GATE 1 / GATE 2**  
**Figure 14**

**Gm = 0**

Battery B1 and control R11 (Set Gm = 0) are placed in series with the meter and shunt resistor R7 as shown in Figure 12. This circuit forms a shunt type ohmmeter that will be used to measure the source-to-drain resistance in the Gm test. Control R11 is adjusted here to place the meter pointer over the 0 mark (full scale). Notice that the FET is not connected into the circuit at this time, even though it may be connected to the Tester.

**Gm**

Because Gm (transconductance) is the reciprocal of resistance, an ohmmeter type circuit can measure Gm. See

Figure 13. Notice that the Gm meter scale is similar to a typical ohmmeter scale.

In this test, the drain and source leads of the FET are connected in shunt with the meter. An FET with a low drain-to-source resistance has a Gm that approaches ∞. This is because the FET shunts most of the meter current. If the drain-to-source resistance is high, the Gm approaches 0. This is because the FET shunts very little meter current.

Typically, values of transconductance are expressed in μmhos (the meter indication multiplied by 1000).

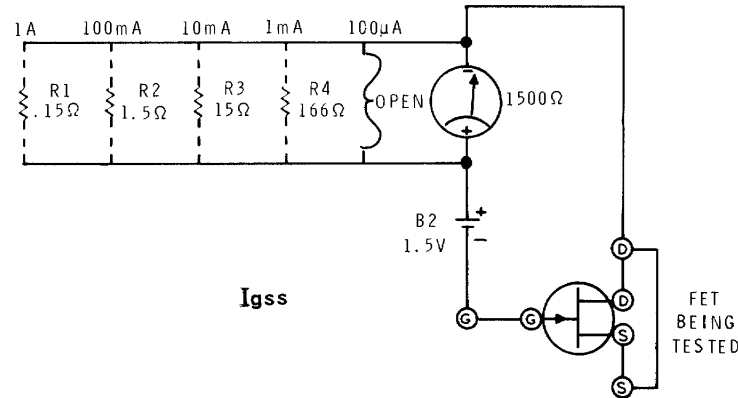

Figure 15

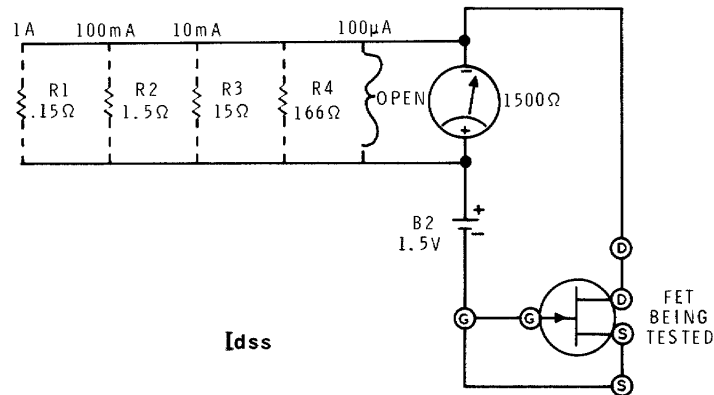

Figure 16

## GATE 1 AND GATE 2

The "Gate 1" circuit is similar to the  $G_m$  circuit. See Figure 14. However, the Gate 1 test places a reverse bias on the gate of the FET through resistor R9. This causes the channel of the FET to become electrically narrower, increasing its resistance, decreasing its  $G_m$ . A noticeable decrease in  $G_m$  should be apparent when the Gate 1 switch is pressed.

If the FET is a dual gate device, the Gate 2 switch will reverse bias the second gate. A noticeable decrease in  $G_m$  should also be apparent when the Gate 2 switch is pressed.

## $I_{gss}$ AND $I_{dss}$

Leakage currents are measured by placing a battery and the meter (and its shunt resistance) in series with two of the

FET leads. The meter indicates leakage current from 0 to 1 ampere, depending on the current range selected. Since the leakage currents are quite small, usually measured in microamperes ( $\mu A$ ), the FET must be removed from the circuit.

$I_{gss}$  is the measurement of the current that flows between the gate and the source of the FET with the drain connected to the source. See Figure 15.

$I_{dss}$  is the measurement of the current that flows between the drain and the source of the FET with the gate connected to the source. See Figure 16.

# CHASSIS PHOTOGRAPH

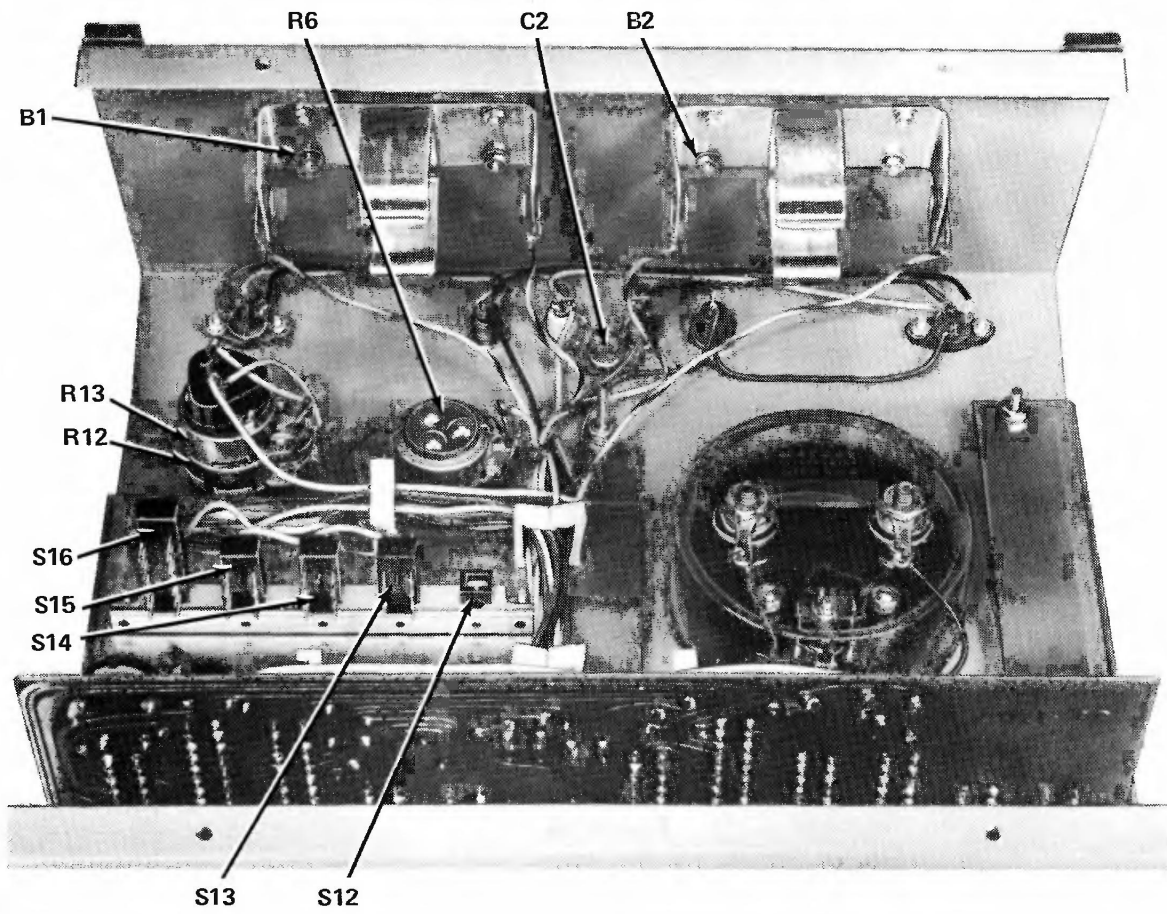

# CIRCUIT BOARD X-RAY VIEWS

NOTE: To identify a part shown in one of these Views, so you can order a replacement, proceed in either of the following ways:

1. A. Refer to the place where the part is installed in the Step-by-Step instructions and note the "Description" of the part (for example: 1500  $\Omega$  or .005  $\mu$ F).
  - B. Look up this Description in the "Parts List."
2. A. Note the identification number of the part (R-number, C-number, etc.).
  - B. Locate the same identification number (next to the part) on the Schematic. The "Description" of the part will also appear near the part.
  - C. Look up this Description in the "Parts List."

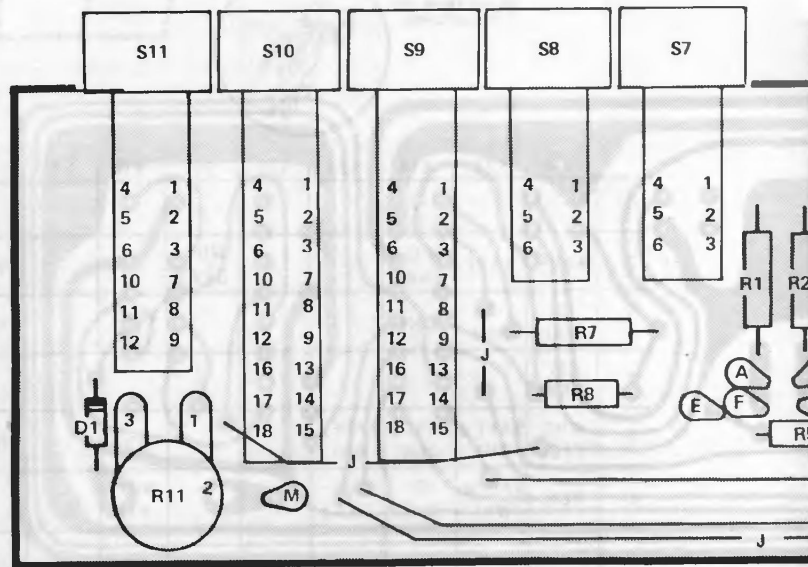

(VIEWED FROM FRONT)

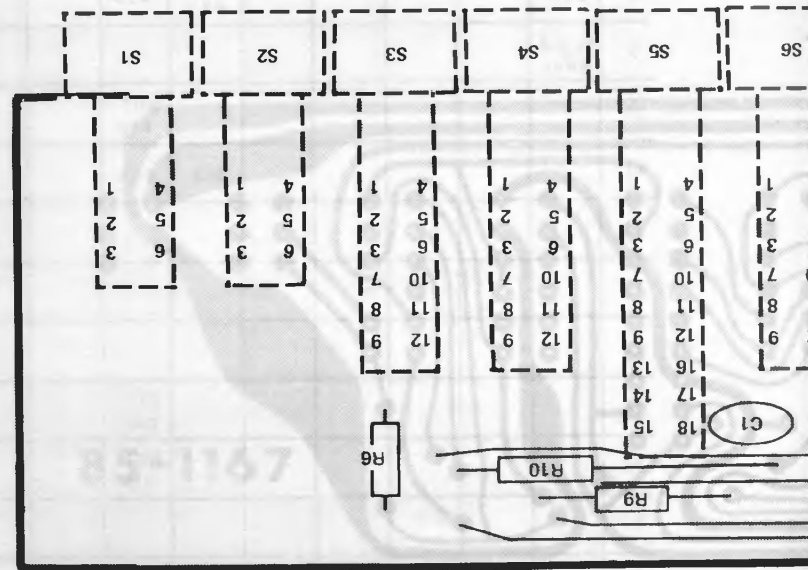

(VIEWED FROM REAR)



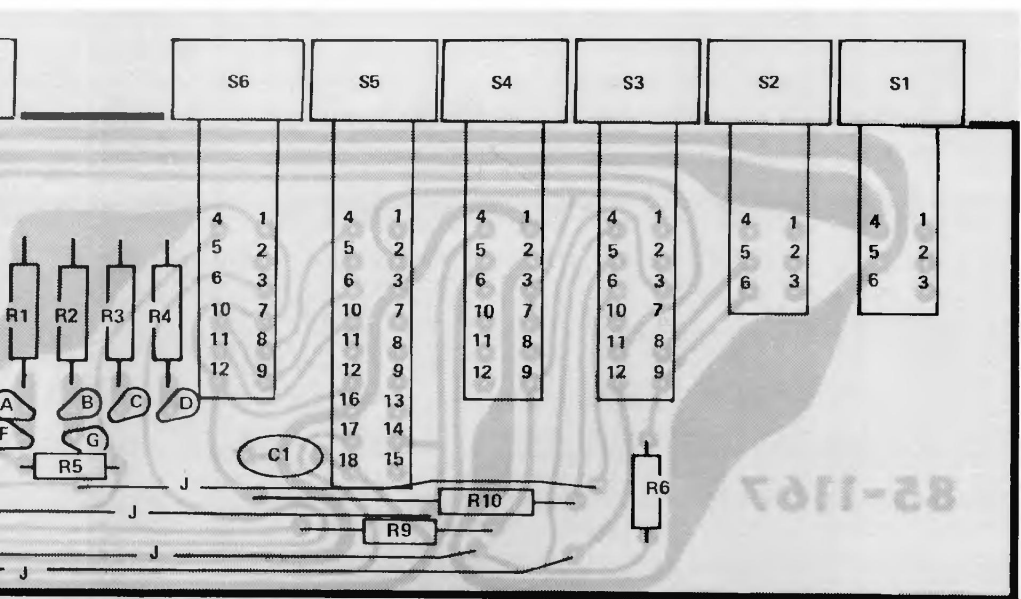

D FROM COMPONENT SIDE)

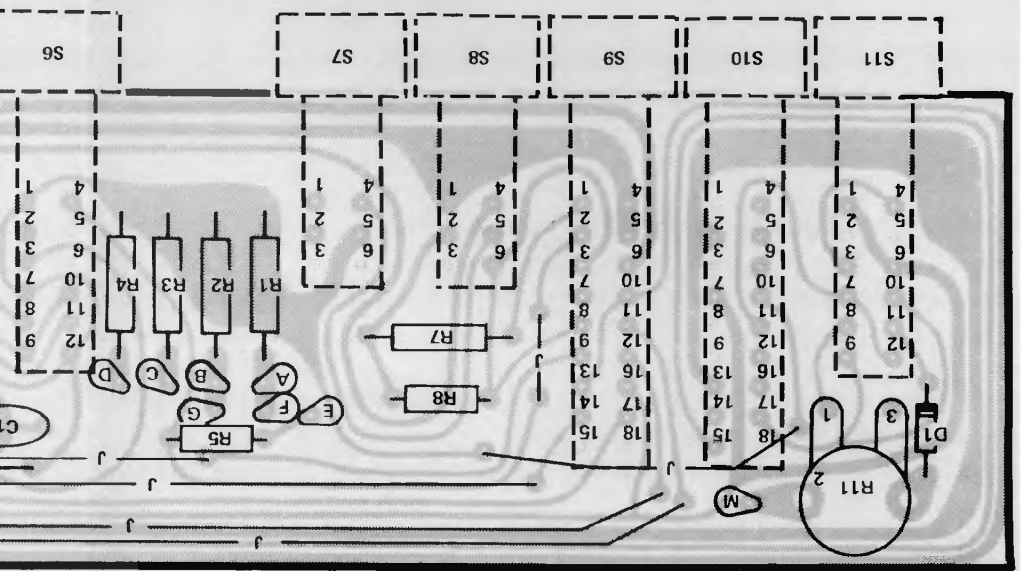

WED FROM FOIL SIDE)



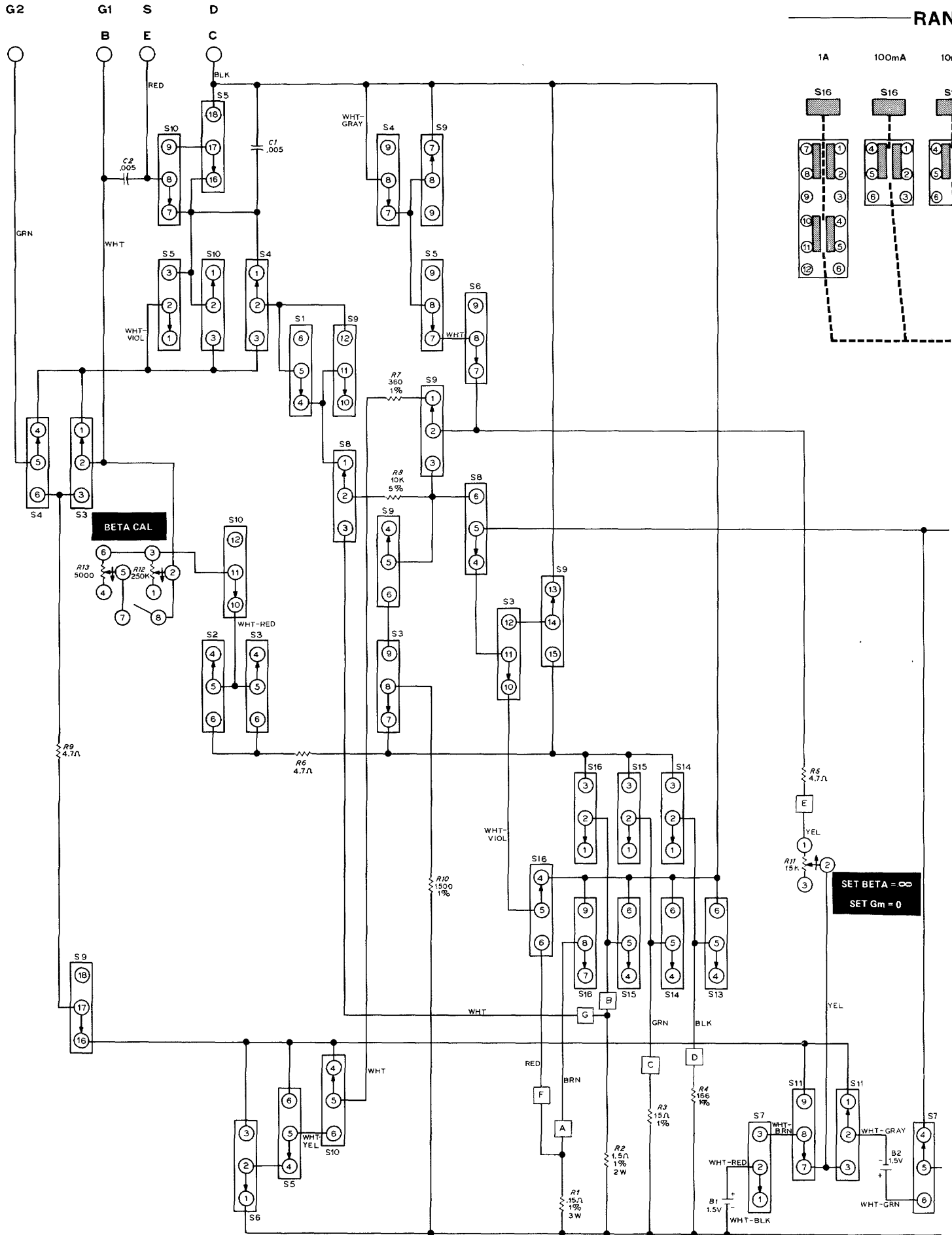



RANGE

MODE

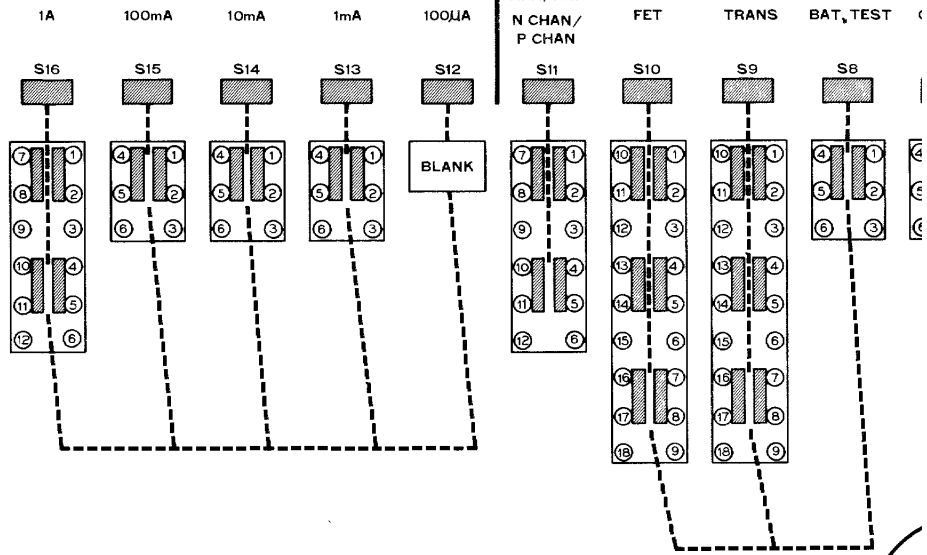

VIEWED FROM TOP OF SWITCHES

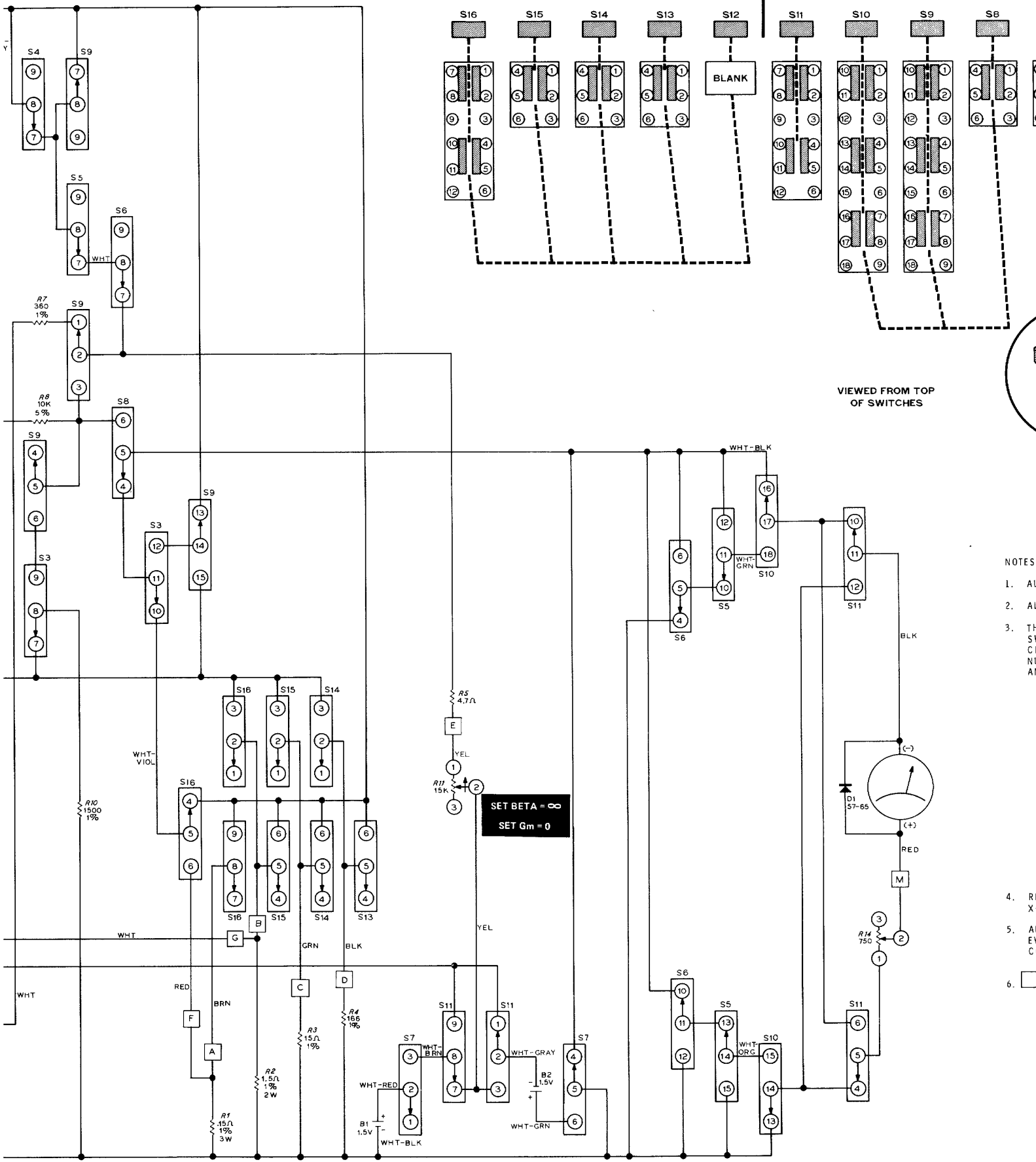

- NOTES:
1. ALL
  2. ALL
  3. THE SW CII NU AN

4. REI X-
5. ALI EVI CO
6. □

**RANGE**

**MODE**

**FUNCTION**

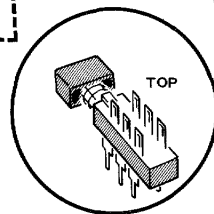
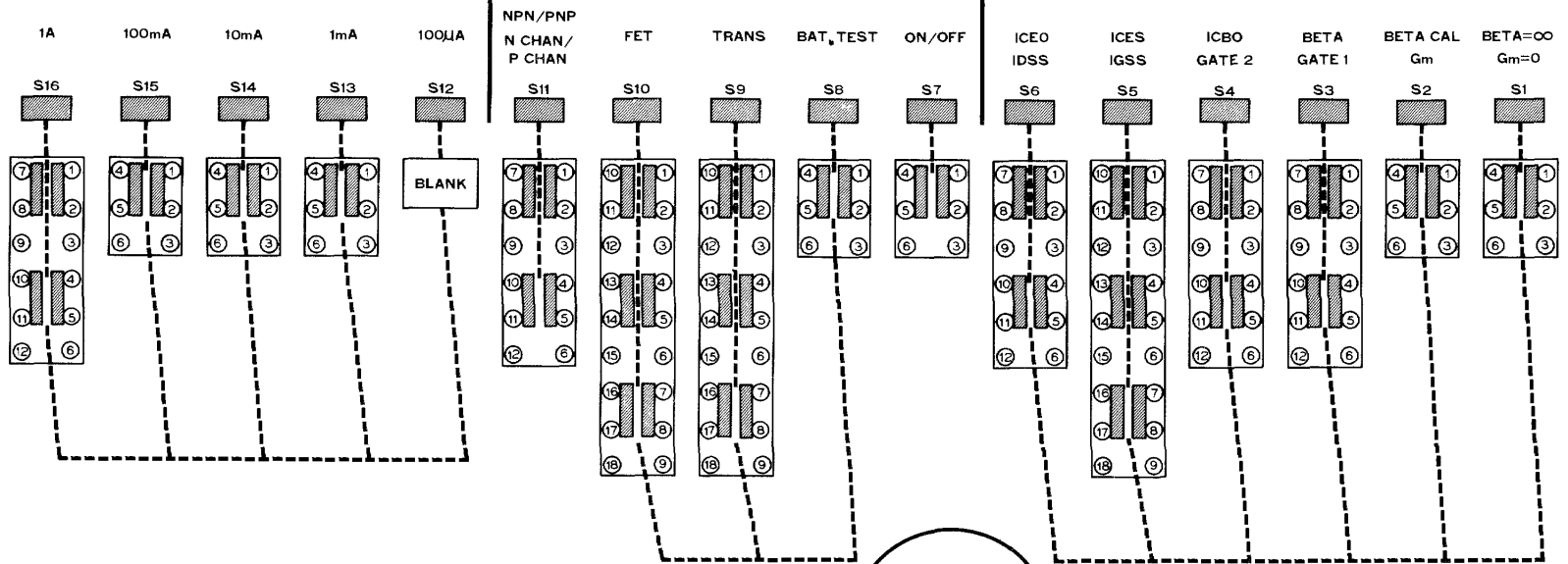

VIEWED FROM TOP OF SWITCHES

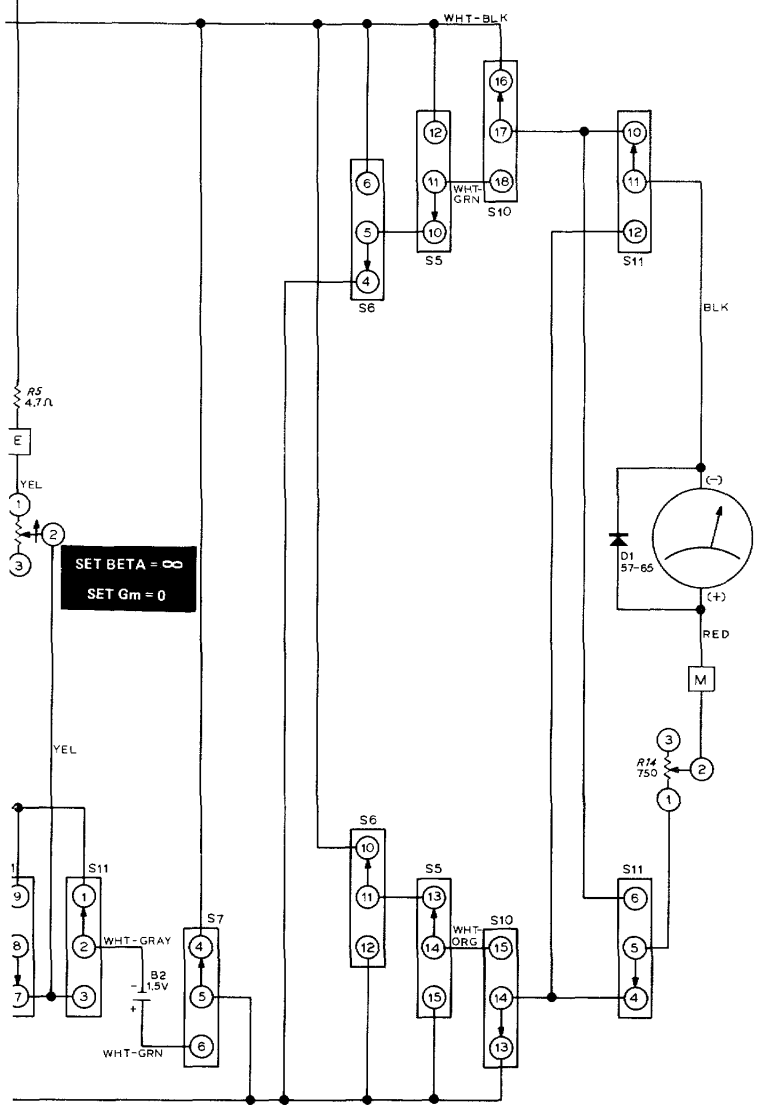

**SCHEMATIC OF THE HEATHKIT® FET/TRANSISTOR TESTER MODEL IT-121**

**NOTES:**

1. ALL RESISTORS ARE 1/2 WATT 5% UNLESS OTHERWISE SPECIFIED.
2. ALL CAPACITOR VALUES ARE IN  $\mu$ F.
3. THE ARROW INDICATES CLOCKWISE ROTATION OF A CONTROL OR SWITCH, AS VIEWED FROM THE KNOB END OR AS SHOWN FOR CIRCUIT BOARD CONTROLS. THE CIRCUIT BOARD CONTROL LUG NUMBERS CORRESPOND TO THOSE SHOWN ON THE SCHEMATIC AND X-RAY VIEWS.

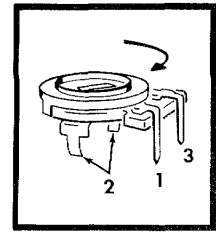







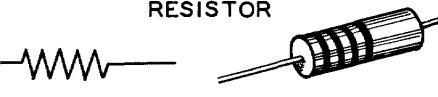
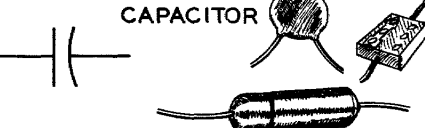
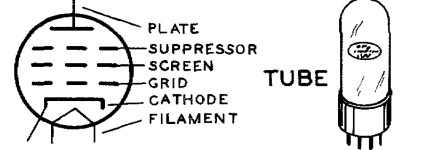
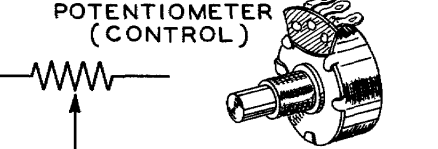
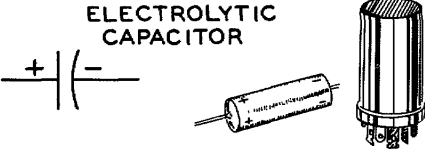
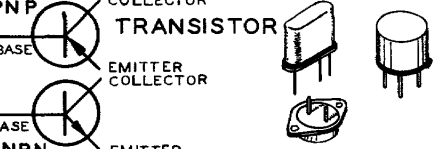
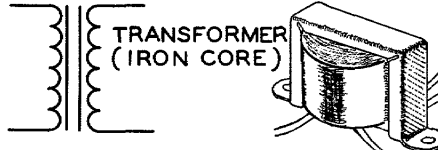
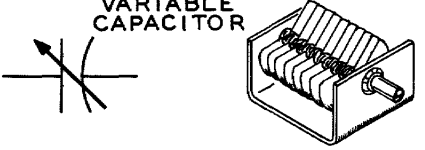
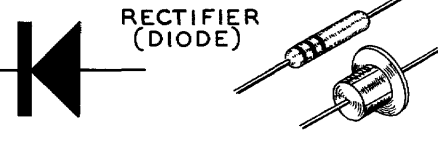
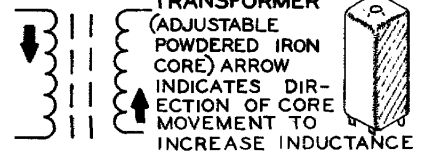
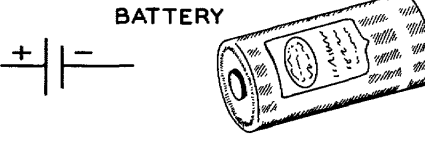
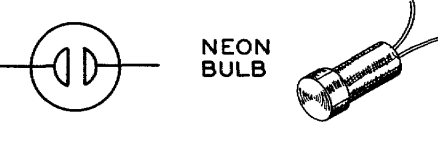
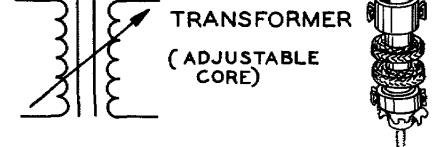
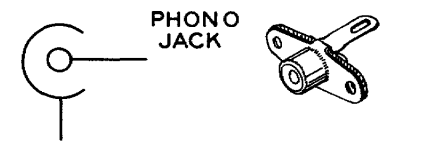
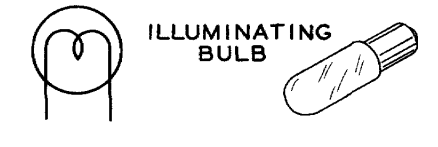
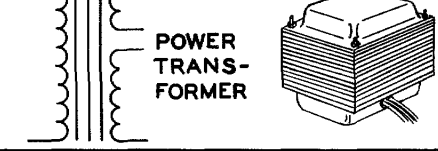
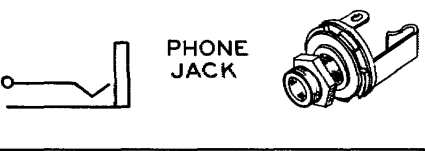
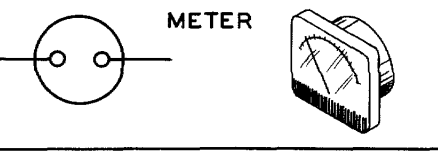
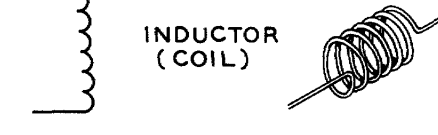

4. REFER TO THE CHASSIS PHOTOGRAPH AND CIRCUIT BOARD X-RAY VIEW FOR THE PHYSICAL LOCATION OF PARTS
5. ALL SWITCHES ARE SHOWN IN THE RELEASED (OUT) POSITION EVEN THOUGH THEY DO NOT REPRESENT A SPECIFIC OPERATING CONFIGURATION.
6. THIS SYMBOL INDICATES A LETTERED CIRCUIT BOARD CONNECTION.

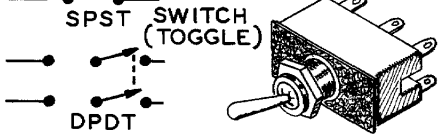
## TYPICAL COMPONENT TYPES

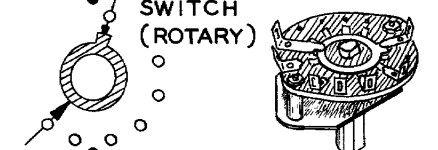
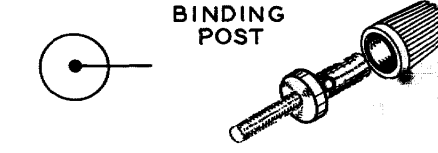
This chart is a guide to commonly used types of electronic components. The symbols and related illustrations

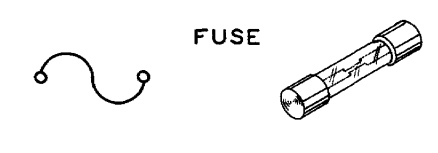
should prove helpful in identifying most parts and reading the schematic diagrams.

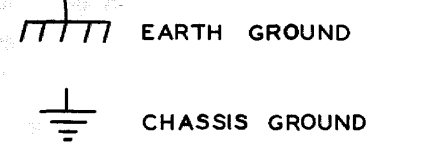
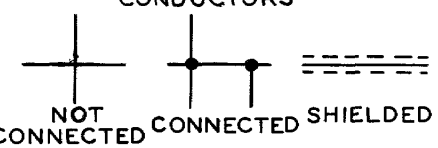
<p style="text-align: center;"><b>RESISTOR</b></p> 	<p style="text-align: center;"><b>CAPACITOR</b></p> 	<p style="text-align: center;"><b>TUBE</b></p> 
<p style="text-align: center;"><b>POTENTIOMETER (CONTROL)</b></p> 	<p style="text-align: center;"><b>ELECTROLYTIC CAPACITOR</b></p> 	<p style="text-align: center;"><b>TRANSISTOR</b></p> 
<p style="text-align: center;"><b>TRANSFORMER (IRON CORE)</b></p> 	<p style="text-align: center;"><b>VARIABLE CAPACITOR</b></p> 	<p style="text-align: center;"><b>RECTIFIER (DIODE)</b></p> 
<p style="text-align: center;"><b>TRANSFORMER (ADJUSTABLE POWDERED IRON CORE) ARROW INDICATES DIRECTION OF CORE MOVEMENT TO INCREASE INDUCTANCE</b></p> 	<p style="text-align: center;"><b>BATTERY</b></p> 	<p style="text-align: center;"><b>NEON BULB</b></p> 
<p style="text-align: center;"><b>TRANSFORMER (ADJUSTABLE CORE)</b></p> 	<p style="text-align: center;"><b>PHONO JACK</b></p> 	<p style="text-align: center;"><b>ILLUMINATING BULB</b></p> 
<p style="text-align: center;"><b>POWER TRANSFORMER</b></p> 	<p style="text-align: center;"><b>PHONE JACK</b></p> 	<p style="text-align: center;"><b>METER</b></p> 
<p style="text-align: center;"><b>INDUCTOR (COIL)</b></p> 	<p style="text-align: center;"><b>RECEPTACLE</b></p> 	<p style="text-align: center;"><b>SWITCH (TOGGLE)</b></p> 
<p style="text-align: center;"><b>PIEZOELECTRIC CRYSTAL</b></p> 	<p style="text-align: center;"><b>SPEAKER</b></p> 	<p style="text-align: center;"><b>SWITCH (ROTARY)</b></p> 
<p style="text-align: center;"><b>BINDING POST</b></p> 	<p style="text-align: center;"><b>MICROPHONE</b></p> 	<p style="text-align: center;"><b>FUSE</b></p> 
<p style="text-align: center;"><b>ANTENNA</b></p> <p style="text-align: center;">GENERAL      LOOP</p> 	<p style="text-align: center;"><b>EARTH GROUND</b></p> <p style="text-align: center;">CHASSIS GROUND</p> 	<p style="text-align: center;"><b>CONDUCTORS</b></p> <p style="text-align: center;">NOT CONNECTED      CONNECTED      SHIELDED</p> 

# HEATH COMPANY

BENTON HARBOR, MICHIGAN

**THE WORLD'S FINEST ELECTRONIC EQUIPMENT IN KIT FORM**

LITHO IN U.S.A.