

Assembly
and
Operation
of the

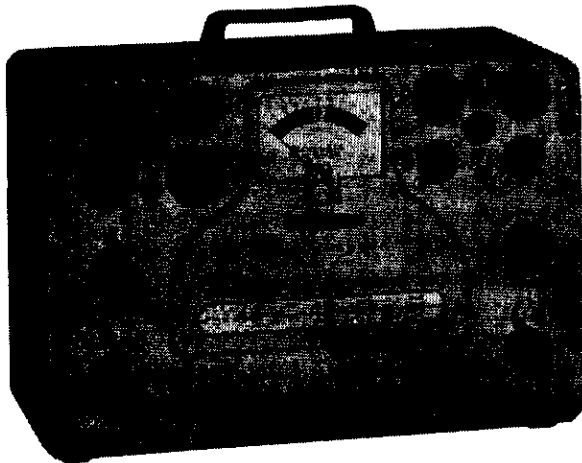

TUBE CHECKER

MODEL IT-17



HEATH COMPANY
BENTON HARBOR,
MICHIGAN 49022

TABLE OF CONTENTS

Specifications	2
Introduction	3
Construction Notes	6
Parts List	7
Proper Soldering Techniques	10
Step-By-Step Procedure	11
Step-By-Step Assembly	12
Testing	29
Cabinet Installation	29
Using Your Tube Checker	30
In Case Of Difficulty	32
Factory Repair Service	32
Replacement Parts Price List	35
Schematic. . .(fold-out from page)	35

SPECIFICATIONS

Tube Socket Accommodations	4 - pin. 5 - pin. 5 - pin Nuvistor. 6 - pin. 7 - pin combination and pilot lamp. 7 - pin miniature. 7 - pin Nuvistor. 8 - pin octal. 8 - pin loctal. 9 - pin miniature. 9 - pin Novar. 10- pin miniature. 12- pin Compactron.
Controls.	FILAMENT VOLTAGE SET LINE TYPE PLATE
Element Test Voltages.	30, 100, and 250 volts AC.
Filament Voltages.63, 1.4, 2, 2.35, 2.5, 3.15, 4.2, 4.7, 5, 6.3, 7.5, 9.45, 12.6, 19.6, 25, 32, 50, 70, and 110 volts AC.
Roll Chart Mechanism.	Constant tension, free rolling, thumbwheel operated, illuminated.
Line Voltage Adjustment.	Step type.
Meter.	1 milliampere full scale, BAD - ? - GOOD scale, illuminated.
Tests Available.	Emission, Short, Leakage, Open Element, and Filament continuity.
Power Requirements.	105-125 volts 50/60 cps AC.
Dimensions.	13" wide x 8-1/2" high x 5-1/2" deep.
Net Weight.	9 lbs.

The Heath Company reserves the right to discontinue instruments and to change specifications at any time without incurring any obligations to incorporate new features in instruments previously sold.

INTRODUCTION

A vacuum tube possesses a number of operating characteristics, any one of which may be used to indicate, to a limited degree, the operational capabilities of the tube. Any number of tube testing devices are available, utilizing one or more of these characteristics, each one subject to its own limitations. It is universally recognized that no tube tester can provide a complete and accurate account of the condition existing within a given vacuum tube when that tube is in operation in the receiver. If maximum benefit is to be obtained from a tube tester, regardless of its design, two things should be known: (1) the requirements placed on the tube, and (2) the limitations of the tube tester. With this thought in mind, we have listed some of the more commonly used methods of tube testing.

EMISSION TESTING

Testing the emission capabilities of the cathode provides the simplest and most economical means of determining the overall quality of a vacuum tube. This is accomplished by connecting all the grids to the plate and operating the tube as a rectifier. The actual emission of the cathode is then compared to a predetermined value accepted as standard for that tube type. If the cathode should have one particularly active portion, the emission checker will indicate the quality of the tube to be good, even though the remainder of the cathode may be inactive. On the other hand, modern coated cathodes are capable of large emission, often far in excess of the emission required for the particular application. In some cases the emission checker will indicate the quality of the tube to be questionable or even unacceptable. This tube may not function in an application requiring a large emission but would probably operate satisfactorily for a long time in a circuit where the emission requirements are less.

TRANSCONDUCTANCE TESTING

A transconductance tester places a standard voltage on each tube element, creating a plate current flow. Measurement of this plate current will indicate the transconductance of that particular tube under static conditions. Here again, since the tube is not operating exactly as it does in the receiver, the test may be termed inconclusive. An improved version of the transconductance test is available in the dynamic transconductance tester.

DYNAMIC TRANSCONDUCTANCE TESTING

The dynamic transconductance of a tube is measured by using the circuit of the static transconductance tester and adding a signal generator. By applying a signal to the tube under test, the action of the plate current will be similar to that experienced in the receiver, varying in relationship to the input signal. Although this system gives an indication of how the tube will operate under signal conditions, it is still limited in scope. Certain types of tubes cannot be satisfactorily checked on any type of tester, even the dynamic transconductance tester. Particular offenders in this respect are tubes used in the vertical and horizontal deflection circuits of television receivers. The only method of accurately checking these tubes is by set testing.

SET TESTING

No tube tester is required in this system of tube testing; simply insert a new tube in the receiver and observe the results. At first glance this appears to be the most inexpensive testing system available. Bear in mind, however, that if all tubes were to be tested in this manner, a stock of tubes representing an investment of several hundred dollars is required.

POWER OUTPUT TESTING

This testing system is perhaps the most satisfactory in regards to similarity between test results and actual operation in the receiver. Since both the input and output powers are known, the other factors can be determined. In the case of voltage amplifiers the voltage amplification and output voltage will be of prime interest. The power output test is ideally suited to testing power amplifiers, where the output power is of major concern.

LOW LINE TEST

In this testing system the input voltage to the receiver is lowered to 105 volts. Sufficient time should be allowed (10 minutes) for the tube heaters to stabilize. If the questionable tube fails to function properly it should be replaced.

INSTRUMENT DESCRIPTION

In designing a tube checker, the designer is faced with the problem of deciding which of the

above mentioned testing procedures to follow. Points that must be considered are the cost, relative merits of each system, and the net value to the purchaser. On the basis of these and other considerations, the HEATHKIT Tube Checker has been designed around the emission testing circuit. There are several reasons for this decision, some of which are: (1) the emission checker will provide the best overall indication of tube quality when compared with other types on a cost per unit basis, (2) the transconductance of a tube is dependent upon cathode emission, (3) some busy servicemen do not wish to take the time necessary to check the tube thoroughly. They plug in the tube, push the button and observe the meter to check the emission; if the emission of the tube is too low for the intended service, determining any of the other characteristics is a waste of valuable time, (4) the emission testing circuit is relatively simple, requires few components, and lends itself well to kit-type construction, and (5) the low selling price made possible by the use of this circuit more than compensates for any inherent shortcomings it may possess. We sincerely believe the HEATHKIT Tube Checker will give the most test information per dollar invested.

The action of the instrument has been made quite flexible by the use of multiple filament voltages, adjustable cathode current, variable meter sensitivity and individual element switching. The thirteen lever switches make it possible to connect any element to any other element, regardless of the pin numbers involved.

The instrument may be used in darkened areas (such as the inevitable dark corner behind the TV receiver) with ease since both the roll chart and the meter are illuminated.

No difficulty should be experienced in roll chart operation on the part of the left-handed operator. Thumbwheel drive knobs have been provided on both sides of the panel to eliminate any "cross-over" problems. The roll chart mechanism is a unique design which permits the roll chart to run freely throughout its entire length without binding. The chart rollers are spring loaded to keep the chart taut at all times to present a smooth viewing surface.

TUBE TYPE ACCOMMODATIONS

The HEATHKIT Tube Checker was designed for

checking tubes encountered in everyday radio and TV service work, but is not specifically limited to these types. It will check satisfactorily any tube that can be accommodated in the tube sockets if the data provided by the tube manufacturer is available. Sockets provided are: 4-pin, 5-pin, 5-pin Nuvistor, 6-pin, 7-pin combination and pilot lamp, 7-pin miniature, 7-pin Nuvistor, 8-pin octal, 8-pin loctal, 9-pin Novar, 10-pin miniature, and 12-pin Compactron.

The 10-pin miniature socket is constructed so that it can also be used to check 9-pin miniature tubes.

ROLL CHART DATA

The roll chart contains necessary data for the checking of currently used tubes. But it is not always possible to furnish a roll chart that has all the latest tubes on it, because of the constantly growing list of tubes and the time it takes to obtain sample tubes, conduct tests, and publish roll charts. Therefore, to keep your roll chart up to date, you may be interested in subscribing to the Heathkit Tube Test Data Service, which will regularly supply you with the latest data for newly released tubes. To subscribe to this service, fill out and send in the Heathkit Tube Test Data Service Card.

FILAMENT VOLTAGES

Filament voltages used in the operation of the tube checker are derived from a secondary winding on the power transformer which is tapped to provide nineteen different voltages. These voltages are switch selected for convenience of operation and assure the application of the proper filament voltage for a given tube type under test.

TEST VOLTAGES

Voltages used in the various tests provided by the Tube Checker are derived from a secondary winding on the power transformer which is tapped at 30, 100, and 250 volts. During the operation of the Checker, three basic circuits are set up using these voltages.

LINE TEST CIRCUIT

The first basic circuit, Figure 1, is in use when the TEST switch is in the SHORT ADJUST position. The SET LINE switch in the primary of the power transformer varies the voltage across the primary, thus controlling the voltage across both secondary windings simultaneously. The

meter, with the voltage divider and rectifier network now in the circuit, will indicate the proper secondary voltage when the needle is within the LINE TEST block. The purpose of the SET LINE switch is to assure proper voltages on the tube under test, thus minimizing the possibility of an erroneous indication due to abnormally high or low power line voltages.

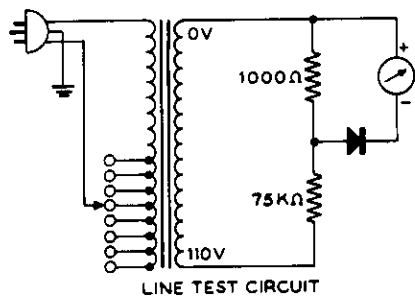

Figure 1

SHORT TEST CIRCUIT

The second basic circuit, Figure 2, is used in the short, leakage, and filament continuity tests. The 100 volt tap is connected to the neon short indicator and associated network and is in series with the plate of the tube under test. The meter is not in the circuit; the tests are indicated by the neon lamp. Moving the lever switches in the prescribed manner connects the tube elements in such a manner that a shorted element will cause considerable increased current flow through the resistor in parallel with the neon lamp. The voltage drop then produced reaches the operating voltage of the neon lamp causing it to glow, thus indicating a short. For the leakage test, the circuit remains unchanged in all respects except one: the value of the resistance in parallel with the neon lamp is increased, thus increasing the sensitivity of the test. The term "short" as used in this test should not be confused with the direct short formed by connecting two terminals with a piece of wire. The sensitivity rating of the short test is 250 KΩ, which means the lamp will glow if the resistance between the shorted elements is anywhere between the values of 0 and 250,000 ohms. The sensitivity rating of the leakage test (high-sensitivity short test) is 2 megohms which means that the lamp will glow if the resistance is anywhere between 0 and 2,000,000 ohms. Actually, this test may be altered to any desired sensitivity by replacing the 2.2 megohm

resistor with the required value. The short test is a very critical test and should be performed carefully and evaluated in terms of the amount of leakage which can be tolerated in the circuit.

Figure 2

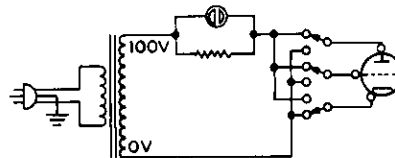

QUALITY TEST CIRCUIT

The third basic circuit, Figure 3, is used when making the quality and open element tests. The plate and grids are connected together to the 30 volt transformer tap. The filament and cathode are connected together to the 0 volt tap of the high voltage winding through the PLATE control. The PLATE control adjusts the sensitivity of the meter, which is in the circuit at this time. The tube now conducts as a half-wave rectifier, the total emission of the cathode being passed to a single terminal (anode) and out through the meter circuit.

A good tube, with the sensitivity of the meter properly adjusted, will have sufficient cathode emission to swing the meter needle into the GOOD section of the scale. If the emission is too low, the current through the tube will not be high enough to bring the needle into the GOOD section; it will remain in the (?) section or drop into the BAD section.

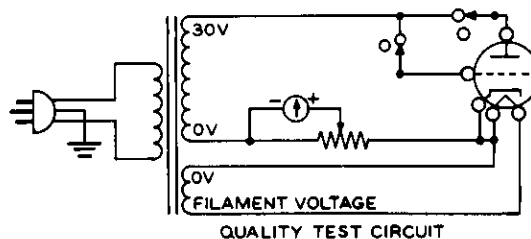

Figure 3

An open element may be detected in the following manner. Since all tube elements (except cathode) are connected to the plate terminal, the current indicated by the meter during the quality test represents the total current through the tube. Disconnecting an element from the plate terminal will cause the current through the tube to diminish. The meter reading will then be less than originally noted. Therefore, a drop in the meter reading indicates the ele-

ment is not open. If the element were open, disconnecting it from the plate terminal would make no change in the tube current, hence no change in the meter reading. For tubes with a number of grids, the operation is somewhat more complex, but the same theory applies in general. For gas tubes (OZ4, etc.) the 250 volt tap is used instead of the 30 volt tap. The rest

of the circuitry remains unchanged.

The TYPE switch places the appropriate resistance value in the plate circuit of the tube under test to limit the cathode-current. This switch also changes the meter sensitivity to obtain the proper meter deflection for this value of cathode current.

CONSTRUCTION NOTES

This manual is supplied to assist you in every way to complete your kit with the least possible chance for error. The arrangement shown is the result of extensive experimentation and trial. If followed carefully, the result will be highly stable and dependable performance. We suggest that you retain the manual in your files for future reference, both in the use of the equipment and for its maintenance.

UNPACK THE KIT CAREFULLY AND CHECK EACH PART AGAINST THE PARTS LIST. In so doing, you will become acquainted with the parts. Refer to the information on the inside covers of the manual to help you identify the components. If some shortage or parts damage is found in checking the Parts List, please read the Replacements section and supply the information called for therein.

Resistors generally have a tolerance rating of

10% unless otherwise stated in the Parts List. Tolerances on capacitors are generally even greater. Limits of +100% and -20% are common for electrolytic capacitors.

We suggest that you do the following before work is started:

1. Lay out all parts so that they are readily available.
2. Provide yourself with good quality tools. Basic tool requirements consist of a screwdriver with a 1/4" blade; a small screwdriver with a 1/8" blade; long-nose pliers; wire cutters, preferably separate diagonal cutters; a penknife or a tool for stripping insulation from wires; a soldering iron (or gun) and rosin core solder. A set of nut drivers and a nut starter, while not necessary, will aid extensively in construction of the kit.

Most kit builders find it helpful to separate the various parts into convenient categories. Muffin tins or molded egg cartons make convenient trays for small parts. Resistors and capacitors may be placed with their lead ends inserted in the edge of a piece of corrugated cardboard until they are needed. Values can be written on the cardboard next to each component. The illustration shows one method that may be used.

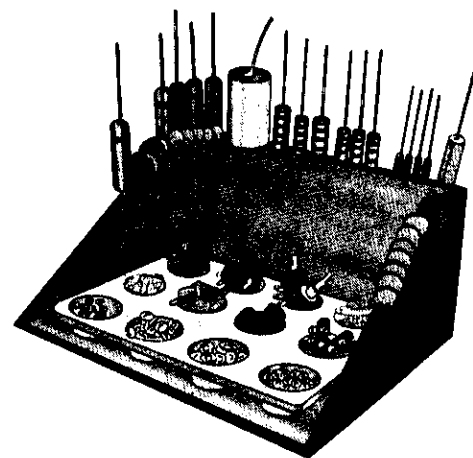

USING YOUR TUBE CHECKER

The instrument you have just completed will provide a variety of tests to indicate the relative value of the particular tube being checked. The following steps may be used as a guide in setting up tube testing procedures. Remember that the ultimate value of any measuring device is dependent upon the skill of the operator and, more important, his ability to properly evaluate the information provided by the instrument.

1. With the power cord connected, move the roll chart to the listing of the tube to be tested. If an asterisk (*) appears after the tube designation, refer to the proper note at the bottom of the roll chart. Turn the SET LINE control until the meter pointer falls within the LINE TEST block.
2. Set the TYPE switch to the number shown on the chart.
3. Set the FILAMENT selector to the voltage shown on the chart.
4. Set the PLATE control according to the chart information.
5. Set the LEVER switches to the T-TOP and B-BOTTOM positions as shown in the top and bottom columns on the chart.
6. If the tube being tested has a plate or grid cap extending from the top of the tube, connect the clip at the upper right of the panel to this cap.
7. Insert the tube and reset the SET LINE control if necessary. (Pin positions and keyways determine tube positioning on all sockets.)
8. Check the tube for shorts by moving the levers shown in light type through the two positions, returning to the position shown on the chart. The TEST switch remains in the SHORT position for this test. The SHORT-LEAKAGE switch should be in the SHORT position. A shorted tube is indicated by a steady glow of the neon lamp. Disregard neon lamp flashing as the lever switches are moved. It is possible that some serious short circuits will momentarily overload the power transformer. This condition will be indicated by

complete dim out of the panel lamps. Do not allow the Tube Checker to operate under this extreme condition for any length of time. Make the test as quickly as possible in order to obtain the desired information.

9. Check the tube for leakage between elements by moving the SHORT-LEAKAGE switch to the LEAKAGE position and repeating the short test as outlined above.
 10. After allowing sufficient time for the tube to reach operating temperature, check for quality by moving the test slide switch to the TEST position. If the meter pointer falls in the GREEN scale, the quality of the tube is GOOD.
 11. Check for open elements as follows: holding the slide switch in the TEST position, move each lever in the TOP position (only those shown in light type) to the BOTTOM position and return. Satisfactory tube elements (those properly connected to their pins) are indicated by a decrease in meter reading. The grid element usually shows a large decrease, while a screen or plate may show only a slight decrease.
- NOTE: If the meter indication in the quality test is off scale, reduce the meter reading to an on-scale reading by turning the PLATE control counterclockwise, then proceed with the open element test.
12. To check filaments, filament taps and internal connections for continuity, set the FILAMENT selector to .63 volts. Move each lever shown in dark type through each of its other two positions. Always move only one lever at a time. Satisfactory filaments, taps, and internal connections will be shown by a bright glow of the SHORT test indicator.

In any of the above tests, should the tube prove to be faulty in some respect, the defective element can be traced by comparing the lever switch in question with a base diagram of the tube. Lever switch A corresponds to tube pin 1, lever switch B to tube pin 2, etc.

Multiple tube types (tubes which contain more than one set of elements) are indicated on the chart by a bracket set of listings, one for each test to be made on the tube. The Checker is set up according to the test in each line and checked through all of the test as outlined in the preceding steps.

Check pilot lamps by setting the **FILAMENT** selector to the proper voltage and inserting the pilot lamp in the socket found in the center of the large 7-pin socket. This is a universal type pilot lamp test socket and does not require that the lamp be permanently inserted. It is only necessary to hold the pilot lamp so that the side wall of the base and the center pin of the lamp make contact with the corresponding points in the lamp socket.

NEW TUBES

We annually revise the Tube Checker roll chart in order to keep abreast of new tube releases. However, because of the great quantity of new tubes being released by manufacturers, a customer will occasionally desire to check a new tube before the test data appears on the roll chart.

The following instructions indicate how to set up the instrument for obtaining temporary settings so that these new tubes may be checked (provided manufacturer's data is available).

1. Note manufacturer's data carefully concerning the base diagram of the pin connections and filament voltage.
2. Set the Tube Checker **TYPE** switch as follows:
 - Type 1 - for low cathode current tubes (below 4 ma), usually diode types.
 - Type 2 - for tube types with cathode current between 3 ma and 15 ma. These are usually filament type tubes with the exception of diodes.
 - Type 3 - for tube types with cathode current greater than 8 ma. These are usually indirect-heated cathode types with the exception of diodes.
 - Type 4 - for gas control tubes, gaseous rectifiers, and eye or target tubes.
3. Set **FILAMENT** voltage to the value specified by manufacturer.
4. Set all levers to the **CENTER** position.
5. Determine the first filament connection from the tube base diagram and leave its connection lever in the **CENTER** position. Its connection lever corresponds to the letter on the lever - A corresponds to pin 1, B to pin 2, C to pin 3, etc.
6. Determine the second filament connection from the tube base diagram and set its connection lever to the **BOTTOM** position.
7. Determine from base diagram if the tube has a filament tap. The position of the lever corresponding to the filament tap will depend upon the placement of the tap in respect to the other filament connections. Some filament taps are placed in the center of the filament, as in the 12AU7. For this type filament, the two outer terminals (pins 4 and 5) are connected to one side of the filament supply (levers in **CENTER** position) and the tap is connected to the other side (lever in **BOTTOM** position). The **FILAMENT** control is then set at $1/2$ the voltage rating of the entire filament, or (in this case) $12.6/2 = 6.3$ volts. When the filament tap is not symmetrically located, as in the 35Z5, the tap must be connected to that end of the filament which is electrically nearer the tap position. For the 35Z5, pins 2 and 3 should be connected to one side of the filament supply and pin 7 to the other. The **FILAMENT** control is then set to the voltage closest to that recommended by the tube manufacturer, in this case 32 volts.
8. If the tube has more than one section (duo-diodes, duo-triodes, etc.) make a separate test for each section. For the section being tested, follow the instructions below. For the section not being tested, move all corresponding connection levers to the bottom position. If the tube has only one section, follow the instructions below.
9. Move the connection lever corresponding to the cathode to the **BOTTOM** position.
10. Move all other elements of the section being tested (screens, suppressors, grids, etc.) to the **TOP** position.
11. Plug the tube into the correct socket.
12. Plug the line cord into the power supply and turn the instrument on.
13. Adjust the **SET LINE** control until the meter pointer falls in the **LINE TEST** block.
14. Hold the **ADJUST LINE SHORT-TEST** switch in the **TEST** position and adjust the **PLATE** control to bring the pointer to the middle of the **GOOD** scale. (If possible, make this adjustment for at least three new tubes of the same type and select the average setting.)



15. List all these settings in the space provided in the chart on Page 33 of this Manual.
16. If the tube is of the multi-section type, check the remaining sections in the manner outlined and list the settings in the chart.

IN CASE OF DIFFICULTY

1. Recheck the wiring. Trace each lead in colored pencil on the Pictorial and Schematic Diagram as it is checked. It is frequently helpful to have a friend check your work. Someone who is not familiar with the unit may notice something consistently overlooked by the constructor.
 2. It is interesting to note that about 90% of the kits that are returned for repair, do not function properly due to poor connections and soldering. Therefore, many troubles can be eliminated by reheating all connections to make sure that they are soldered as described in the Proper Soldering Techniques section of this manual.
 3. Check the values of the component parts. Be sure that the proper part has been wired into the circuit, as shown in the pictorial diagrams and as called out in the wiring instructions.
 4. Check for bits of solder, wire ends or other foreign matter which may be lodged in the wiring.
 5. Check the voltages in the manner outlined under TESTING. This may help to show up a misinterpretation of the transformer lead identification code.
 6. Make continuity checks between the lever switch common lugs and the various socket pins to make sure that all contacts are properly connected to the lever switches. (Pin 1 of each socket corresponds to lever switch A, pin 2 to lever switch B, etc.)
- NOTE: In an extreme case where you are unable to resolve a difficulty, refer to the Service and Warranty section of the "Kit Builders Guide", and to the "Factory Repair Service" information on this page.

FACTORY REPAIR SERVICE

You can return your completed kit to the Heath Company Service Department to have it repaired for a minimum service fee. (Kits that have been modified will not be accepted for repair.) If you wish, you can deliver your kit to a nearby Heath Authorized Service Center. These centers are listed in your Heathkit catalog.

To be eligible for replacement parts under the terms of the warranty, equipment returned for factory repair service, or delivered to a Heath Authorized Service Center, must be accompanied by the invoice or the sales slip, or a copy of either. If you send the original invoice or sales slip, it will be returned to you.

If it is not convenient to deliver your kit to a Heath Authorized Service Center, please ship it to the factory at Benton Harbor, Michigan and follow the following shipping instructions:

Prepare a letter in duplicate, containing the following information:

- Your name and return address.
- Date of purchase.
- A brief description of the difficulty.

- The invoice or sales slip, or a copy of either.
- Your authorization to ship the repaired unit back to you C.O.D. for the service and shipping charges, plus the cost of parts not covered by the warranty.

Attach the envelope containing one copy of this letter directly to the unit before packaging, so that we do not overlook this important information. Send the second copy of the letter by separate mail to Heath Company, Attention: Service Department, Benton Harbor, Michigan.

Check the equipment to see that all parts and screws are in place. (Do not include wooden cabinets when shipping receivers, tuners, amplifiers, or TV sets, as these are easily damaged in shipment.) Then, wrap the equipment in heavy paper. Place the equipment in a strong carton, and put at least THREE INCHES of resilient packing material (shredded paper, excelsior, etc.) on all sides, between the equipment and the carton. Seal the carton with gummed paper tape, and tie it with a strong cord. Ship it by prepaid express, United Parcel Service, or insured parcel post to:

Heath Company
Service Department
Benton Harbor, Michigan 49022

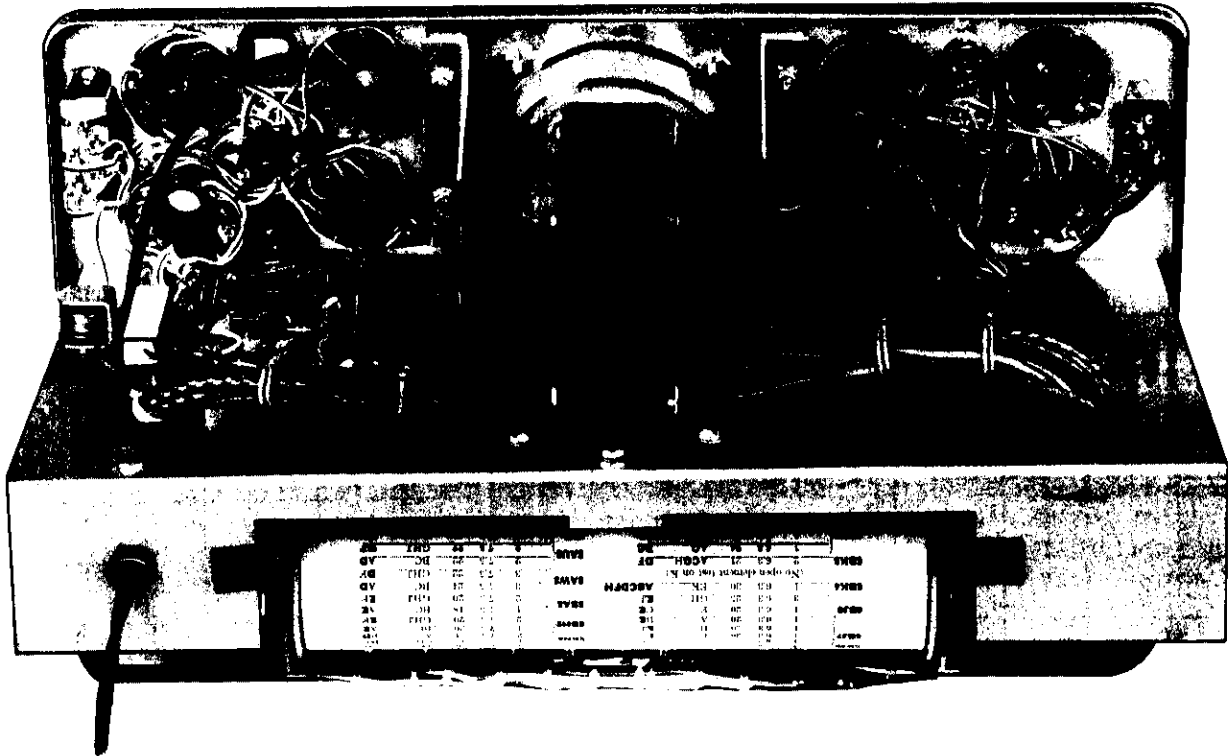
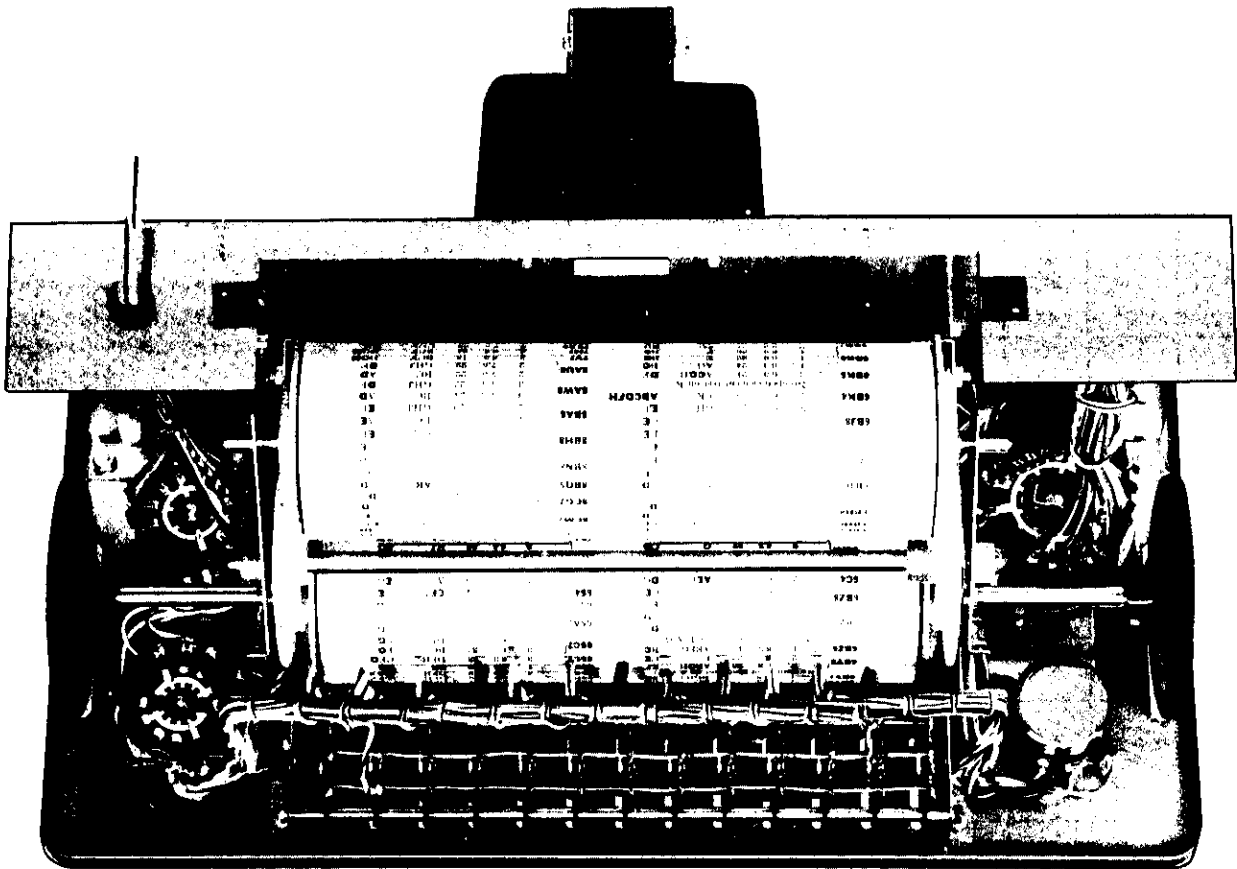

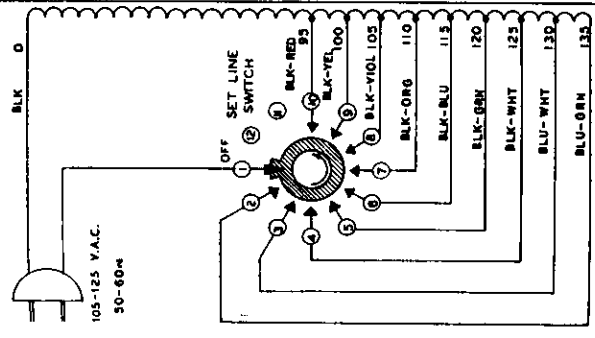
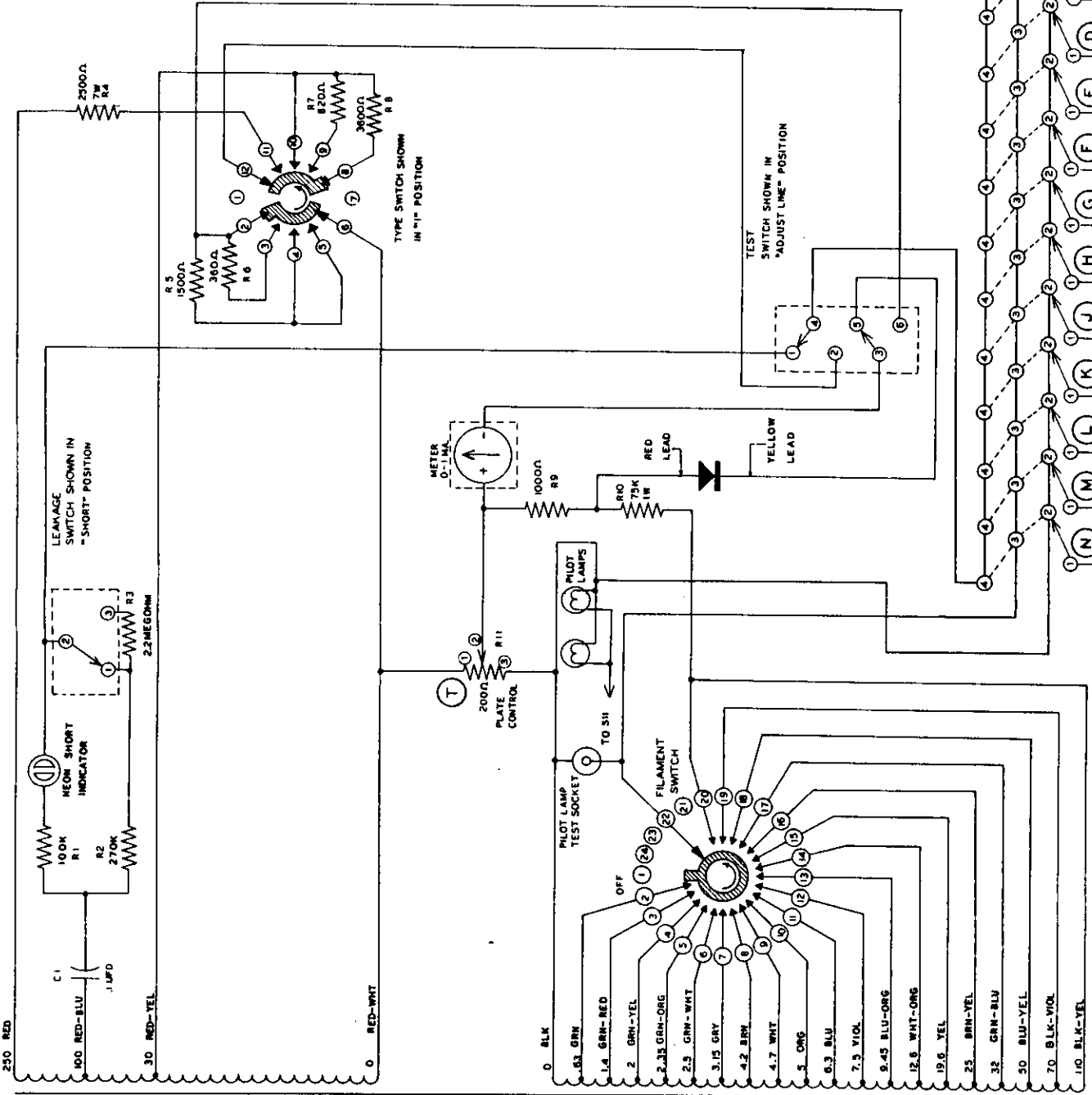

LINE AND FILAMENT SWITCHES

SHOWN IN "OFF" POSITION.

**SCHEMATIC OF THE
HEATHKIT
MODEL IT-17**

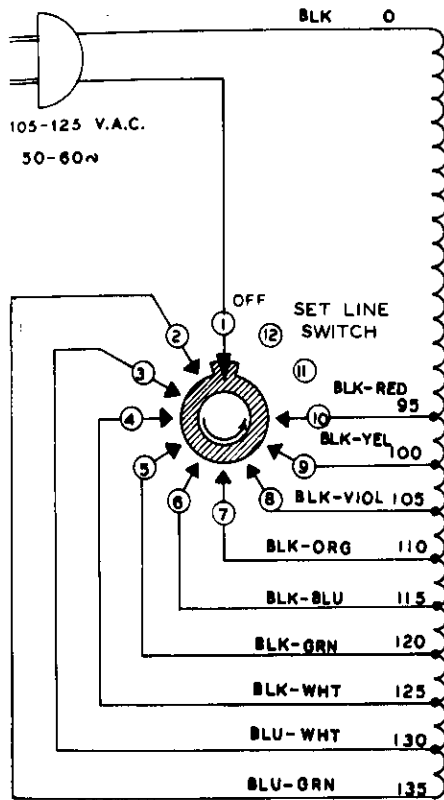

LINE AND FILAMENT SWITCHES
SHOWN IN "OFF" POSITION.

**SCHEMATIC OF THE
HEATHKIT
MODEL IT-17**

