

MAY 1924

# RADIO BROADCAST

25 CENTS

Building a Resistance-Coupled Amplifier

"Who's To Pay?"—\$500 Prize Contest

"As It Was In The Beginning"

Reflexing Your "Bloopers"



WARRANTED



C-300—6 Volts Gas Content Detector \$5.00



C-12—Similar to C-11 with standard base \$5.00



C-11—1.1 Volt .25 amp. Dry Battery Det. and Amplifier. Special base. \$5.00



C-299—3 Volts. .06 amp. Dry Battery Det. and Amp. \$5.00



C-301A—6 Volts 1/4 amp. Amplifier \$5.00

# The complete line of Cunningham RADIO TUBES

FOR EVERY TYPE OF RECEIVING SET

WHATEVER type of receiving set or circuit you are using—one or more of these five Cunningham receiving tubes will be ideal for obtaining maximum distance reception with perfect reproduction of both voice and music.

Three of the five tubes are designed to use dry batteries for filament lighting. C-299, the latest development in Radio Tubes, is compact in design and highly efficient in operation as a radio frequency amplifier, a detector and as an audio-frequency amplifier. When used for the latter purpose, the output of two stages is sufficient for the operation of a small loud speaker.

The most remarkable feature of this tube is the new patented filament used which draws only .06 amperes at 3 volts.

C-11 is a dry battery tube with a special base for use in sets having special sockets. It is a good detector and audio-frequency amplifier. The filament is lighted from a single dry battery and draws .25 amperes. C-12 is identical to C-11 in operating

characteristics, but is mounted on a standard base to permit the use of a dry battery tube in sets equipped with standard sockets without the aid of special adaptors. Whenever storage battery supply is available for filament lighting, the C-300 will be the best tube to use as a detector because it is the most sensitive for the reception of distant and weak signals.

Under the same condition, C-301A will be the best tube for amplification at either radio or audio frequency, because it gives greater gain per stage than any other tube on the amateur market. The new patented filament used, similar to that in C-299 draws only .25 amperes at 6 volts, reducing the necessity of frequent storage battery charging.

**Patent Notices** Cunningham tubes are covered by patents dated 2-18-08 and others issued and pending. Licensed for amateur, experimental and entertainment use in radio communication. Any other use will be an infringement.

The care and operation of each model of Receiving Tube is fully explained in our new 40-page "Radio Tube Data Book." Copies may be obtained by sending ten cents to our San Francisco office.

*E. J. Cunningham Inc.*

Home Office: 182 Second St. San Francisco, Calif.

154 West Lake Street Chicago, Illinois

30 Church Street, New York City, N. Y.

★ Tested and approved by RADIO BROADCAST ★

DEC 8 1924

175  
Digitized by *Internet*®  
Bound  
Periodical

# RADIO BROADCAST

VOLUME V

*MAY, 1924, to OCTOBER, 1924*

BETTER RADIO



GARDEN CITY      NEW YORK  
DOUBLEDAY, PAGE & COMPANY  
1924

*Copyright, 1924, by*  
DOUBLEDAY, PAGE & COMPANY

# Here — the new Radiolas!

*New Triumphs of Radio Invention—  
New Performance Records*

"There's a Radiola for every purse"

\$35 to \$425

	† Model	Price	Approximate Range	Type of Antenna	Degree of Selectivity
	<b>Radiola III</b> With two WD-11 Radiotrons* and head telephones.	\$35	Jp to 1500 miles with headphones. Local stations on Loudspeaker.	Outdoor or indoor antenna.	Improved selectivity. Minimum radiating.
	<b>Radiola Balanced Amplifier</b> To be used with Radiola III. With two WD-11 Radiotrons.*	\$30	Gives Loudspeaker operation with Radiola III up to 1500 miles under favorable conditions.	Outdoor or indoor antenna.	
	<b>Radiola III-A</b> with four WD-11 Radiotrons,* head telephones and Radiola Loudspeaker. ..... Same without Loudspeaker.	\$100	Loudspeaker operation up to 1500 miles under favorable conditions.	Outdoor or indoor antenna.	Improved selectivity. Minimum radiating.
		\$65			
	<b>Radiola Regenoflex</b> with four WD-11 Radiotrons,* and Radiola Loudspeaker. ..... Same without Radiotrons or Loudspeaker.	\$206	Loudspeaker operation up to 2000 miles under favorable conditions.	Outdoor or indoor antenna.	Extraordinary selectivity. Non-radiating.
		\$150			
	<b>Radiola X</b> with four WD-11 Radiotrons.* Loud speaker built-in.	\$245	Loudspeaker operation up to 2000 miles under favorable conditions.	Outdoor or indoor antenna.	Extraordinary selectivity. Non radiating.
	<b>Radiola Super-Heterodyne</b> with six UV-199 Radiotrons* and Radiola Loudspeaker. ..... Same without Radiotrons or Loudspeaker.	\$286	Loudspeaker operation up to 2000 miles with internal loop. With external loop up to 3000 miles under favorable conditions.	No antenna. (Concealed small loop built into set.)	Super-selectivity. Non-radiating.
		\$220			
	<b>Radiola Super-VIII</b> with six UV-199 Radiotrons.* Loudspeaker built-in.	\$425	Loudspeaker operation up to 3000 miles under favorable conditions.	No antenna. (Concealed large loop built into set.)	Super-selectivity. Non radiating.

† All Radiolas sold without batteries.

\* Only dry batteries used.



Radio Corporation of America  
Sales Offices: 233 Broadway, New York

10 So. La Salle St., Chicago, Ill. 433 California St., San Francisco, Cal.

# Radiola

REG. U. S. PAT OFF

Send this coupon for an illustrated booklet that tells the story, completely, with detailed description of every set.

RADIO CORP. OF AMERICA  
Dept. 35. [Address office nearest you]  
Please send me your new free Radio Booklet.

Name \_\_\_\_\_

Street \_\_\_\_\_

City \_\_\_\_\_ State \_\_\_\_\_

★ Tested and approved by RADIO BROADCAST ★



IN LONDON

Operators from 2LO of the British Broadcasting Company, on the roof of a convenient building, picking up the Westminster Chimes and the musical boom of "Big Ben" atop the Houses of Parliament. The microphone is suspended in sponge rubber and is connected by land wire to the station three quarters of a mile away

# RADIO BROADCAST

Vol. 5, No. 1



May, 1924

## Home Remedies for Indisposed Receivers

The Simplicity of Good Grounds and Good Antennas. Getting the Bought Set into Action. Where Trouble May Lie and How to Eliminate It

By WILLIAM H. CARY, Jr.

This is the natural sequel to last month's article, "How to Go About Buying a Set." It is written primarily for those who know little or nothing about radio, but who have acquired sets from which they expect good results. Unless you are familiar with the installation and care of broadcast receivers, and unless you know how to diagnose and remedy certain simple ills that beset practically every radio set at one time or another, you are likely to think broadcast receiving a very confused and unsatisfactory hobby, indeed.

We are continually coming in touch with people who are balked by elementary details—who could increase the effectiveness of their receivers 100 per cent. by proper installation and adjustment of them; and perhaps more often still we find people who are prevented, by difficulties existing only in their own imaginations, from getting the best service from their newly acquired sets. This article is not a theoretical discussion: it is based on actual "cases," and on cures which are known to work.—THE EDITOR.

IT WOULD give an impression of pessimism which it is not the writer's intention to create, were he to plunge directly into the subject of treating sick sets, after discussing last month the purchase of brand-new apparatus. Still, new babies need careful treatment if they are to be kept in health; the fact that they are new does not make them immune to a number of elementary indispositions. The missing link in the chain of events from the purchase of a broadcast receiver and accessories, to apply first-aid remedies, is, of course, the assembly of the apparatus and its proper manipulation to get many a distant station and many a quiet evening (yes, it's possible) at home.

You were reminded last month that a thorough study of the instructions issued by the manufacturers of most sets, and the active help of some acquaintance who is familiar with receivers, will help greatly in starting you happily on your way. It is a pity that neither booklets nor acquaintances, however, always disclose the things you most want to know, in terms that resemble plain English.

### GOOD AND BAD GROUNDS

A CASE in point is the installation of the antenna and the "ground." Every broadcast listener knows that a wire attached to the ground post on the set "goes" to the water-pipe or radiator (or any conductor which



has connection with the earth). The trouble is, too many wires "go" and too few get there—completely. A space of one thousandth of an inch may separate the conducting part of the wire from the conducting part of the pipe or "ground" to which it is attached. And electrically speaking, one thousandth of an inch may be as unbridgeable as the Grand Canyon.

The other day, a man installed a new set for himself which did not work. He thought the clerk in the store must have given him bad tubes or batteries, and his maledictions fell upon his silent and shiny cabinet. But it was found that he had not scraped clean the surface of the waterpipe nor the wire which he had attached to it; and when one of his friends gently pulled the wire, its several turns unwrapped themselves, and the wire came off in his hands! Here is what the man should have done:

Scraped both wire and pipe, and

1—Soldered the wire to the pipe; or

2—Connected the wire to the pipe firmly with a ground clamp (costing about ten cents at any radio store); or

3—At least wrapped four or five turns of cleaned wire round the pipe, drawn it up tight by twisting with a pair of pliers, and bound up the connection with "electrician's tape" or adhesive plaster.

This is all the broadcast listener need know about grounds, except that the conducting path from set to earth should be as short as it can conveniently be made, and it is best not to use wire smaller than No. 14.

TWO WAYS OF FOR-  
GETTING ABOUT YOUR  
ANTENNA

IT IS also common knowledge that an antenna installation consists of a conducting material (wire) insulated from the ground and leading in to the proper binding post on the set. The fol-

lowing procedure in putting up an antenna is simple and adequate: through one hole in one of your small insulators tie a piece of rope (or cord or wire) and fasten one end of your antenna wire securely through the other hole. Attach the rope end anywhere, so long as it will allow from 50-125 feet of the antenna wire to swing clear (as high as possible above the roof or the earth) when the wire is run through a second insulator—likewise firmly suspended from any convenient object—and down into the room where you have your set. A lightning arrestor, useful principally to save your insurance should your house be struck by lightning (though a radio installation does *not* make this more likely), generally consists of a fuse with two binding posts on it. The antenna lead-in wire goes to one binding post, on its way to the set, and the ground lead goes to the other post, on its way to the set ["Where does this road go?" inquired the stranger. "Doesn't go, it stays right here," said the native." Yes, we stand corrected; but the figure of speech is convenient and clear.] Some types of arrestors require a slight variation from the above hookup. Instructions regarding the installation of lightning arresters are usually included with them.

LET'S THINK ABOUT  
THESE MATTERS

A PORCELAIN tube insulator inserted in a hole drilled through a corner of the window frame is the most-used method of keeping the antenna insulated at the point where it enters the house.

An antenna need not be erected out-of-doors. If you can run as much as forty feet of wire through several rooms and a hall, for instance, more or less in a

straight line, you are likely to get signals, although not so loud as with a higher and longer antenna.

It is by no means necessary to have a

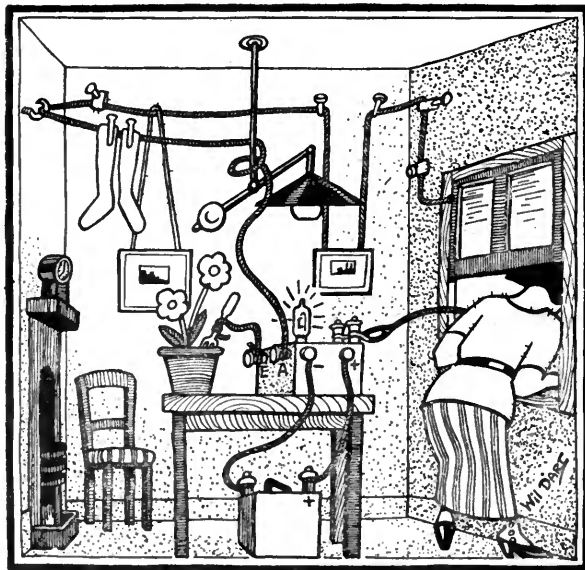

TOO MANY GROUND WIRES "GO" AND  
TOO FEW GET THERE—COMPLETELY



separate lead-in wire attached to the main part of the antenna. In fact, this requires an extra connection—one more place that may cause electrical loss. If you must have a separate piece of lead-in wire—if someone has persuaded you that a length of heavy, insulated copper wire is the “without which not” of successful reception, do not make the mistake of the following “case” (He happened to be, or just naturally was—however you may look at it—the same novice who made the easy-come, easy-go ground connection, referred to above):

Everything seemed to be O. K. Signals were audible, in fact; but they faded entirely at times, and at other times were suspiciously faint.

“I suppose your antenna system is all right,” said the friend who was still trying to locate the trouble, after having fixed the ground connection.

“Oh, yes—good antenna. It must be the bat—”

“Let’s take a look at the antenna.”

And so they did.

Up went the window and out went two heads. One head saw nothing particular to write home about, but the other saw this: the upper end of the lead-in wire sliding gently back and forth along the corroded surface of the antenna, in the wind! It is to the friend’s credit that he restrained his mirth and broke the news with enviable courtesy to the perpetrator of the installation.

What should the owner of the set have done in the first place? He should have:

1—Used only one piece of wire for both antenna and lead-in; or

2—Soldered the lead-in to the antenna; or

3—At least, scraped two inches of the antenna wire and two inches of the end of the lead-in, twisted them tightly together (not merely wrapped the lead-in about the antenna)

and bound up the wound with friction tape to prevent infection.

The same care should be used in joining any wires, without solder, in a radio circuit. Many

and pathetic are the ways in which beginners—and sometimes others connect wires together. The writer has seen one loop of wire encircling another loosely, taped, and called a joint. The idea seemed to be merely to hold the two wires from pulling apart, not to provide a free path for the flow of electric current. The commonest case of poor splicing is that of one wire twisted round another wire which is left straight. Oh, it works—sometimes.

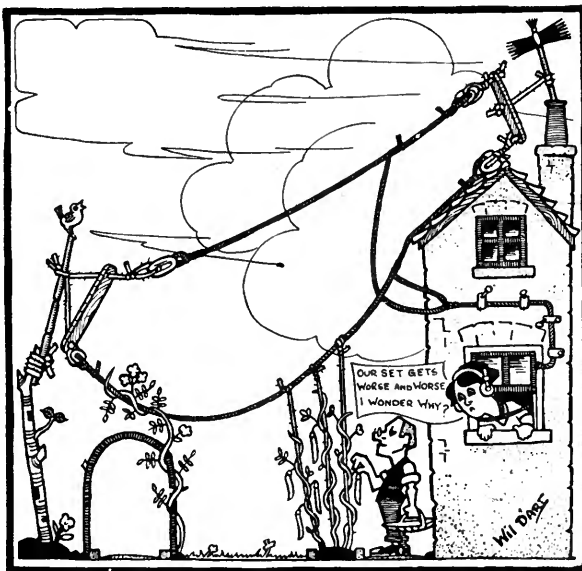

AND SO THEY LOOKED AT THE ANTENNA

One advantage of installing your ground and antenna in the careful manner described is that when something “goes wrong” with your set, you do not have to run up on the roof to look over the antenna, or get down on your knees by the water—or radiator—pipe to examine the “ground.” You can dismiss these factors from your mind. And it is just as well, for there may be other things to think of.

#### NOW ABOUT THE BATTERIES

ONE of the most useful instruments in any radio first-aid kit is a B battery voltmeter. It ranks next in importance to pliers, jack-knife, and screw-driver. Good voltmeters reading from 0 to 50 volts, may be had for about \$2.50. When a 22½-volt B battery falls below about 15 volts, you had better replace it. Sometimes, you will get no “kick” out of a B battery at all, or it will move the voltmeter needle only slightly. It has died in service and there is no use keeping it. Often, when a B battery is low or dead, an indication of its condition is seen in a damp spot on the side, where the electrolyte has leaked through, or by a bulging of the insulating compound on top of the battery. Your detector B battery voltage should be at least 16 and generally

cannot be allowed to fall far below 20. If the B battery voltage supplied to the amplifier tubes should fall below 40, it is well to add more "juice" or replace the low units with new ones.

Your A battery—whether it be dry cells or storage battery—is serviceable until you find that even when you turn the lights up as far as the rheostats will allow, the signal is not so loud as you have a right to expect. It is a good rule to burn your tube filaments as low as you can, still getting sufficient volume; it saves your batteries and reduces distortion.

It is advisable to hook up your batteries in this way: (1)—connect the two wires from the A battery to the + and - A posts on the set; (2)—connect either the + or the - wire from the B battery to its proper post on the set; (3)—place the tubes in their sockets, turn up the rheostats (also snap on the battery switch if there is one), and see if the tubes light: (4a) if so, connect the other B battery lead and all will be well: (4b) if not, look over the wiring and see that all connections are correct and good (If the tubes do not seem to make firm contact in their sockets, take the tubes out, bend up the socket prongs with your finger.) This procedure may save you the price of the tubes you are unlucky enough to leave in their sockets when the B battery current runs along the path reserved for the A battery.

AS FOR THE REST OF IT. . .

AS FOR the business of tuning, there is little that can be said which will be of half so much use to the novice as two or three evenings' practice in adjusting his set. He will soon get the "feel" of it, and learn how to cut out as much interference, static, and other

noise as is possible, without diminishing the signal strength too much.

If you are using two or more tubes of the same type, try interchanging them and then readjusting the rheostats and other controls. This often results in a considerable increase in signal strength.

When a set goes dead, with antenna and ground connections as they should be, with batteries well up, and tubes hitting on all four, trouble may possibly be located in the jacks, or in the phones, or in a broken connection elsewhere in the set. The jack springs should be inspected: does the tip of the plug make contact with the proper spring? does the side of the plug fit snugly against the side of the jack? do the springs which are displaced by the tip of the plug make (or break) their contacts as they should?



The test for phones is simple: put them on; touch the tip of the plug (or one phone tip) to one terminal of a dry cell, and touch the sleeve of the plug (or the other phone tip) to the other terminal: a click should result. "No clickee, no workee."

If you have done all this, and have looked in vain for a loose or broken connection, it is then time to secure the assistance of someone familiar with the more serious ailments of receiving sets. But the chances are that this will not be necessary. If you had trouble at first, and started reading this article, you will probably have located your trouble and applied the remedy a page or so ago. Instead of reading these words you will have abandoned them for the serious business of bringing the programs that float so freely through this country's air.

## A Plea to Announcers

Many letters have come to RADIO BROADCAST and many more have been received by broadcasting stations complaining that station announcers announced too indistinctly or too infrequently. This card was recently sent out by the National Association of Broadcasters to all their member stations.—THE EDITOR.

### STATION ANNOUNCERS

Numerous complaints have recently come to us of announcers failing to give their call letters at the end of each program event. D.X. fans are especially aggravated.

Local listeners know your station, but hundreds of thousands of long distance listeners on the air each night, do not.

Call letters given immediately after an event and repeated again at the conclusion of announcement are appreciated by these people.

THE NATIONAL ASSOCIATION OF BROADCASTERS  
1265 BROADWAY, NEW YORK CITY

# Reflexing Your Single Circuit Receiver

## Various Circuits and What They Mean

### PART VI

By ZEH BOUCK

There are only a few of our readers to whom RADIO BROADCAST has preached, in vain, the evils of regenerative single circuit tuners. But many owners of single circuit apparatus protest against junking equipment in which they have invested, perhaps, hundreds of dollars. —There is a certain justness in their point of view. However, there is no necessity for relegating the single circuit regenerator to the ash-can. They can be made over, at a very small expense, and with an increase in efficiency into the “Knock-out” reflex circuit that has taken our readers by storm.

Mr. Bouck tells how to do it.—THE EDITOR.

MUCH has been said and written condemning the single circuit regenerative receiver. So vehement has been the reaction against *radiating* (not *reradiating*) receivers, which, like the spark transmitter, has lived its day that was genuinely useful, that there are a very few, even among the manufacturers, who fail to appreciate and proclaim the iniquity of such oscillators. But regardless of the universal appreciation of the several faults of single circuit tuners and the sincere desire to remedy them, the propaganda against them has been mostly destructive, except for advocating a complete change in receiving equipment. The manufacturers have quite profitably backed this advice by placing on the market, at the psychological moment, non-radiating equipment. But there are many of us who, urged by these same manufacturers only a few months back, invested our entire radio budget in the receivers that they now condemn, and who must necessarily hesitate before making the change that means so much to general and individual radio improvement.

While several substitutes have been suggested for the offending circuits—straight radio-frequency amplification, the neutro-

dyne, the super-regenerative and reflex sets—from the standpoint of economy, simplicity, and the loudness of signals, the three amiable characteristics of the defunct criminal, the one-tube reflex is the only substitute. It is more than a substitute—it is an improvement.

#### DO NOT THROW AWAY YOUR SINGLE CIRCUIT RECEIVER

TO ACQUIRE the advantages of the reflex receiver, it is neither necessary nor desirable to discard your present single circuit set. By altering a few connections within the receiver and building up a small external panel, all quite within the ability of our more timid experimenters, the most powerful single circuit oscillator can be converted into a reflex set that is a revelation in quality and intensity of signals.

Fig. 1 is a photograph of one of the most prevalent types of single circuit regenerators

transformed into the reflex. Figs. 2 and 3 are close-ups of the extra panel equipment that effects the conversion. For want of a better term, and because the same auxiliary arrangement may be applied to any single circuit receiver regardless of superficial circuit variations, the writer has named this little secondary panel the “reflexit.”

#### What You Need to Build the “Reflexit”

IF YOUR set is a single bulb receiver of the type described, the following additional items are necessary to avoid the blot of ostracism:

One crystal detector (preferably fixed).....	\$1.25
$\frac{1}{8}$ th pound No. 22 magnet wire .....	.35
One length 3 inch cardboard tubing.....	.15
One .00025 mfd. variable condenser (C2)..	3.00
One audio amplifying transformer (T3)....	4.00
One panel, 5" x 6".....	.50
Knob and dial.....	50
Incidentals.....	.25

Total \$10.00

## IS YOUR SET ONE OF THESE?

WE CHOSE for our original demonstration the single circuit tuner in most common use. The circuit is shown in Fig. 4, and many of the trade names under which this system parades are divulged in "The Truth About Trick Circuits," appearing in the March number of RADIO BROADCAST. In addition to the hundred of thousands of manufactured sets of this type, an incalculable number have been built at home by experimenters.

In the majority of cases, L<sub>1</sub> and L<sub>2</sub> are respectively primary and secondary of a variocoupler. In the cheaper equipment, L<sub>1</sub> is the stator of a variometer, and L<sub>2</sub> the rotating ball. The antenna series condenser (C<sub>1</sub>) is generally a .0005 mfd. (23 plate) variable. The doubtful reader will find the mechanical and electrical characteristics of this receiver more completely described in the March article

to which we previously referred. Single tube sets of this type sold—and, alas! still sell—for from eight to twenty-five dollars.

The indicated prices are conservative, and on some items the enthusiast will probably be able to better them. An ordinary cat-whisker crystal stand may, of course, be substituted for the fixed element. The latter, however, is superior in several ways. It insures the most sensitive detection without any adjustment, and, due to the low resistance between its terminals, eliminates the possibility of oscillation and squeals.

Fig. 5 is the complete wiring diagram—the rewired single circuit receiver (left) connected to the "Reflexit" (right). Our observing readers will note that the circuit is identical with that of our "Knock-out" reflex, and it differs only mechanically in the substitution of the variocoupler (T<sub>1</sub>) for the usual fixed coupler. In re-wiring the single circuit tuner, the

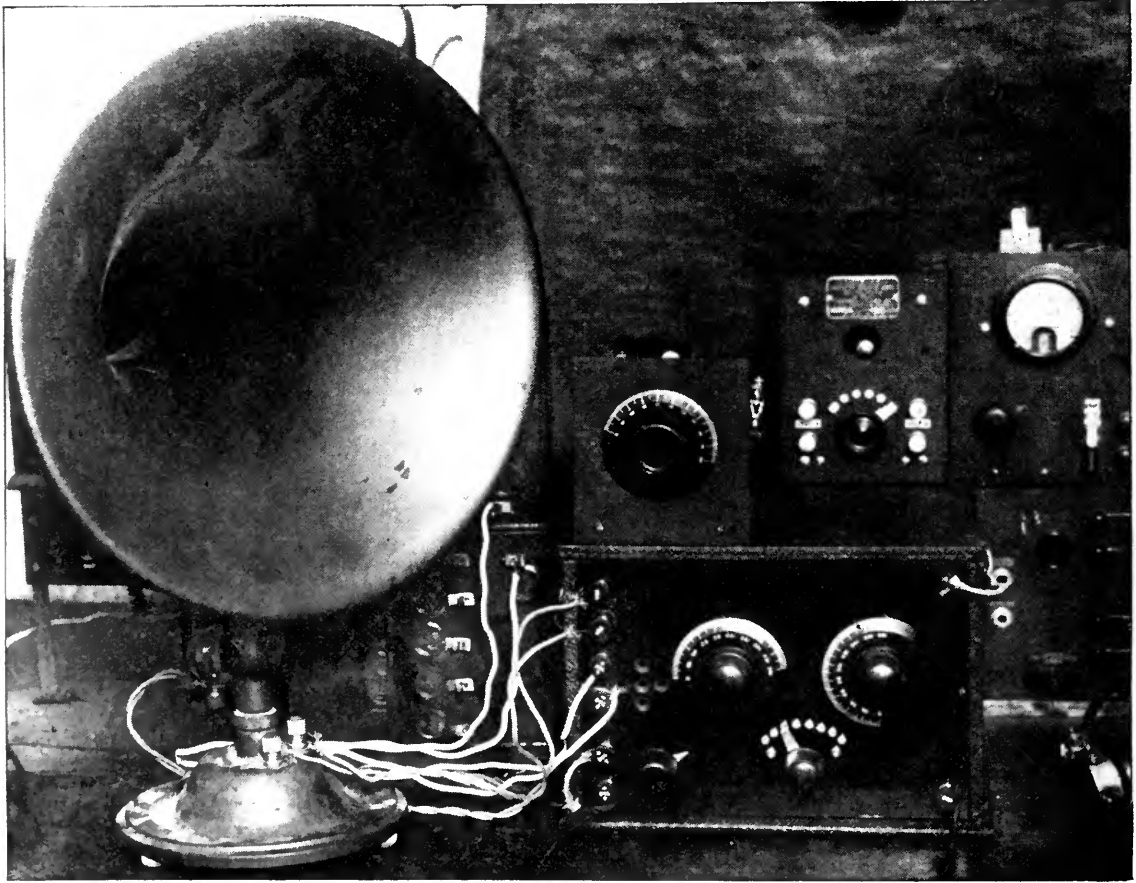

FIG. 1

The "Reflexit" connected to a very common type of single circuit, radiating regenerator

only connection that may remain intact is the lead from the ground to the primary of the variocoupler and to the filament.

#### CONSTRUCTION

**I**NDUCTANCE T<sub>2</sub> is wound on a 2½ inch length of the 3 inch tubing. The secondary is wound first, and consists of 51 turns. A layer of pasteboard is placed over the winding, and the primary of 31 turns wound on this.

T<sub>3</sub> is any good audio frequency amplifying transformer with a ratio of from four to six to one. The Amertran was used by the writer.

The method of mounting and placing of the various parts in the "Reflexit" are clearly shown in the photographs of Figs. 2 and 3. The "Reflexit" may be set and operated in any convenient position near the receiver proper. The writer found it best disposed of by permanently mounting it on the cover of the original

cabinet by a wood-screw through the base. Four wires, indicated by the dotted lines in Fig. 5, run through the base and cover, and connect the "Reflexit" to the rewired single circuit tuner. In the combination photographed, the four leads are of flexible lamp cord, sufficiently long to permit the raising of the cabinet cover.

They are brought down through *two* holes, the leads from T<sub>2</sub> and T<sub>3</sub> being purposely separated to obviate the possibility of feedback from plate to grid circuits.

Where the original single circuit receiver has been built with a generous distribution of free panel space, the experimenter may find room for the extra control, making it possible to incorporate the "Reflexit" entirely within the old receiver. The Ballantine Variocoupler adapts itself very nicely to this more compact arrangement, and a circular space, less than two inches in diameter is sufficient for mounting it.

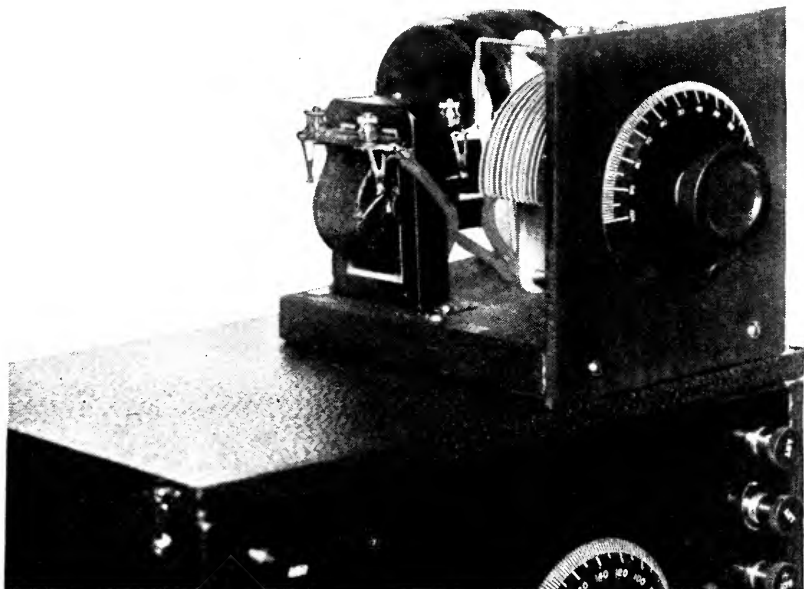

FIG. 2

A close-up of the "Reflexit." The leads to the re-wired single circuit receiver run through the base and cover

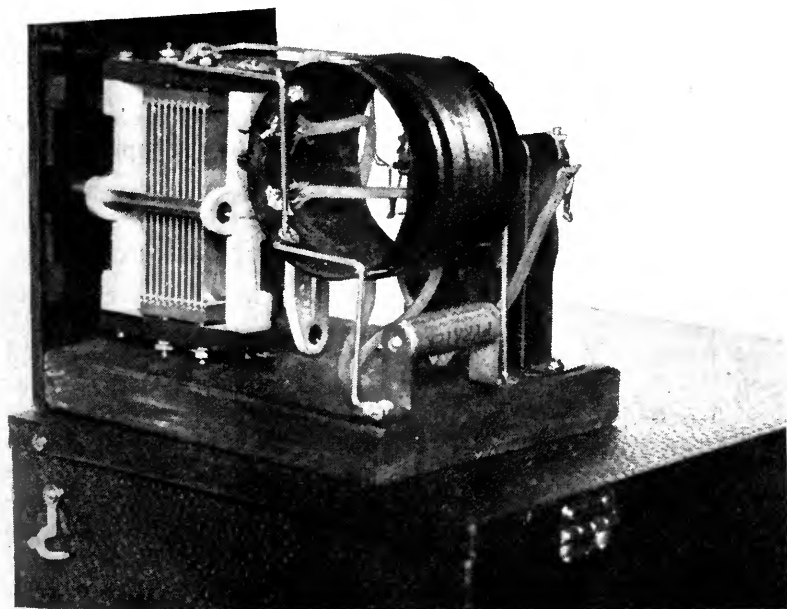

FIG. 3

Another view showing the "works." Note the fixed crystal, a "Pyratek" which works well

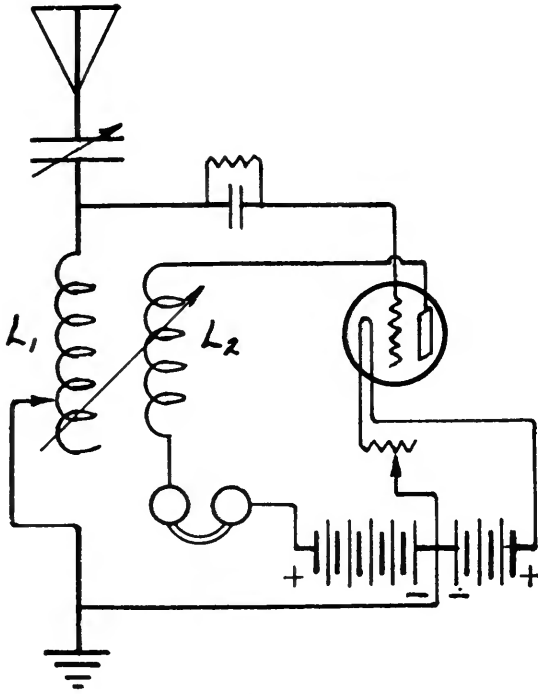

FIG. 4

The most common type of the single circuit receivers

When the Variometer is used, it is connected in place of  $T_2$ —the plate connection running to the plate of the tube—and condenser  $C_2$  is eliminated. The connections from the secondary of the Variometer to the crystal and  $T_3$ , may be effected without regard to lettering or electrical direction. (If a mistake is made, it is compensated for by reversing the cartridge detector in its clip. This experiment should always be made in order to secure the correct directional flow of the rectified current. A difference in signal strength with reversed flow may be noticeable only on weak signals; the test should therefore be made on distant stations.)

The reader is referred to the Laboratory Department of the January RADIO BROADCAST for additional data on the use of Mr. Ballantine's tuned radio frequency amplifying transformer in the one-tube reflex circuit.

If the reader doesn't care to thread-wind the inductances himself there are several manufactured coils such as the Workrite, Fada, Anso, and similar transformers designed for use with the neutrodyne receivers which may be employed. When substituting these commercial inductances for  $T_1$ , it may be neces-

sary to remove a few turns of wire from the primary, reconciling the completed coil to the specifications we have given.

#### THE SINGLE CIRCUIT TUNER WITH A TWO STEP

**I**F YOUR present receiver is a single circuit tuner of the type described, plus two stages of audio amplification, it can be reflexed with similar ease, and with less expense by using the last audio transformer as  $T_3$ . A second stage of amplification is seldom necessary with the one-tube reflex, nor, due to complications, is it desirable. The single tube alone will operate a loud speaker satisfactorily on local stations, while one extra audio stage gives "dancing intensity." Using one step of audio

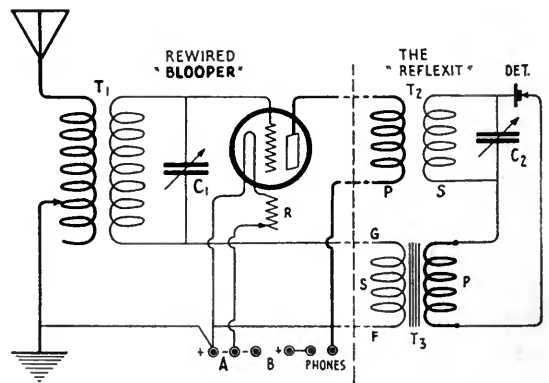

FIG. 5

How to connect the "Reflexit" to the re-wired single circuit receiver. The dotted lines indicate the flexible leads between the two units

amplification, the output or 'phone leads from the reflex are connected to the input—either to jack or primary of the transformer—of the first stage.

#### OTHER SINGLE CIRCUIT RECEIVERS

**A**NY single circuit set may be converted into a reflex by the addition of the "Reflexit." In the case of slight electrical or mechanical variations from the circuit described, such as in the "Aeriola Senior," the method of adapting the "Reflexit" will immediately suggest itself to our more experienced readers. However, our less sophisticated enthusiasts, interested in the further possibilities of this device will find them covered "In The R. B. Lab" of coming issues. There will be described, each month until the subject is exhausted, the manner of adapting the "Reflexit" to the less familiar forms of radiating receivers.



REBECCA HAIGHT

'Cellist of the Cleveland Institute of Music String Quartet

# The Listeners' Point of View

Conducted by  
Jennie Irene Mix

## How Shall We Get Great Artists to Broadcast?

**W**HEN and how this much discussed question of paying the artists who are heard over the radio will be settled to the satisfaction alike of the artists, the public and the broadcast stations, it would be futile to forecast. Thus far the published discussions of the subject have conveyed three outstanding impressions. First, that the public should be given frequent opportunity to hear, through the radio, the most

famous singers and instrumentalists. Second, that all concert artists feel that their profession brings them such steady and lucrative returns that the radio can be of no benefit to them other than the compensation received for broadcasting. Third, that this compensation should be the same as that which they receive when appearing on a concert stage.

Now for the first point. With the exception of New York, and possibly also Chicago, there is no city or town in the country that has an



average of one concert a week by an artist of international fame.

The accentuation in this country of the fame of an artist, depending chiefly on this for his drawing power, has done much to retard the growth of discriminating musical appreciation by deflecting the interest of the public from music to the musician. It has also been the means of withholding deserved success from many who, for one reason or another, have not been able to achieve this spectacular fame.

The desire of the directors of broadcasting that the whole country be given opportunity, through the radio, to hear the great singers and instrumentalists is deserving of all admiration. Their mistake lies in thinking that concerts of this character should be given once a week and more often if possible. In truth, if these de luxe programs were given once a month it would mean a marked increase in such opportunities as compared with conditions that have prevailed in the past and still prevail.

We come to the second point which is the most vital of the three. Let us begin the answer to this by a question.

Of what benefit is it to a concert artist to be heard by radio?

The benefit is so great and so many-sided that it cannot be measured to the full. Yet, because every man is worthy of his hire, every artist who is asked to contribute to a radio program should be paid for his services. Any other arrangement, when it is a custom, makes for the lowering of the relationship between the artist and those who ask him to give his

services for nothing. The concert-giver's art is as much a commercial commodity as are any of the necessities or luxuries which we daily purchase for the support or embellishment of our bodies or our surroundings. With the exception of performances given for charitable purposes, there is no more reason why the musician should be asked to provide entertainment gratis than why any of us should ask the grocers to feed and the clothiers to clothe us free of charge.

But, on the other hand, those of us who have been much behind the scenes of the concert world do not take seriously the assertion that the artist, no matter how great he may be, is not benefited by being heard by radio audiences.

The concert artist lives on public patronage, and public patronage can be obtained only through advertising. This advertising is carried on through two mediums. The straight out-and-out advertising which appears in newspapers and musical magazines, and the veiled medium in the form

of stories which the publicity agent concocts and then persuades editors the public will eagerly devour. Both of these mediums cost an incredible amount of money. The reason why so many fine artists have passed into the obscurity of the teaching profession is because they have not had the money to keep up this advertising. Their names must be constantly before the public if they are to succeed.

And even after success has come, the advertising must be kept up with equal vigor, or they drop to the rear of the procession, then soon are out entirely.

We grant that every rule has its exceptions. There are at present two artists in the concert field—a man and a woman—who, such is their immense popularity, never have to do any general advertising other than that which gives notice of a coming concert. Who are

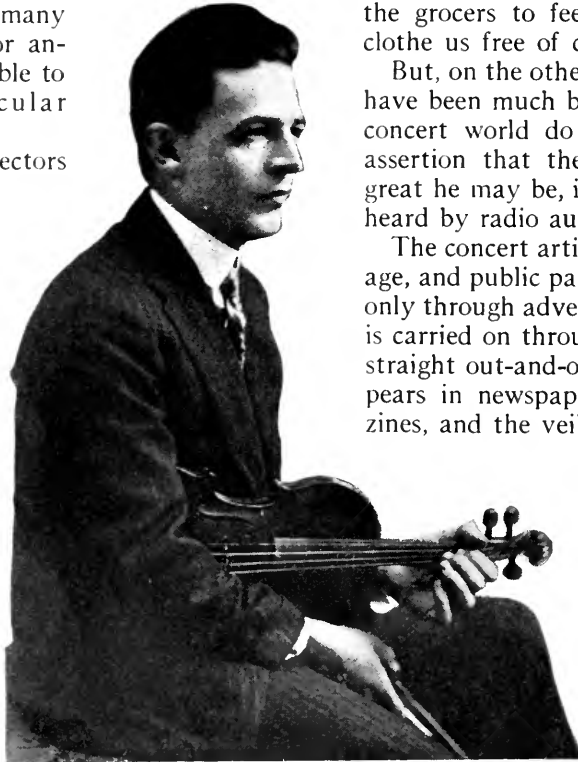

ALBERT SPALDING

American Violinist. Mr. Spalding, whose fame has become established far beyond the confines of his own country, is frequently called, "The aristocrat of the violin," for the reason that his playing is always characterized by such classic poise and beauty that place him in a class by himself. When he recently played with the New York Philharmonic orchestra, the concert was broadcast and many from distant stations later sent word that they had heard Mr. Spalding as clearly as if they were in the hall. He is under the management of the Wolfsohn Musical Bureau

they? It should be necessary only to say that one is a violinist, the other an erstwhile prima donna. But, mark you, in past years they spent large sums for all kinds of publicity.

If he is not advertised the artist has no chance to be heard. And many, even if advertised, still have little or no chance. It is not uncommon for thousands of dollars (the artist's dollars) to be spent in attempts to get him before the public, but without success. The workings of the concert world behind the scenes are so intricate, so many factors enter into the success or the failure of every booking even of the long-established artists, that for those less known the profession brings but a hand-to-mouth existence.

To such as these the radio should prove of incalculable value. Through its means they can be heard not only by the general public,

#### MORIZ ROSENTHAL

—Polish Pianist. For more than forty years Moriz Rosenthal has been a dominating figure in the musical world. He first toured this country when he was little more than a youth. His second tour was in 1896-7. And now, at the age of sixty-two, and after an absence of seventeen years, he is again being heard here. His initial New York recital, given soon after he arrived, was broadcast through the cooperation of the Radio Corporation of America, and reports received from his managers, the Wolfsohn Musical Bureau, tell of gratifying results



ALPHONSE GUYON

A young pianist whose recitals have a number of times been broadcast by the Westinghouse Station, WBZ, at Springfield, Mass. Mr. Guyon's work will bear watching by those who are looking for fresh talent admirably trained. His programs are always of high standard, and his playing, especially of works from the romantic school, intelligent and imaginative

but, what is even more important, by concert managers throughout the country.

The day has gone by when concert managers engage artists on the excerpts of criticisms of the artist's appearance in New York City. This, because such excerpts are only from the laudatory portions of the criticisms, and because too many times has it happened that the singer or player has failed to measure up to the exacting standards obtaining in what the effete East so condescendingly refers to as "the provinces." In the past, managers have lost so much money in promoting musical attractions on New York prestige, or what seems to be such from the critical excerpts, that they have grown wary. They must hear to believe. Not being able to hear, they strike the artist's name from their contemplated list of attractions.

But suppose they could listen in to these



New York concerts, or could hear the artists sing or play a group on a regular radio program. This would go a long way toward solving the problem for the artist and the manager. Music, to be sure, does not always broadcast sufficiently well to give the hearer a just basis from which to judge the performer. But it does so often enough to make this means of communication between the artist and the manager worth the trying. There are certain fundamental qualities that every artist must reveal, and when the numbers broadcast are well known to the listener these qualities can in many instances be discerned. The tempo carries with fidelity; the phrasing can be followed; also the proportion with which the entire number is made a well balanced whole. And, miracle of miracles! the radio brings out with amazing effect the feeling with which a work is interpreted. The performance of a number over the radio that is characterized by consistent *tempi*, intelligent phrasing, the adjustment of each part so that it makes a well proportioned whole, and an understanding of the emotional content, brings assurance that the singer or player has the qualities of an artist.

Why then, if he can get into touch with concert managers through the radio, should such an artist be paid for his performance?

For the simple reason that even while he is benefiting himself he is giving pleasure to untold numbers of listeners and thereby helping to make this particular program a desirable one.

So all-powerful is this matter of publicity in the musical world that it would be well for artists and their managers if every worth-while program given in New York were broadcast. The mechanical devices that have made possible the hearing of artists through their records, are what has made the success of these artists when touring the country. This has been proved beyond all question. The artist who has never made records cannot com-

pete with those who have. This fact destroys the argument that if people hear an artist over the radio they will not trouble to go and hear him in concert. They will not only want to hear him in concert when the opportunity presents itself, but they will go the most readily to the program that contains some of the numbers they have heard by radio.

Perhaps, at first, some people will stay at home and listen in if, when the artist comes to town, his program is broadcast. But, ultimately, unless human nature changes in the meantime, the broadcasting of programs of an artist on tour will have little if any effect on the attendance at concerts. There was the same panic among the mana-

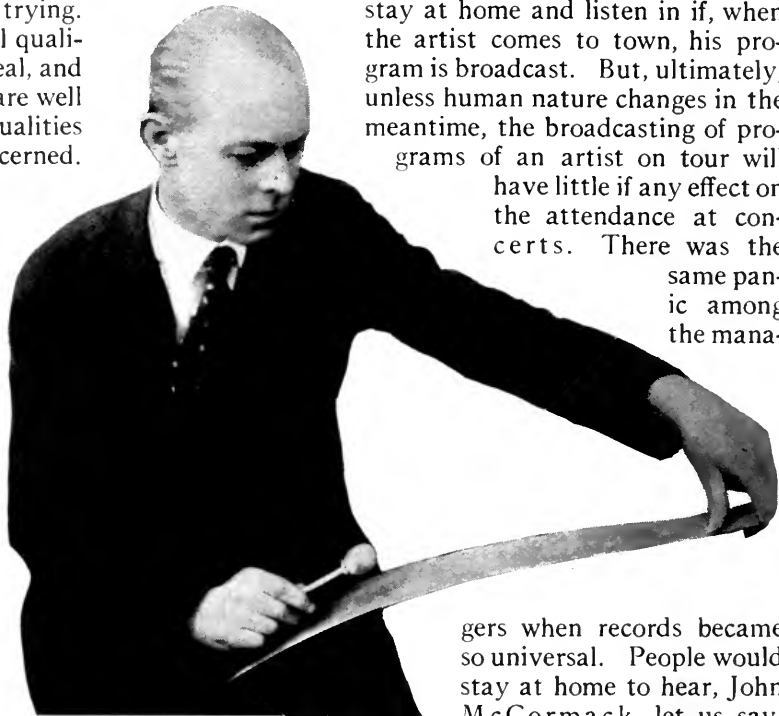

WILLIAM MENZER

At work with his musical saw. On several occasions the peculiar harmony from this remarkable instrument has been broadcast from WJZ, New York

gers when records became so universal. People would stay at home to hear, John McCormack, let us say, through his Victrola records, rather than paying to hear the same numbers in the concert hall. But they did nothing of the kind. On

the contrary it was because they had his records that they went to hear him. They wanted to be right there on the spot to look at him while he sang.

And now to the third and last point: The amount that should be paid the artist for broadcasting.

The general impression seems to be that the remuneration for a radio performance should be the same as that received on tour. The truth is that one-half of this remuneration should be sufficient to leave the artist as large if not a larger profit than he makes in his regular concert work. Much has been said about the big sums earned by concert artists. But note what has to be paid out by them.

The traveling expenses for the artist, and, unless he is a pianist, the accompanists' fee and also his traveling expenses with the exception of his hotel bills; the manager's commission; advertising and publicity; the practice hours with the accompanist preliminary to the tour; dress proper for every occasion, morning, afternoon, or evening concert, and always up to date and immaculate. The waits between engagements when the hotels make inroads on the fee. And the many small expenses that in the aggregate bring the fee down still more.

All of these expenses are taken into consideration when the artist's fee is fixed. But it is a question whether the same fee should be required for a radio performance which would entail no expense on the artist except his manager's perfectly justifiable commission and, when necessary, his own accompanist. This is a point to which broadcast directors would do well to give consideration.

As for the aspirants for concert careers who are still in the non-professional class, they should not be paid anything for broadcasting. These radio opportunities should be looked upon by them as débuts. If they go to New York to make a début (as hundreds of them do) it costs them, entirely aside from their personal expenses, anywhere from \$600 to \$1,000 for the one concert. Not a dollar comes in at the box office to help out, because the houses are always padded for these débuts. Why, then, should they expect to be paid if they make a début via radio? To be quite frank, the truth is they should not be heard at all through this medium until their work has been approved by a competent committee of judges.

Music in its relation to the radio is a problem that many directors of broadcasting are earnestly striving to solve. The right

solution can come only through a thorough knowledge of the musical conditions existing in the concert field as well as in the field of radio.

"Humoresque" and the "Suwanee River"

ONE of the most popular instrumental numbers with radio listeners is Dvorak's charming, "Humoresque." But perhaps few who hear it know that the theme is taken bodily from "Suwanee River." You can easily prove this by playing the "Humoresque" while at the same time singing the song. In the days when Alma Gluck and Efrem Zimbalist used to tour together one of their most popular encore numbers was the singing by Gluck of "Suwanee River" to the accompaniment of "Humoresque" played by Zimbalist on his violin. The combination was not, as many supposed, a discovery of theirs.



RUTH WILLIAN

Second violin of the Cleveland Institute of Music String Quartet

It has long been known to musicians. Dvorak, from 1892 to 1895, was director of the National Conservatory of Music in New York, and during that time became much interested in the melodic character of plantation music. He made use of these melodies in his "Symphony from the New World" although in mood the symphony bears the flavor of his native Bohemia, and is not, as some would have us believe, intended to be representative of America. And although he used "Suwanee River" as the theme of "Humoresque" this composition, too, is Bohemian in spirit.

If Dvorak were living and could get a royalty on every radio performance of "Suwanee-Humoresque" he would be a plutocrat—among composers.

#### When Singers Broadcast

**H**ERE'S a bit of advice for singers who broadcast.

Don't drag the tempo!

Contraltos in particular are apt to slow down the tempo until they get on the listener's nerves. They are inclined to do this on the concert stage, which is bad enough, but when it comes to the radio the habit becomes distressing. Nor are sopranos and tenors wholly exempt from this criticism, but for some reason the baritones nearly always keep the tempo up to normal.

When a singer drags through a phrase, it means a gasp for breath at the end of it. This gasp is even more apparent over the radio than in the concert hall.

The radiomicrophone is an extraordinarily faithful reproducer of every sound, a fact which artists may slight and it will be well for singers to remember this when broadcasting if they want to make a good impression on their listeners, which, of course, they all do.

**T**HE Wolfsohn Musical Bureau goes on record as one of the first organizations among the musical managers to broadcast not only the New York concerts given by their artists but also those presented on tour. At a time when musicians and managers are uncertain of the answer to the question "to broadcast or not to broadcast," this action is decidedly interesting.

To this management also goes the



CECILIA HANSEN

—Russian violinist. One of the artists under the management of the Wolfsohn Musical Bureau who broadcast from the Waldorf Hotel at the Massachusetts Institute of Technology alumni dinner on March 7, 1924. WJZ, WGY, KDKA, KFKX, KGO, and 2AC (Manchester) broadcast her playing. On the same program was Mario Chamlee, one of the leading tenors of the Metropolitan Opera Company. One estimate has it that an area of one million square miles was covered in this wholesale broadcasting experiment

credit of being the first to have a concert broadcast throughout the country by relaying it through four stations across the continent.

This was done when Mario Chamlee, one of the leading tenors of the Metropolitan Opera Company, and Cecilia Hansen, Russian violinist, recently gave a program at the Waldorf Astoria, New York. Through the coöperation of the Radio Corporation of America, Westinghouse and General Electric Companies, this concert was broadcast from Station WJZ, New York, picked up to be rebroadcast by WGY, Schenectady; KDKA, Pittsburgh; KFKX, Hastings, Nebraska; and at 10:30 P. M. New York time, station KGO at Oakland, California, and station 2AC of the Metropolitan-Vickers Company at Manchester, England. Various estimates of the amount of territory covered by this quite revolutionary "blanketing" broadcasting have been made, the most striking perhaps being that one million

square miles of the earth were reached. Among others under this management whose concerts have been heard by radio are Moriz Rosenthal, Albert Spalding, Manuel Quiroga, Mabel Garrison, and the New York String Quartet.

## As If From Heaven

ANY ONE who has not listened over the radio to the choir of St. Paul's Episcopal Church in Detroit should do so at the next opportunity that presents itself. Whoever is the organist there knows, as do few church organists, how to eliminate the usual deadly monotony of church singing. The numbers that should go with spirit go with such unflagging life that the only word by which to describe the effect is the hackneyed, "Inspiring."

Not long ago they sang, evidently as the recessionist, "Onward Christian Soldiers." It came through the ether like a thunderous yet bright clarion call to action.

They sang every verse. A group of us listened in silence, the effect being all the greater because the singers could not be seen. At the close, one in the group said, "But it didn't sound at all like church singing." To which a young man, not conspicuous for his interest in church matters, replied, in awed tone:

"No. It sounded like the Heavenly Host."

IT IS becoming quite the thing for radio stations to give occasional programs made up wholly of songs that were the popular songs of the day, thirty, forty, fifty or more years ago. WOW at Omaha, Nebraska, has presented

a number of such programs. A delightful custom and one that should continue. What reminiscences these songs must bring up to those who were young when they were the vogue. It would be a good thing if some of them could be permanently revived. There's romance in them and gayety as well—humor, too. No doubt, when broadcast, they set many a grandfather and grandmother telling of the good times they had when they were young.



ANDRE DE REBAUPIERRE  
First violin of the Cleveland Institute of Music String Quartet

ALTHOUGH, in age, this department is only in its second month, a number of inquiries from readers have been received along the line of Won't you please write something about this? or What do you think of that? and so on and so on.

Which leads to the statement that the conductor of this department will always be glad to receive opinions, whether critical or otherwise, of whatever may be said in the department;

also suggestions as to what ought to be said for the good of all concerned.

An editor's opinion, although drawn, as it always should be, from long and practical experience along the lines discussed, is yet but an individual opinion. And as we should all, no matter how firm our convictions on any subject, be ready to hear the other side, this department will ever be open to progressive criticisms or constructive ideas.



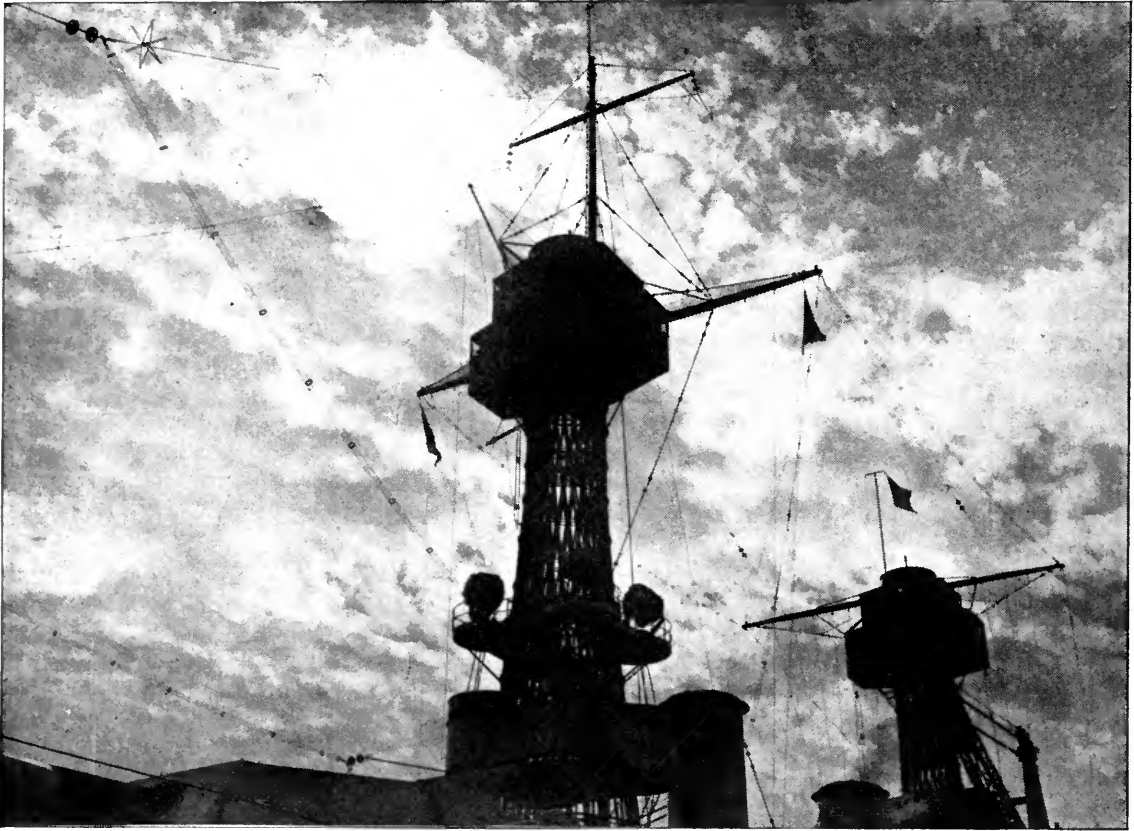

#### THE RADIO ANTENNAS ON A DREADNAUGHT

The illustration shows the antennas on the U. S. S. *Colorado*. The long cage antenna is used for the large arc transmitter. The other antennas are used for spark and radio telephone communication

## The March of Radio

### Is the Problem Solved?

**S**O MANY times we have asked the question—"Who is going to pay" that any reasonable attempt at the solution of the question of the cost of broadcasting is very welcome and will be watched by millions of listeners with a great deal of interest. In the very first issue of RADIO BROADCAST an attempt to analyze the possible solutions of this problem was made. One of the possibilities suggested then was that of soliciting contributions from the radio audience, a scheme the Church has depended upon heavily for many years. It is not at all evident however that the radio broadcast managers would be as successful in this method of getting funds as are the ministers of the

gospel; neither the hope of Heaven nor the fear of Hell will act as brother conspirator with the station manager to pry loose some of the savings of their audience. It seemed possible even two years ago, that the public would respond to an appeal for funds in an unexpected degree, and the possibility is even more imminent to-day after the remarkable demonstrations of the way in which radio broadcasting, properly supported, can instruct and amuse its millions of listeners.

With this idea in mind a committee of New York business men has been formed to try out this scheme of broadcast financing. It seems evident that a station itself could not very well carry out such a scheme because a large



part of the public would imagine that their contributions were going to pay dividends for the stockholders of the company rather than for putting out good programs. One or two rumors to this effect would kill completely any scheme managed and controlled by a business concern such as the Radio Corporation or the American Telephone and Telegraph Company.

To convince the public that a bona fide attempt was being made to give them self-supporting radio, the committee which has undertaken the task of introducing this innovation has been wisely made up of prominent financiers, who could not possibly be suspected of any idea of profit-taking, and who have been intimately connected with many other musical ventures. They are men whose names will at once command the respect and confidence of the prospective contributors. This committee has solicited funds from the radio public, calling for contributions of from a dollar up, from all those who are entertained by WEA, through which the new broadcasting programs are to be sent. This station has been selected, it is said, because of the "excellent quality of its modulation and transmission." All of the funds received from the radio listeners will be directly applied to the securing of artists of the highest caliber. The committee will serve voluntarily, and the station, WEA, has agreed to carry out the programs free of charge. This is no small contribution on the part of the American Telephone and Telegraph Company in view of the fact that this station commands a fee of \$400 per hour for its use for advertising.

There have been favorable comments made about the scheme, and some adverse and discouraging. The manager of a well known station expresses the opinion that the public will not contribute to any extent for a form of amusement which they have a fair chance of getting without paying for it. For he says the letters he has received from his listeners recently seem to show a spirit of dissatisfaction with what they are getting already, rather than a willingness to part with some of their good money to help the distraught manager in scheduling more interesting events.

The price paid for a good receiving set to-day is high, and any business man who looks inside his \$150 or \$200 set naturally wonders why he has to pay so much for a few coils, condensers, tube sockets and the like. Feeling that he actually got about \$50 worth of apparatus in

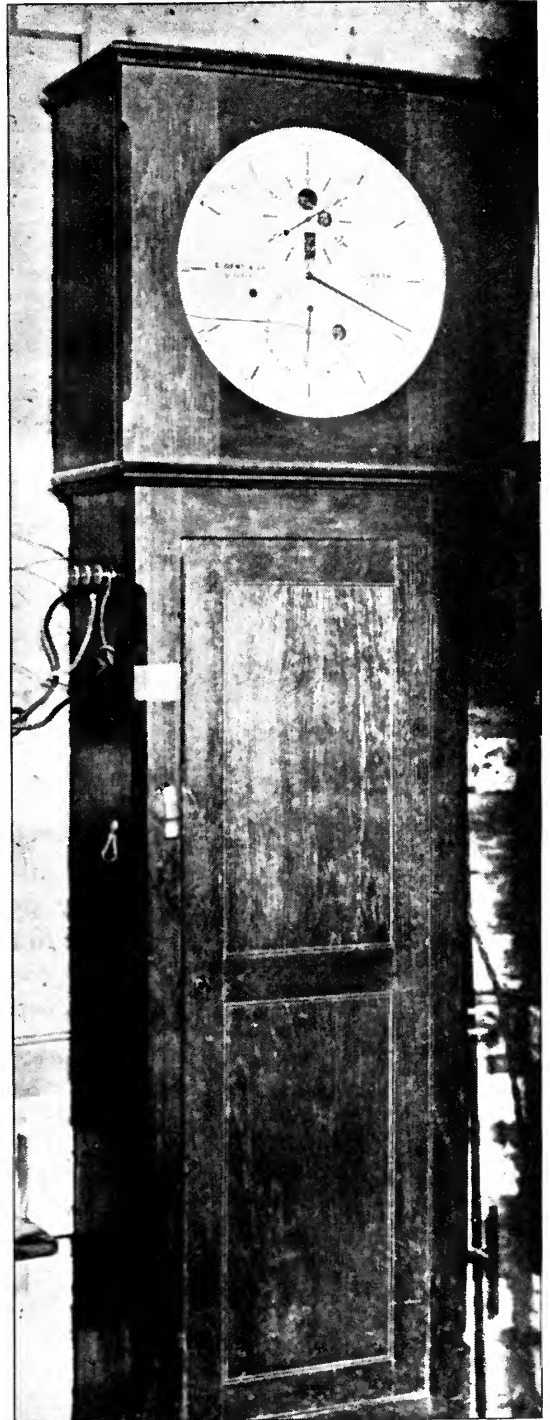

© Underwood & Underwood

#### THE MOST IMPORTANT CLOCK IN THE WORLD

Is this chronometer at the Royal Observatory, at Greenwich, England, the starting point of longitude in the world's maps. Signals from this clock are now sent out daily from all nine stations of the British Broadcasting Company

his purchase he expects to realize on the other \$100 from the enjoyment of radio programs for which he will not have to pay anything. Hence when these fail to please he unconsciously feels that he has, perhaps, been "done" and hence his letter of discontent to the station manager.

Another objection to this proposed scheme of broadcast financing naturally comes from those stations which will not secure the service of these well paid artists. "It looks all right for WEAF," says one manager, "but how about the other 534 stations in the United States?" This bares a very important point in the broadcasting situation: are all these stations entitled to a share of any fund collected from the radio audience at large? Many of them seem to think so, but there is really no justification at all for their stand.

How many of us would contribute money to hear a program from a poorly managed, poorly equipped station, such as many of them are to-day? If these stations put out such a request as has emanated from WEAF it is unlikely that one dollar would be contributed. There are too many stations to-day which feel they have a right to be on the air irrespective of what kind of material they send out. They appear to forget that the ether is the public's and they are on the air not by right but by tacit permission. And the public certainly has a right to send its money in to that station from which it can get the highest return.

Just as every good music lover cannot help but wish success to the Metropolitan Opera, even though this company gets a disproportionately large share of the public's opera money, just so we hope this new scheme will meet with



PRESIDENT COOLIDGE

Calmly before the calm microphone in a recent radio address. The President has three times lately made use of radio to reach great numbers of his fellow countrymen. So can the strength of the Chief Executive be saved. As the most prominent Republican candidate for the Presidential nomination in June, 1924, he may be heard quite frequently by the nation's radio listeners

extraordinary success. Even so, it must not be regarded as a final solution to the problem. We expect that it will serve merely as a trustworthy indication of the public's real desire in broadcasting. And it is the good of the general listener, not that of any station or company, which must be of chief importance in determining the method of solving the problem.

### Where Radio Broadcast Stands

PERHAPS no article ever published in any radio magazine has created as much comment as Zeh Bouck's "The Truth About Trick Circuits." The avalanche of letters reaching us expressing various opinions indicates just how badly an expression of honest belief has been needed.

For the most part the letters we have received indicate that we gave expression to thought hiding in many minds. There have been a few objections—from our friends in the industry. And we say "friends" advisedly. Let us explain:

Among the circuits treated in a most caustic manner was the Flewelling adaptation of the super-regenerative receiver. During the radio show and convention held in New York we had the pleasure of meeting Mr. Flewelling.

Amid the din of a few dozen loud speakers, all vying with each other for supremacy, Mr. Flewelling, Dr. G. W. Pickard, inventor, Zeh Bouck, and the editor sat together on a large table where admission tickets were being sold. We went right to bat, laid all our cards on the table and we are glad to chronicle the results here. Doctor Pickard appeared to be very sure that super-regeneration is accomplished by the Flewelling circuit. That may be, but our criticism was of a different nature. Our principal complaint was that the circuit, in the form in which it received so much publicity about a year ago, is a malignant squealer.

Mr. Flewelling paid us a real compliment by saying: "I have been panned many times before; but when RADIO BROADCAST took its crack at me it hit me in a tender spot. You fellows, by inference, intimated that I was party to the the unloading of "gyp" merchandise and the truth of the matter is that I was made some very flattering offers if I would place my approval on all kinds of units which could be used in my circuit. I refused them all."

Such a construction is possible from the article as we published it, but it was entirely

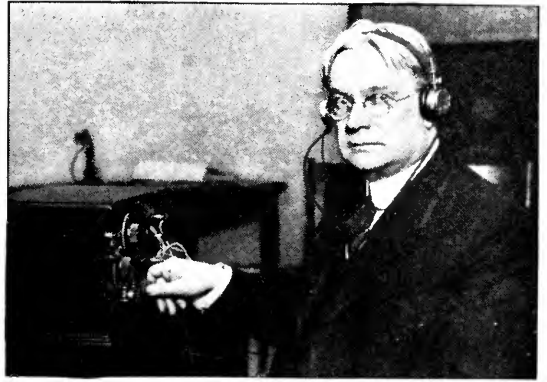

SENATOR HIRAM JOHNSON

At home before a receiving set. As another Presidential candidate, his voice may also soon be heard by radio listeners who have a bent toward politics

unintentional, and Mr. Flewelling could not prevent the exploitation of his own circuit by certain irresponsible agencies. Mr. Bouck aptly says he has been more sinned against than sinning.

Another gentleman—a prominent manufacturer of parts and sets, invited us to his office and proceeded with a rather fervent roasting. His most important criticism was that the tone of Mr. Bouck's article was not of the harmonious nature that would create interest in home-built receivers from standard parts. This particular gentleman's days are very crowded and he does not have as much time as he would like for the perusal of magazines. He was unfamiliar with the how-to-make-it articles we publish each month after we have actual working samples of the devices described.

We are firmly convinced that by keeping our faith with our readers we are serving the entire art. It is far from our policy to suggest a reduction in the number of home-built sets. That business, in our opinion, will always thrive. However, we also believe that exaggerated claims for this, that or the other circuit, will, after Mr. Home-Builder has been sadly disappointed a few times, make him doubt the legitimate claims made for even really good circuits and honest products. We hope this will correct any similar impression others among our readers have entertained.

Another manufacturer and strangely enough another maker of parts (in an unsolicited letter), says, in part:

I was particularly impressed with the article by Mr. Zeh Bouck in the March issue of RADIO BROADCAST which clarifies to the public the

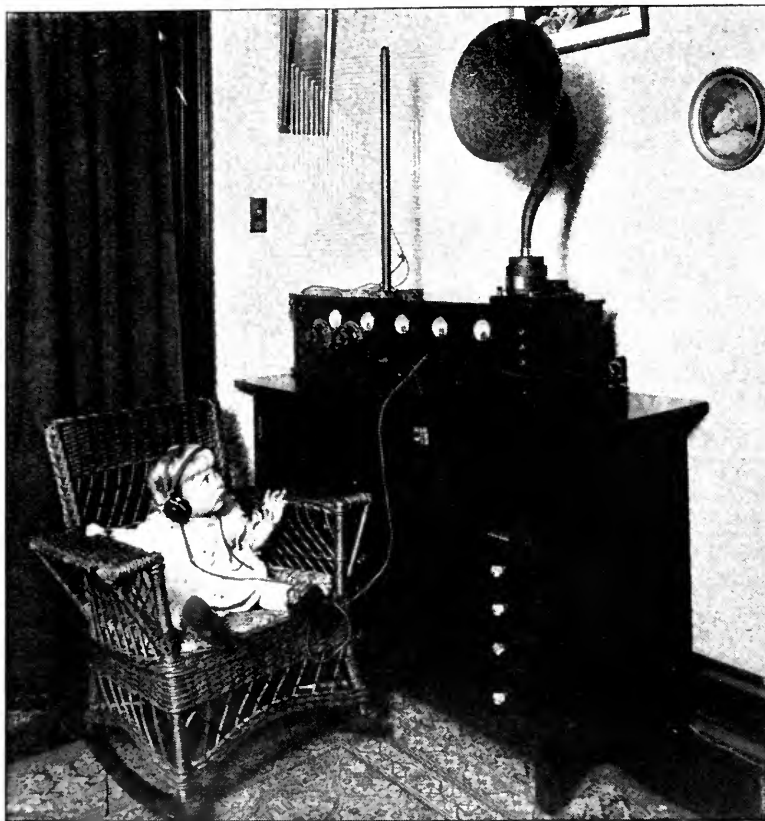

ONE OF THE YOUNGEST RADIO FANS  
Is Miss Arline Weber of Chicago. She apparently  
has no complaint to offer on the incoming program

question of "trick circuits." This has been one of the bad features of the business. It plays on the psychology of public curiosity and I think it may help to sell a lot of merchandise which will certainly put the good merchandise to the fore in time. The cause has turned the American public into a nation of experimenters who are going to register their opinion in time in no uncertain manner.

It is my personal opinion and the opinion of our company that the solution of better reception is not going to be in "trick circuits" or in various frills which will be added to the circuits, but the solution will be in the refinement, both mechanically and electrically, of the material with which we must work. We are, therefore, experimenting constantly until we find both the mechanical and electrical properties of our product to be good. . . .

The writer, who has been twenty-one years in the radio business and during that time watched its progress—both actively and in a purely observing capacity—believes that this will be the ultimate goal for which any legitimate manufacturer must strive. . . .

It is significant to note that not a single criticism from readers not associated with the

industry has, as yet, put in its appearance. On the other hand there are many—a great many of the character we are pleased to record below. As most of our older readers will remember, most of the suggestions in this good letter—from a student at Massachusetts Institute of Technology—have already been given attention. In many instances, other periodicals have campaigned against squealing receivers.

*Editor, RADIO BROADCAST.*

DEAR SIR:

I was very much pleased at Mr. Zeh Bouck's article on "Trick Circuits." You and he invited about twenty libel suits, and I admire your courage. You are the first to come out flatly, give names, and be specific. I know a few "fat-head" B. C. L.'s who believe everything they see in print. I hope they accept your article the same way.

You might razz Mr. Kaufman some more. His first circuit was, as you called it, the "goulash." He brought out another, using the reversed feedback—also a transmitting circuit. He called it the Kaufman No. 2. And I think there are thousands ruining the ether. The ultra-audion is another.

Here I am living fifty minutes from a nest of iniquity, at the Riverbank Court Hotel. There are at least 20 aerials on that roof. I tried to stem the tide of radiation. In my first interview I met a *very* well-to-do director. He thought me a fanatic! He had a Grebe "9" and listening in to his tuning was painful. He knew nothing whatever of the subject, nor his receiver, nor radio. He blamed the howls, squeals, etc., on the amateurs. What can you do with such a person? I gave up the task in disgust. *The richer* and more able to afford a non-radiating receiver, the dumber they are. The dumb owners of Colpitts oscillators, alias flivver circuits, are a great menace here in New England.

If you want to do a great service, describe only non-radiating receivers and get fellow editors to do the same.

This other request takes a lot of my nerve. It is a lot to even talk about. A good way to check radiation would be to have an issue in as many maga-

zines as possible devoted entirely to factory made and other receivers, taking each class of "pest" listing all known factory makes of that type, also aliases, and tell how to convert them into good sets. Give good notice to the Sodian tube and how to convert a single circuit into a good receiver, using this tube and without need of much extra parts except a potentiometer. Make it detailed for the "dumb-bells." By mentioning radiating makes of receivers specifically you are in little danger of a libel suit, for radiation can be easily proved, and the truth is a perfect defense for you.

I am an experimenter, and my interest in the music is little, with the exception of some very good music from good stations. Hence I am not a novice. But I would like a clean air to test in. Interference can be avoided by a good set, but the best types of receivers are helpless before radiating receivers.

Yours truly,

C. J. LeBel

### Expensive Service

PRESIDENT COOLIDGE'S speech on Washington's birthday was not broadcast from a Chicago station, as it had been announced, because the station's manager thought the service cost too much to make it worth-while. Any broadcasting of this kind is entirely dependent upon the American Telephone and Telegraph Company who control all of the long distance telephone lines of the country. Unless their coöperation is secured, practically no broadcasting can be done from points outside the studio. Thus all of the ambitious broadcasting stations, desiring to put on the air affairs which take place at distant points, are entirely dependent on the country's great communication company.

The Westinghouse engineers, with their short wave transmission from Pittsburg to Nebraska have solved, to a certain extent, the question of remote modulator control but, of course, the Chicago station could not very well set up a short wave transmitter at the White House, to relay the speech to Chicago. The General Electric Company has used a small portable short wave transmitter to actuate WGY from points a few miles away. Such a scheme is possible, but not yet as desirable as a good telephone line connection.

So the question arose—how much should a broadcasting station be charged for the use of a long distance line for a few minutes when the President is speaking? Apparently \$1000 was offered but the "asked" price did not get below \$2,500, so a sale was not made. In the

words of the discomfited radio station manager "the regular long distance charges for the use of wires from Chicago to Washington is only \$4.80 for the first three minutes and \$1.60 for each additional minute. The original plan was for the President to talk ten minutes; at the regular rates the cost of the wires would then be \$14.80. Because of the necessity of having well balanced wires and other possible special care, one Chicago station offered the American Telephone and Telegraph Company \$1000 for the service from Washington, but even at that figure the service was refused."

Before condemning the telephone company for its apparently excessive charge for this service it must be considered that the ordinary wire connection will not serve at all for such a purpose. Special lines and repeaters have to be taken out of regular service, have to be put through special tests and adjustments, all extraneous "noises" eliminated and a special



HOW KDKA WAS RE-TRANSMITTED IN ENGLAND

The receiving set had six stages of tuned radio-frequency amplification, detector and two stages of audio-frequency amplification. This special station is installed at Biggin Hill, near Manchester. In the photograph are, left to right Mr. Honri, of the British Broadcasting Company, Mr. Webb, of *Popular Wireless*, and Captain West, Assistant Chief Engineer

staff of men, as well as spare lines, be kept in readiness in case the connection should fail.

However large we may think the bid of \$2,500 for ten minutes' service may be, all of the related factors are not on the surface, and we feel that the Telephone Company is entitled to the benefit of any doubt there may be, when we consider the fine radio broadcast service they have given the public during the past year. Whatever may be the policy of their financial advisors, we do know the company makes a continual effort to improve broadcasting service. This has been of great benefit to the radio public—a public which so far has paid the Telephone Company nothing at all for the service. It is well to remember also that the radio receipts of the American Telephone and Telegraph Company are practically nothing at all whereas an organization like the Radio Corporation has an income from the radio public which must be measured annually in the tens of millions of dollars.

### Good Work by the Bureau Physicists

**A** FEW of the workers in the field of radio development have received rich material rewards for the successful solutions of certain radio problems. We think at

once of Armstrong, Pupin, Hazeltine, and others. Other workers spending months and years upon the solution of problems of great importance in the advancement of science, in the saving of lives, prevention of shipwrecks, etc, receive practically no direct financial reward when their work is successfully completed. Among such workers must be reckoned most of the research workers in University laboratories and certainly those on the staffs of such institutions as the Bureau of Standards.

Much valuable work is done by the physicists of the Bureau. This is the kind of work that practically never brings much remuneration to the worker. Tests on the applicability of short waves for radio transmission were carried out at the Bureau quite some time ago. This work is and has been of great value to such companies as the Westinghouse which, of course, gets credit from its radio audience for putting into operation the remarkable short wave channel from Pittsburg to Hastings, Nebraska. This work of the Westinghouse engineers naturally deserves much approbation, and it does get it, whereas the work of the Bureau scientists remains unknown except to a few who happen to consult the bulletins describing the work of the Bureau.

There has recently been published by the Bureau, Scientific Paper No. 480, describing a new type of radio beacon station, and its use in the navigation of aeroplanes. Ordinarily an aeroplane is guided to its port by the use of a directional radio receiver mounted on the plane itself; generally two coils at right angles, the scheme attributed to Bellini-Tosi, is employed. It is by no means easy to carry on accurate directional measurements on a noisy aeroplane, going at its tremendous speed. The Bureau workers set out to find a more easily manipulated scheme for the plane's pilot.

This pamphlet gives the results of a series of experiments made with the view of not requiring directional measurements on the plane itself. All the operator on the plane had to do was observe the signal intensity. The sending station uses two large coil antennas, mounted about 135 degrees apart. On the plane, a simple non-

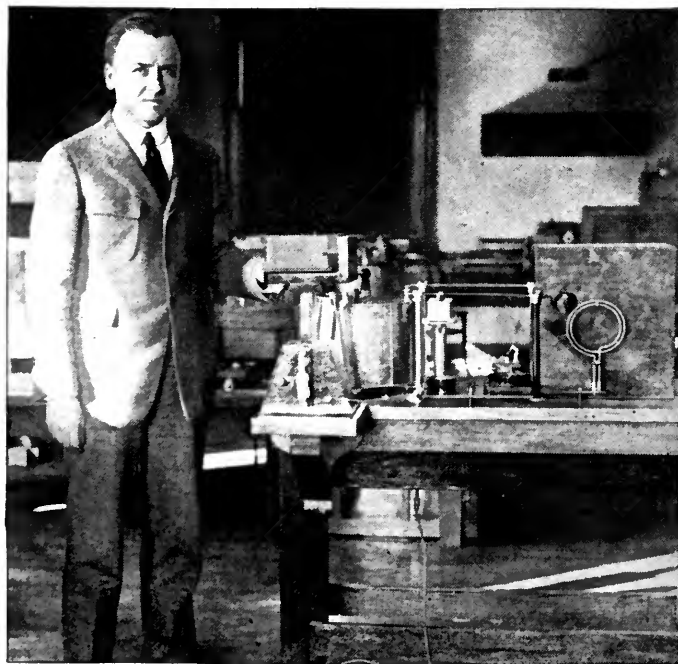

DR. J. H. DELLINGER

Of the Bureau of Standards with the standard wavemeter at the Bureau laboratory in Washington



directional receiving set suffices. Signals are transmitted alternately from the two coils at the transmitting station. On a line dividing the 135 degree angle the two signals will be received by the pilot with equal strength, but in other directions the signals from the two coils will be of unequal strength. After the radiation from this beacon is once picked up, the pilot manoeuvres his plane until the two signals are of equal strength and then holds to the line in which this equality is maintained, and he will be making a straight course for the station.

Tests carried out with the assistance of the Army air pilots seem to indicate that this new type of radio beacon will much facilitate the accurate navigation of air craft, at night or under bad weather conditions, when ordinary observational methods fail. The development of this new radio beacon was carried out by Messrs. Dunmore and Engel, physicists of the Bureau of Standards.

### "Fifty Million People Hear General Carty Speak"

SO ONE staid New York newspaper announced recently. Off hand, we thought they had slipped in one too many zeros in the linotype, but these same fabulous figures appeared the next day in even more positive form. This statement is quite in line with other confident assertions of what radio is doing. This newspaper in question should send its radio editor to an elementary class in radio principles, and then to some other necessary one in which gullible souls are taught to distinguish between solid facts and idle dreams.

The occasion which called forth this ridiculous statement was a most remarkable one; no foolish exaggeration was necessary to make possible the wording of an attractive headline. General Carty, vice-president of the American Telephone and Telegraph Company, was giving a speech to a group of business men in Chicago, and as is usual on such an occasion, he spoke on the significance of communication to the prosperity of a people, and especially on the past and future developments in the communication art as it exist in America. After pointing out that radio and wire were not in conflict, but rather supplement one another, this well known telephone engineer gave a most remarkable demonstration of the communication facilities his company had brought into being.



BETTY BALFOUR

A well-known and popular British "cinema" star before the microphone at 2 LO

Speaking into the microphone at the banquet hall in Chicago, General Carty's voice was carried over the company's transcontinental line, from San Francisco to Cuba (the step from Key West to Cuba was by means of specially constructed submarine cable). Operated by the voice currents as they traveled east and west from Chicago over this line, were six radio broadcasting stations: Havana, Washington, New York, Providence, Chicago, and San Francisco. This tremendous spread of ether waves was accurately controlled by the less than one millionth of one watt of sound which was absorbed by the microphone in Chicago. There is a picture for you.

The manager of WEAJ has estimated his average radio audience at 500,000 with a possible maximum of three million. This was the most powerful station of the six taking part in the demonstration, and, being situated in the most densely populated part of the United States, a reasonable estimate of the number of people who heard General Carty speak would be five million, at the outside. Every one of these five million must have had his imagination kindled and his admiration of the technical genius of his country enhanced, when, settled in the comfort of his home, he heard the speaker say "Hello, Cuba" and the immediate response from Havana, and then a few seconds later "Hello, San Francisco," and immediately back "Hello, General Carty, this is San Francisco talking."

It is a pity that Alexander Graham Bell's death came too soon for him to hear this demonstration of the growth of the art his



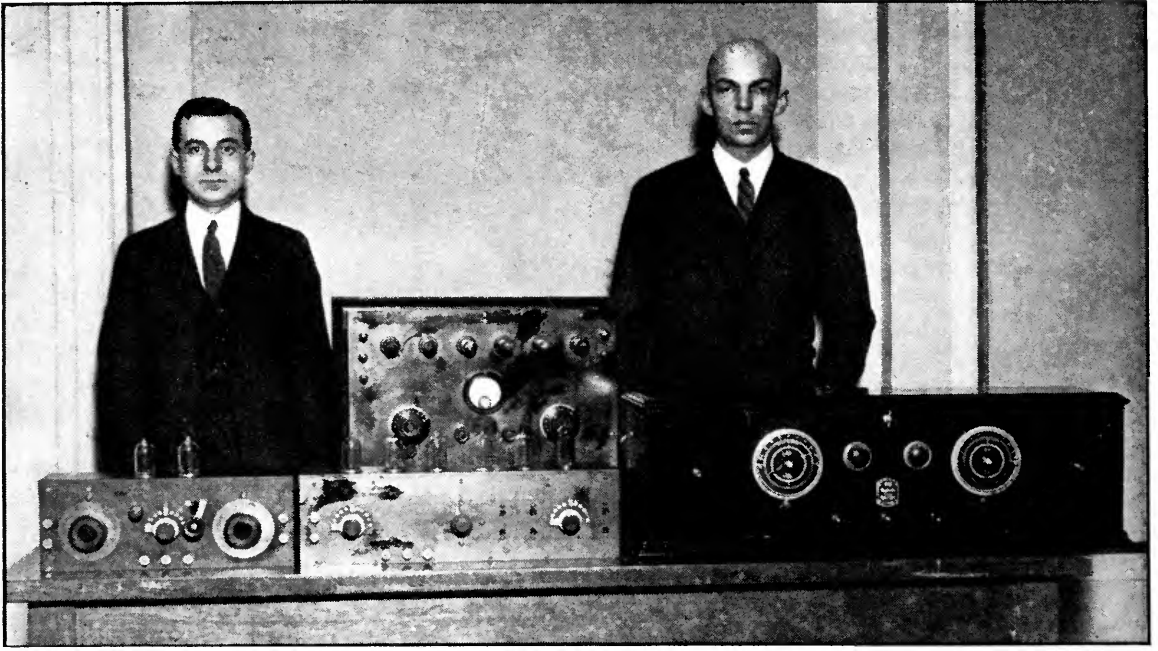

#### SUPER-HETERODYNES

And Major Edwin H. Armstrong, the originator of the super-heterodyne circuit. The cabinet on the left is his original "super," and the cabinet behind it is the working model for the finished commercial product on the right. Mr. H. W. Houck, who aided Major Armstrong in the development of the set is standing on the left

simple experiments started. He would have heard one man speak to millions, scattered over the length and breadth of our land. Even knowing the step by step progress by which this accomplishment has been made possible, it was with difficulty that we kept back the sentiment of that other message so important in the history of communications development: "What hath God wrought." We would also add, What great credit is due to those hundreds and thousands of bright, earnest, young engineers, whose diligent efforts and keen application make possible this almost unbelievable progress!

#### Radio in Great Britain

**T**WO recent news items on the radio situation in Great Britain deal with the Government's control of the radio field in that country. As we know, control of the broadcasting has been closely guarded in England. The Postmaster-General is the man whose decisions completely regulate the commercial broadcasters. He it is who tells millions of listeners what kind of receiving apparatus they may use. As related in these columns some time ago, it is illegal in the

British Isles to use a receiving set which can radiate an appreciable amount of power, a regulation which, if put into effect in our country, would rule out millions of sets. Incidentally we learn of several new stations being put up in England and Ireland. It must be that most of the listeners use crystal sets as otherwise one or two stations would surely suffice for the whole of such a very small territory.

An encouraging sign of the sensible way in which the Postmaster is seeking to wield his power justly, and in such a manner as not to interfere with the progress of the art, is shown by his acceptance of the recommendations of a committee of broadcasters, that he should appoint a Board to advise him in all the technical points involved in radio supervision. This he has done and the personnel of the Board is a source of encouragement to the radio public, according to a news item in the *Wireless World and Radio Review*. Among those appointed is A. Campbell Swinton, who was President of the Radio Society of Great Britain from 1913 to 1921. He will prove a valuable guardian of the interests of the British radio public.

But another governmental activity has lately served to arouse Guglielmo Marconi himself.

The report in question had to do with the operation of the Imperial Wireless Communications, and suggested the limitation of private enterprise in the radio field to such an extent that Marconi felt that its development would be much hampered. This is of especial importance to Marconi as he feels about ready

to go ahead with his directive radio, on a large scale. He feels that suitable radio mirrors can now be constructed, that beams of radiations can be thrown across the Atlantic or even to South Africa, with a resultant diminution in interference between stations and a very considerable saving in the power required.

—J.H.M.

# Adventures of a Wireless Free-Lance

## My First SOS—A Farce Comedy

By GEORGE F. WORTS

HERE was nothing in the least amusing about it when it was happening. We were soberly and solemnly aware that the most dramatic situation that can arise in the life of a ship confronted us. The *North American* was fast aground and lost in a heavy fog. Five hundred passengers, mostly women and children, were endangered. Responsibility for all these lives had been suddenly dropped upon our shoulders. A heavy swell—the aftermath of a gale—was lifting us and dropping us with great thumps upon a rocky shoal somewhere in the Strait of Mackinac; and the ship was canting dismayingly to starboard.

It was a tremendous moment. I had been “pounding brass” for two years, and here at last was the opportunity for which I had been secretly and shamefully hoping—the opportunity, I suspect, for which every youthful wireless operator secretly and shamefully hopes—of sitting down at the key and rapping out the three most electrifying letters in the alphabet—S O S!

I had retired to my stateroom a little after six o'clock from the midnight-to-six watch, and was asleep when it happened. A sudden jar, a deep banging, startled me awake. We had, I learned later, taken the wrong bearing on a certain light during the night, and were a mile or two off our course.

I sprang from my bunk and put my head out of the porthole. Cold white fog streamed past my face. We had been creeping through fog when I had turned in, and it seemed to me

that the fog had become thicker. It was impossible to see farther than twenty portholes in either direction and the white hull above me vanished into creamy nothingness.

From every porthole within range a head protruded, nose down. Some were men's heads and some were women's heads adorned with braids, kid-curlers and lace caps. Every one was gazing at the water, and no one said a word.

The engine had stopped and the ship was as still, as peaceful as though we were at anchor in some snug, quiet harbor. Then a long wave rolled out of the fog and lifted us. We settled down again with a harsh scraping sound and the whole ship seemed to shiver as we listed to starboard.

A woman at a porthole above me said, in an amazed voice, “Why! we're aground!” She did not seem alarmed. In fact, no one seemed alarmed. That, to me, was astonishing. I had heard that in moments such as this every one became panic-stricken. The excitement came later.

We all stared with fascination at the water. It was pale blue and so clear that we could easily see the stones on the bottom. They were of all sizes, some as small as golf-balls, some as large as basket-balls.

My stateroom door opened and Kenneth Little, the junior operator, burst in with a white face and excited eyes. He was grinning nervously.

“Well!” he got out breathlessly. “We're on!”

We exchanged glances with which every wireless operator can sympathize. Our great moment had come! No longer were we the playthings of passengers—luxuries forced upon unappreciative owners. We were, provided the *North American* did not back off the shoal under her own power, the two most important

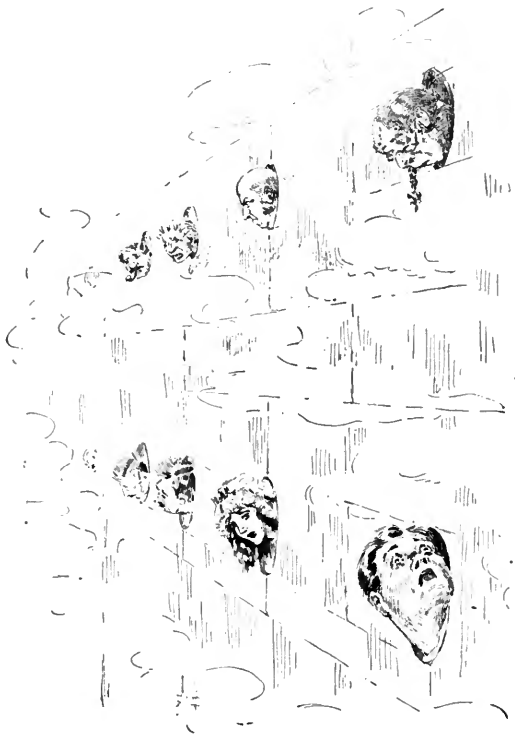

"FROM EVERY PORTHOLE WITHIN RANGE  
A HEAD PROTRUDED, NOSE DOWN"

individuals on board the ship! We were about to become heroes!

"Can she get off by herself?" I asked anxiously.

He didn't believe so. She had been running through the fog at half-speed and she had suddenly been brought to a jolting stop. It wasn't conceivable that she could back off that ledge.

Another wave lifted the beautiful white bulk of the *North American* and dropped her with a harsh deep booming still farther up on the shoal. The hull trembled as the engine started full speed in reverse. A glance from the porthole assured me that steam was being wasted. The golf-balls and the basket-balls remained stationary while bubbles from the propeller swept forward.

I had always pictured myself, when this moment came, as a man of coolness, courage, and decision.

"Get back on the job," I said crisply. "Stand by and wait for me. Test out the emergency outfit. Call up the engine-room and tell 'em we'll want plenty of juice."

"Hadn't I better send out an S O S?" he inquired hopefully.

"Not by any means," I said. "Stand by and wait for me."

"Stand by" is a phrase that has always appealed to me, along with other nautical terms such as "Steady as you go," and "Bright light two points off the port bow, sir!"

When I entered the wireless room the telephone from the pilot house commenced to ring. The first mate nervously wanted to know if everything was all right with us. I reported that we were standing by and ready to send an S O S at a moment's notice. He told me rudely to keep my shirt on and not to send an S O S without the Captain's explicit orders.

I asked him if there seemed to be much chance of our backing off the shoal under our own power.

"How do I know?" he said irritably. "Stay where you are and don't go fooling around the decks. We may need you."

It appeared that, in the opinion at least of the first mate, I was not yet the man of the hour. I devoted myself to an inspection of the apparatus.

The wireless room was situated in the starboard after corner of a square hall between-decks known as the "social hall." At one corner of the social hall was the purser's office. Across from that was the steward's office. In another corner was the baggage room; and in the fourth corner was the large glass and mahogany cage housing the radio apparatus and the newsstand. We ran the newsstand—sold magazines, candies and cigars—in addition to operating the wireless.

Our transmitter was a 2 k. w., 240-cycle rotary synchronous set—the first of its kind to be installed on the Great Lakes, and a source of endless trouble. Our receiving set was a heritage from United Wireless days, a loose-coupled tuner and a carborundum crystal detector in which we defiantly used silicon and a cat-whisker of mandolin E-string. The audition had yet to cast its pale glow upon radio scenery.

If the first mate did not appreciate our in-

portance, certainly the passengers did. They swarmed about the newsstand, asking no end of idiotic questions. How long would we be aground? Did the Captain know where we were? Was the fog going to lift? Were ships coming to our relief? How did we know if anybody was calling us when we didn't have those rubber things on over our ears?

I made the interesting discovery that human beings in moments of great crisis crave chewing-gum. Every one wanted to buy chewing-gum. And so I have come to the conclusion that gum chewing is the American way of expressing deep emotion.

We closed the newsstand emphatically. Somehow, selling chewing-gum to anxious passengers did not harmonize with the dignity of our position. We were wireless heroes, not chewing-gum salesmen!

The long waves continued to roll up under the stern from out of the fog, driving the ship farther and farther upon the ledge and tilting us more and more to starboard. The pounding did not excite the passengers, but the listing did. The opinion prevailed that the *North American* was about to turn turtle.

Within half an hour after the first impact, many of the passengers put on life-belts. The social hall was in a hubbub. Every one was asking every one else questions.

The second assistant engineer covered with mud and rust raced through the social hall and demanded the use of our telephone to the pilot house. He had been down in the bilges and wanted to inform the Old Man that no visible damage had been suffered by the garboard strakes.

"She isn't taking any water, but we're stuck tight," he reported excitedly.

The first mate asked for me.

"The Captain wants you to get hold of Mackinac Island and have a tug sent out."

"Yes, sir!" I snapped. "Where are we?"

They didn't, it developed, know exactly where we were.

"On one of the Duck s," he guessed. "Tell the tug to nose around the Ducks. We're probably on Little Duck."

"Yes, sir!" I snapped. A picture came into my mind of the Old Man and I in the act of leaving the ship—sticking to our posts to the very last, while the ship was ground to flinders on one of the Ducks.

This vision possibly was prompted by a sudden and sickening realization that the Mackinac Island operator would not be on the job for at least an hour. It was still very early in the morning.

There was nothing else to do, so I started the motor-generator and called WHQ—the Mackinac Island station. There was no response. At that time of day no one was on the air. Even the static seemed to be reposing.

The telephone rang again, and this time the voice of the first mate was agitated.

"Has that tug started?" he wanted to know. I told him that the Mackinac Island station wasn't open and wouldn't be open for another hour.

"You've got to get word to Mackinac somehow," he said. "We can see land now. We're on Little Duck. This wind is freshening. There isn't any time to lose, Sparks. Get busy!"

I got busy. Futilely I called WHQ. I called and called and called. The operator probably hadn't left his boarding house. It was a tormenting situation. In desperation I called VBB, the Canadian Marconi station at Sault Ste. Marie. Someone was always on duty in VBB. He could put the message on the land line to Mackinac Island. Then I realized with a sensation of sickness that the Western Union office at Mackinac Island did not open until WHQ opened.

VBB did not answer. I called him feverishly for five minutes. Then I rang the pilot house. The Captain answered. I told him that I had tried to raise Mackinac Island and the Soo, but that no one answered.

"See if there isn't some ship near us," he replied.

"That means an S O S," I told him.

"All right—send as S O S!" he snapped. "But get somebody. What are you fellows being paid for?"

And so the great moment came, not precisely as I had wished, perhaps; but here, at all events, it was. After two years of faithful brass pounding I was about to send my first S O S! I was divided between perspiring agitation and a consciousness of the part I played in this epic maritime drama.

Kenneth, the junior operator, looked at me enviously as I slipped into the chair and grasped the handle of the motor-generator starter.

"S O S?" he gasped.



"Yes," I said fatefully. "It's S O S! Keep that door shut! There's somebody else who wants some gum!"

It opened even as I shouted the warning. A perspiring young man with disheveled hair and wild but determined eyes forced his way inside. The eyes of dozens of passengers on the other side of the glass stared at us expectantly. In his hand the young man had clasped a sheaf of papers covered with pencilling. He was a reporter on the *Chicago Examiner*, and this story was, of course, a big one. Nearly all of our passengers were Chicago people. It was a front-page story, worthy of a seven-column streamer.

He shoved the pile of paper at me.

"I want to get this right off," he panted. "It's press. It has right of way over all traffic. It's to be sent collect."

He produced documentary and other evidence to support the statement that he actually was a reporter. Sweat was streaming down his face, and sweat was streaming down mine. I was trying to push him out of the room. He was trying to push me into my chair. We weren't making much progress.

"Look here," I said dramatically. "I am in the midst of sending an S O S. How dare you break in here!"

"The devil you are!" he cried. He snatched the paper from my hands and wrote rapidly

on the top sheet: "Radio men sending frantic calls for help!" I glanced bewilderedly over his shoulder at other things he had written. The *North American*, I learned, was slowly being pounded to fragments by a savage sea on the gleaming fangs of a rockbound coast. Women and children were running screaming about the decks. The ship's officers were determinedly setting them an example of coolness and courage. The lifeboats were in readiness. A furious gale was blowing up. The lives of five hundred Chicagoans were in acute peril.

"That's bunk," I snorted. "I won't send that stuff. We aren't being pounded to fragments. Nobody's screaming, and a gale is not blowing up. You better let the skipper see that."

"This is press," he shouted. "If you don't send it, I'll have you prosecuted! There's a law that says—that says—"

"If you don't clear out of here," I stopped him, "I'll have you put in irons. You're interfering with the despatch of a distress signal." I appealed desperately to my partner. "Ken, get him out, will you?"

Kenneth grappled with our natural enemy while I sidled into the chair and started the generator. The reporter broke away from Kenneth and shoved his one-act melodrama beside my sending arm. My hand was already at the key.

"Won't you *please* get it off when you're through with that SOS?" he begged, and there were tears in his eyes.

"I'll have to edit it first," I said angrily.

"If you touch a line of that copy," he shrieked, "I'll have you jugged the minute we hit Chicago! I'll break you! I'll beat you up! I'll have your license taken away! I'll——"

Kenneth pushed him out into the crowd in the social hall, and he was shaking with sobs. I could have brained him. He had cheapened my grand dramatic moment and set every nerve to jumping.

My fingers danced on the key.

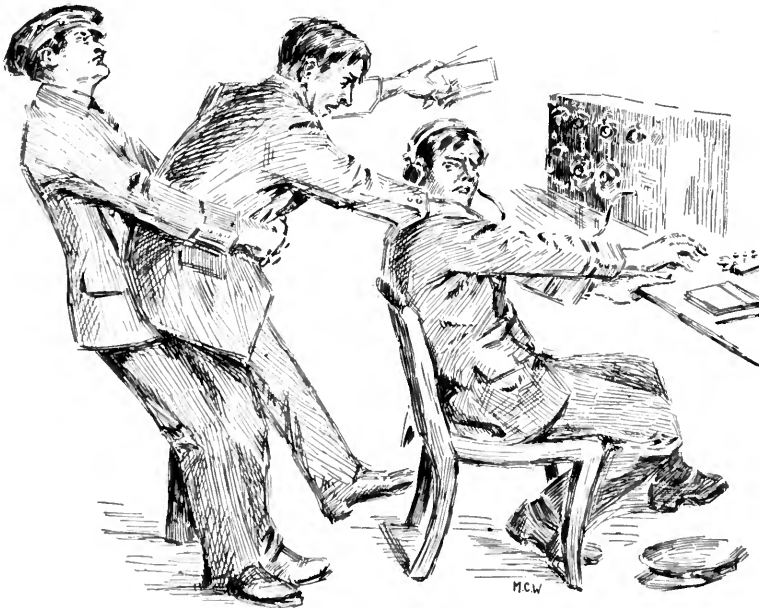

"I AM IN THE MIDST OF SENDING AN S O S. HOW DARE YOU BREAK IN HERE!"

"Z Q P!—S O B!—F O S!" the spark stammered. Then I steadied my hand and ripped off a string of very creditable S O S's.

I threw over the aerial switch to the receiving position. The mournful lazy drawl of a big ore freighter came instantly out of the fog. The name of the ship is forgotten.

"Where are you, O M?" I have always disliked operators who use that solicitous and ingratiating phrase O. M.—"old man." "Are you sinking, O. M? You come in good and loud, O. M. Stick to the ship, O. M."

I coldly informed him that our danger was not yet acute, that we were aground on Little Duck Island and wanted to have some one tow us off.

He replied with a series of irritable "g's". That meant, in those days, "I am being interfered with." I wondered who could be jamming us, and while I wondered the smooth buzz of VBB, the Soo, enlightened me.

"What is your position?" he asked. "Are you in immediate danger?"

I told him to stand by, that he was jamming me, and called the ore boat. VBB came back, insisting on having my position, and a report on the character of our predicament. He additionally wanted to know why I had sent an S O S without first calling him. My nerves were on edge from that tiff with the reporter, and I told him sarcastically that it was a real nice day and I hoped he had enjoyed his smoke. I used profanity freely.

He informed me that the use of profanity was strictly forbidden on aerial circuits and was punishable by a fine and a long term of imprisonment under section 112-A or 233-B or 40-11-X of the International Radio Regulations.

"You should be ashamed of yourself to use such language in a situation as grave as this." Presumably he meant that my chances of getting into Heaven were imperiled. He finished his sermon, and I again addressed my invisible friend on the freighter. Where were they? He reported that they were just rounding McGuipin Point, northbound, which meant that it would take them hours to reach us. That hope was too dim.

I resorted to a few more S O S calls, mingling the distress signals with calls of WHQ, and, when I signed off, WHQ's rasping spark answered. In all of my years of operating, I have never been so relieved to hear a spark.

Complications immediately ensued. The operator at WHQ (there was but one) was then very new to the game. I am glad to say that he later became an expert operator.

His reply to my S O S was bewildering. After wishing me a courteous good morning and making inquiries touching upon the state of my health, he sent me all of the baseball scores for the previous day. He then proceeded to furnish me with long selections from the overnight news. He was not absolutely to blame. For time-saving purposes, we had abbreviated the request for ball scores to the three letters S B S—send ball scores. The similarity between S B S and S O S is noteworthy. Perhaps he was sleepy that morning.

When he was through regaling me with the topics of the day, I slowly and patiently informed him that it was succor and not base ball scores that I had asked for. Here we were, piled up on the rocks, every moment precious, and he was using perfectly good electricity to tell me that Charlie Chaplin had just signed a contract for \$1,000 a week. Good God!

For several seconds there was no intelligible response from him—only the stuttering of his spark as his paralyzed hand tried vainly to work the key. In broken Continental he presently told me to stand by a moment while he telephoned the waterfront for a tug. . . .

And so my heroic moment came, was lived, and passed. I telephoned the Captain that a tug was on the way. I read the stirring one-act melodrama with its cast of five hundred screaming women and children supported by the ship's officers who set their cool and courageous example. I tore it up and dropped it into the wastebasket. We were on a popular run; and that story, had it been published in Chicago, would have ruined our passenger business for the rest of the season. The reporter threatened me with sundry revenges, none of which I suffered.

After WHQ had assured me that the tug was on her way, the tension subsided. It was all over. Kenneth and I were once more commercial wireless operators. A wonderful opportunity had been given us to do a land office business.

"Go out and pass the word around," I suggested, "that when news of this reaches Chicago, all their relatives and friends will be

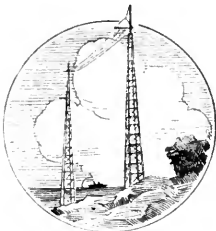



“LOOK! THERE GOES THAT WIRELESS OPERATOR!”

scared green. Drop the hint that it would be a good plan to send radios reassuring them.”

It worked very nicely. Kenneth took charge and I went on deck for a breath of fresh air. The fog had evaporated and the warm Michigan sun beat brightly down upon sparkling blue water—and a little island covered with evergreens a few hundred yards ahead. The news had travelled magically over the ship that a tug was on the way from Mackinac Island and that there was nothing now to worry about.

I was proud of myself. Very few wireless

operators had gone through this ordeal. I had sent my S O S—a very authentic and dramatic S O S—and was one of that noble company captained by Jack Binns. I glanced up affectionately at the smoke-blackened four-strand antenna and heard a man exclaim:

“Look! There goes that wireless operator!”  
And a very pretty girl said, in awed tones, “Gee whiz!”

I pretended not to hear. With head up and shoulders back, I proceeded on my way.

Don't be uncharitable. I was only nineteen.



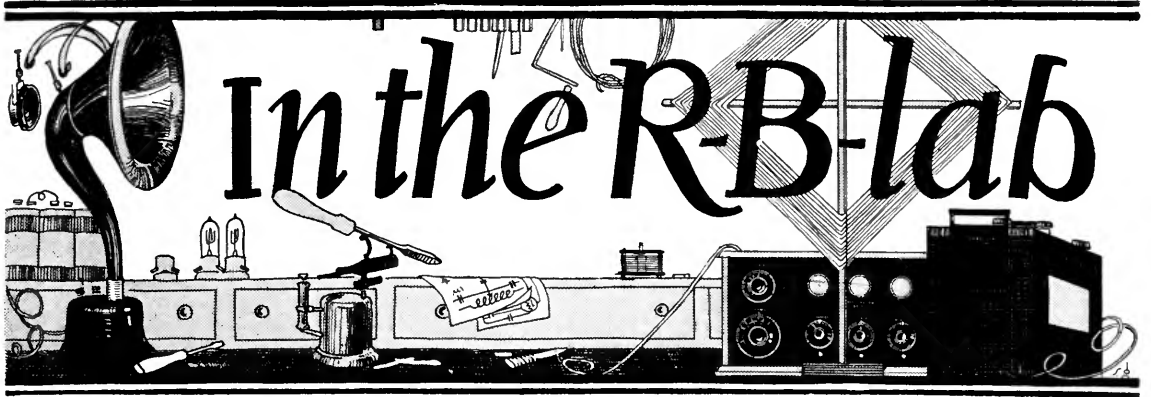

## USING HONEYCOMBS IN THE KNOCK-OUT REFLEX

THE use of different forms of inductances in the RADIO BROADCAST Knock-Out Reflex circuit, such as the straight winding and the spider-web heretofore described in this department, has suggested to many of our readers and to the RADIO BROADCAST laboratory staff, the possibility of using the honeycomb inductance. Our experiments have shown that the experimenter and builder will encounter little difficulty in adopting this form of inductance as the main winding in the reflex circuit.

In reference to the diagram shown on page 327 of the February RADIO BROADCAST, our readers who have been following up the development of this circuit (and they are many) will recall the following specifications for T<sub>1</sub> and T<sub>2</sub>. Using a two and a half inch tube, the

secondaries were first wound, sixty turns being used for each transformer. The primaries consisted of fifteen turns for T<sub>1</sub> and thirty-five turns for T<sub>2</sub>, wound over the secondaries, with an insulating layer of paper between.

The simplest way of substituting the honeycomb coils, is using them as the secondaries, winding the primaries over them as usual. Figs. 1 and 2 show a set built up in this manner. Honeycomb or duo-lateral coils, No. 75 were used as the basic inductances. Twenty-five turns of wire were removed from each coil, leaving 50 turns (in the case of the DL, the equivalent). The inductance per turn of the honeycomb coil being greater than that of the layer type inductance, the result is about equal to the usual sixty turns. An eighteen-inch strip of cardboard is wound over each secondary

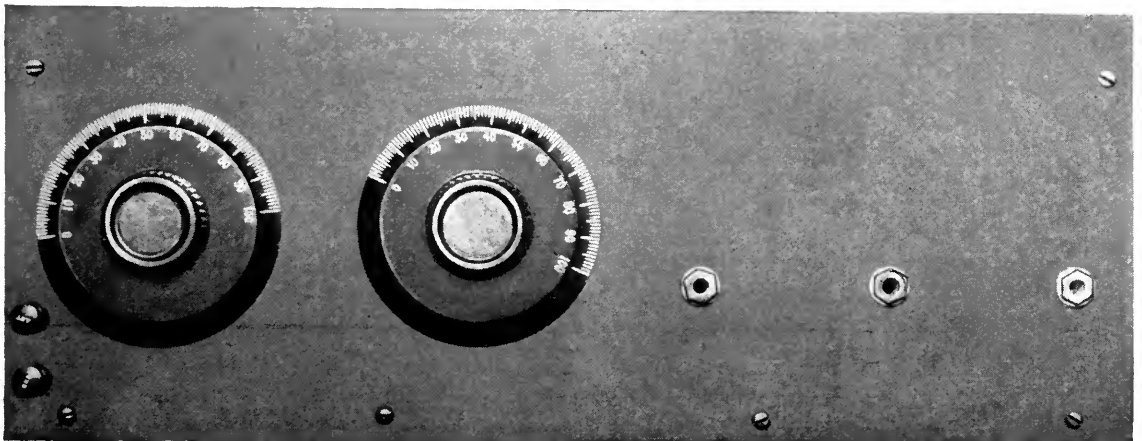

FIG. 1

Front view of reflex and two step, using honeycomb inductances

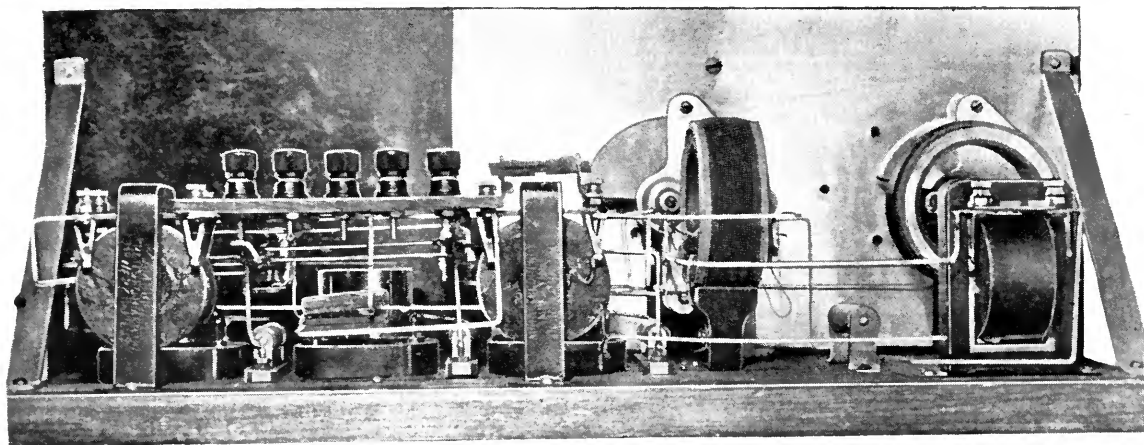

FIG. 2

Rear view of reflex and two step using honeycombs. Amperite resistances have been used in place of rheostats

coil which acts as an insulating layer between the two windings. The cardboard also loosens the coupling, increasing the selectivity of the set.

The 15- and 35-turn primaries are now wound over the secondaries. The 15 turns present no problem whatever. However, due to the narrow winding space, the 35-turn primary must be single bank-wound. Details on bank-winding will be found in the Grid department of the February RADIO BROADCAST.

The reader may find it easier to make the primary windings, by building up the winding form to the correct size, and slipping it over the secondary when wound.

The completed reflex (Fig. 1) plus two stages

audio was constructed in accordance with the instructions outlined in the February RADIO BROADCAST. The anti-squeal condenser is a .001 mfd. Dubilier Micadon. However, a larger panel, 7" x 18" was used. This permits a nicer layout, with less cramping of instruments. The panel working drawing is shown in Fig. 3. The base is  $17\frac{1}{4}'' \times 6\frac{3}{4}'' \times \frac{3}{4}''$ . The sockets are spaced three inches between centers, as are the jacks. Thirteen-plate, or .00025 mfd. variable condensers were used, with four-inch dials. Due to the size of the panel, it was thought better to support it by brackets, rather than permit the entire strain to be taken up by the rigid wiring and the screws into the base. The brackets were made from brass strips,

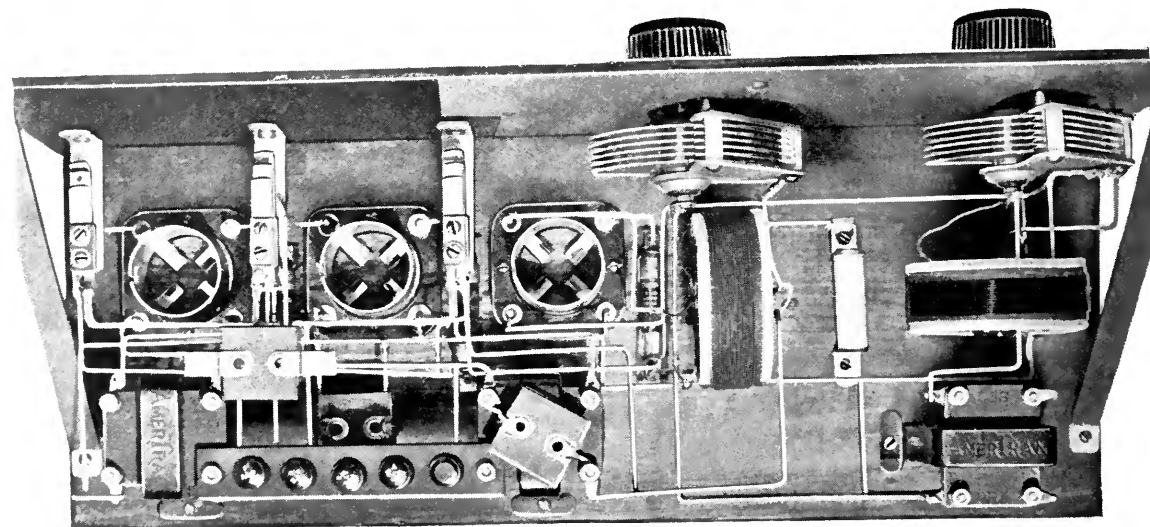

FIG. 2A

eight inches long, one half inch wide and  $\frac{3}{8}$  inch thick

A NOVEL BINDING-POST STRIP

WE CALL the attention of the reader-experimenter to the mounting of the binding-post strip which, perhaps, will appeal to him as a novel and efficient method of providing for rear connection in all apparatus having two similar audio transformers. This method eliminates a bit of machine work, conserves space, and raises the binding-posts to a convenient height for soldering connections to the nuts.

BACK-OF-PANEL MOUNTING FOR SPIDER-WEBS

(Data by MR. GEORGE BEANE, JR.)

MANY of our readers have refrained from using spider-web coils, a very efficient form of inductance, due to the fact that mounted in the conventional way on the front of the panel, they are a clumsy and unsightly projection. Mr. Beane, however, has obviated this objection in an ingenious and very efficient manner—efficient because of the possible micrometer adjustment, and the absence of body capacity effect.

The drawing, Fig. 4, explains the idea so clearly that there is little need for a detailed description.

The wood strips to which the coils are

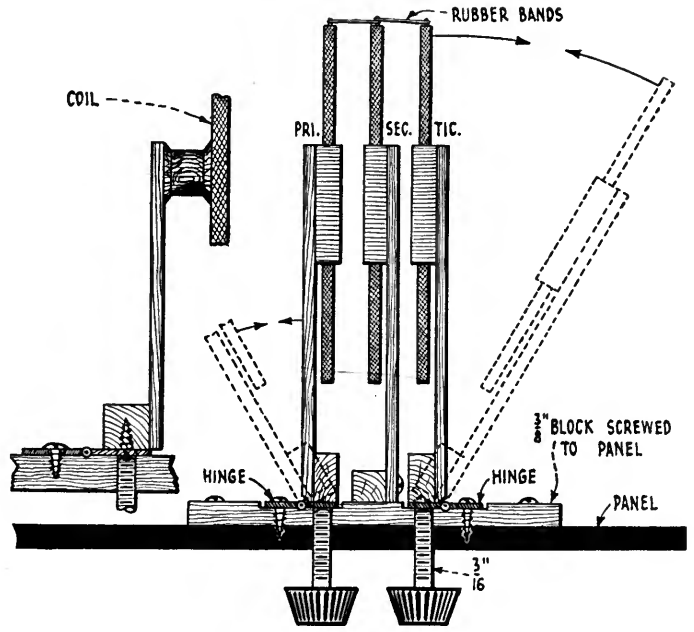

FIG. 4

How to mount your spider-web coils behind the panels

fastened, are cut from a cigar box. They are glued to the inductances, and to small blocks at the inside or panel end, to which are screwed small brass hinges obtainable from any hardware store.

The brass rods threaded into the knobs and panel may be any convenient size and thread. The ends against the hinges should be filed round.

If, for the sake of appearance or dials, it is

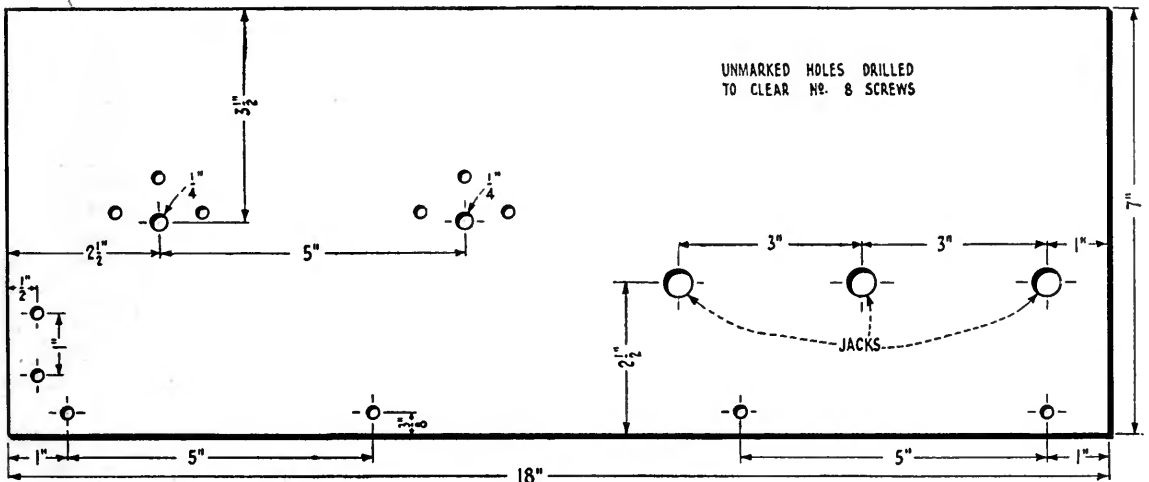

FIG. 3

Panel layout for the reflex and two step

desired to separate the control knobs farther than shown in the main sketch, this is easily done by gluing an empty thread spool between each wooden arm and the coil, as shown in the insert.

Rubber bands supply the tension tending to bring the coils into close inductive relation. By adjusting the bands on different prongs, the tension may be varied.

Honeycomb coils mounted in this manner will appeal to the experimenter using the three-coil tickler regenerative circuit, advocated as a standby set in the March Grid department, and the super-heterodyne, in which a very efficient oscillator-coupler may be made of spider-web inductances. For the latter RADIO BROADCAST suggests a winding form having an odd number of spokes, about nineteen, with a beginning, or minimum diameter of one and a half inches. The pick-up, secondary and tickler coils should be wound with respectively 25, 35, and 50 turns of wire.

### AN OPERATING SHELF FOR THE PORTABLE AUTOMOBILE SET

【Photo by MR. C. H. BROWN】

**A** CARRYING-CASE arrangement for the ideal portable automobile receiver was described in this department last month. That, however, is only one-half the story. The operation of even the most suitable equipment is marred if it is set up on the running-board,

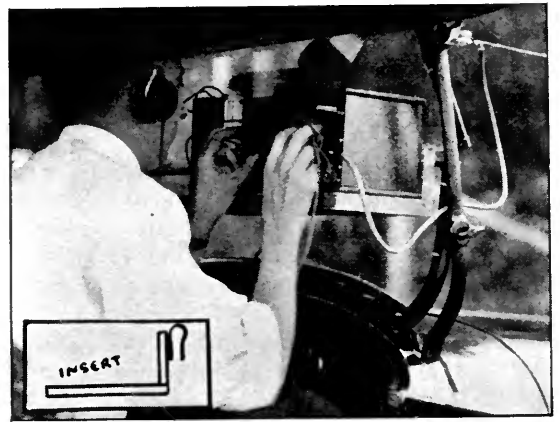

FIG. 5

The windshield shelf for the portable auto-set

the rear seat of the car, or on the ground at the mercy of clumsy and careless picnickers.

Mr. Brown, who designed the carrying-case and equipment, has devised a clever windshield shelf for the operation of his set, from a comfortable seat at the most convenient operating height. The photograph of Fig. 5, with the insert, clearly explains the construction and mounting of the shelf.

The lead-in and beginning of the antenna are also shown in the photograph, and exhibit the neatness and system which adds so materially to the comfort and pleasure of auto radioing. The shelf should be used, of course, only when the car is standing still.

The interested reader will find other details on the portable auto equipment in the April Lab Department.

### WIRE YOUR HOUSE FOR RADIO

**A**RE you at present building a home, or having plans drawn up for one? If so, instruct your architect when making provisions for electricity, plumbing, heat, etc., not to forget your radio receiver which has become as important a convenience as the less novel facilities.

Fig. 6 indicates the scheme followed out by Mr. George Hofe of South Orange, New Jersey, in which antenna and ground outlets are provided in all rooms where he will

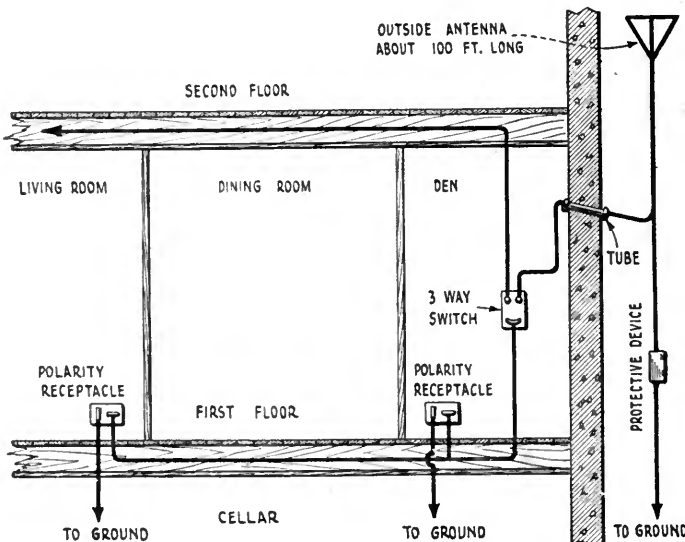

FIG. 6

A tentative plan for wiring your house for radio

be likely to enjoy reception. In Mr. Hofe's new home, he will plug in his radio set as you, perhaps, now do your electric toaster or vacuum cleaner.

Polarity receptacles and plugs are used. This insures the correct line up of antenna and ground without experimental plugging-in. A three way switch, close to the entrance of the lead-in, makes it possible to cut off all indoor leads if at any time, it should be deemed desirable.

Individual grounds are provided at each polarity receptacle.

The architect, in designing your particular home, might go even farther, and, taking into consideration surroundings, trees, etc., and, perhaps, provide antenna mooring in the way of an artistic mast or tower.

### A STANDBY RADIO FREQUENCY SET

MANY of our readers, perhaps not desiring to hazard some of the newer radio frequency developments, have requested a conventional radio frequency circuit, which may be depended upon to work without excessive experimentation. And there are many rather hasty enthusiasts who would benefit from building such a set before venturing on the more precarious Grimes arrangements and the super-heterodyne.

Complete descriptive drawings of such a layout are shown in Figs. 7 and 8. The parts

are all standard, and we suggest, as R. F. transformers, such reliable makes as the Acme or Murad. A 7" x 24" panel will be about right.

A square solenoid or box loop is suggested, four feet on a side. Nine turns of wire, spaced one half inch, will cover the entire broadcasting range. If it is desired to use an antenna, with greatly increased range and volume, a tuning coil, such as described by Mr. Sheehy in the Laboratory Department for March, may be wound.

This combination has enabled James W. Brennan, of Beverly, Mass. to build up a very creditable DX record.

### BUILDING YOUR OWN LAB

FIG. 9 shows how to use dividers, RADIO BROADCAST'S suggestion for this month's addition to the growing amateur laboratory. Seven inch dividers is the most common size, and should cost in the neighborhood of seventy-five cents. They are as indispensable to fine panel layout, as is the compass in drawing.

In combination with the ordinary one foot rule, many otherwise difficult panel maneuvers become as easy as drawing a straight line. No templates are required for the mounting of variable condensers, rheostats, etc. The correct distances are measured with the ruler, to one thirty-second of an inch if necessary, and the dividers are spread to span this exactly.

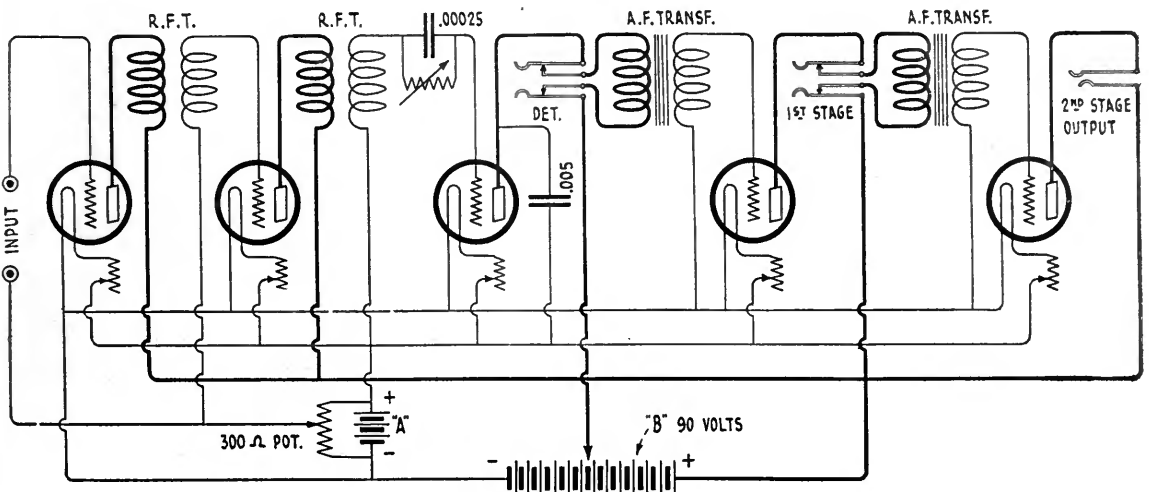

FIG. 7

The circuit for a standard transformer coupled R. F. set

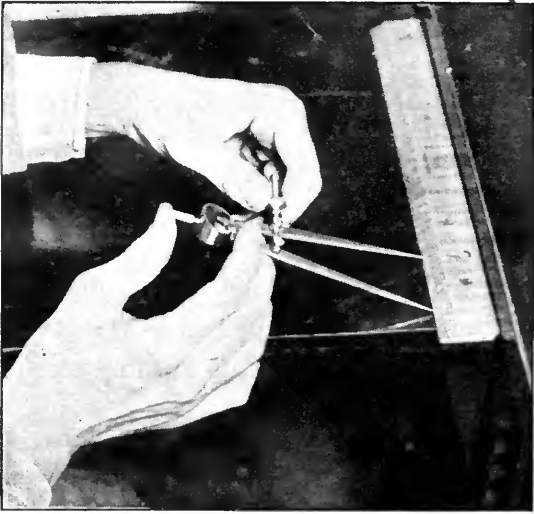

FIG. 9  
How to use dividers

The intelligent use of dividers will cut the time of preparing a panel for drilling by half.

A NOVEL USE FOR DIVIDERS

THE R. B. LAB has found the dividers a most handy tool to facilitate the soldering of connections to small condensers of the Dubilier Micadon type. The points of the dividers are placed through the eyelets of the condenser, and the spring released. The condenser is thus held firmly, and may be moved about and adjusted for soldering in places inaccessible to fingers.

*One way to eliminate undesirable radiation from your single circuit regenerator is to use Mr. Bouck's "Reflexit" (see page 7). Later numbers of this magazine will contain, in the Lab Department, instructions on how to convert other types of oscillating receivers to unoffending circuits.*

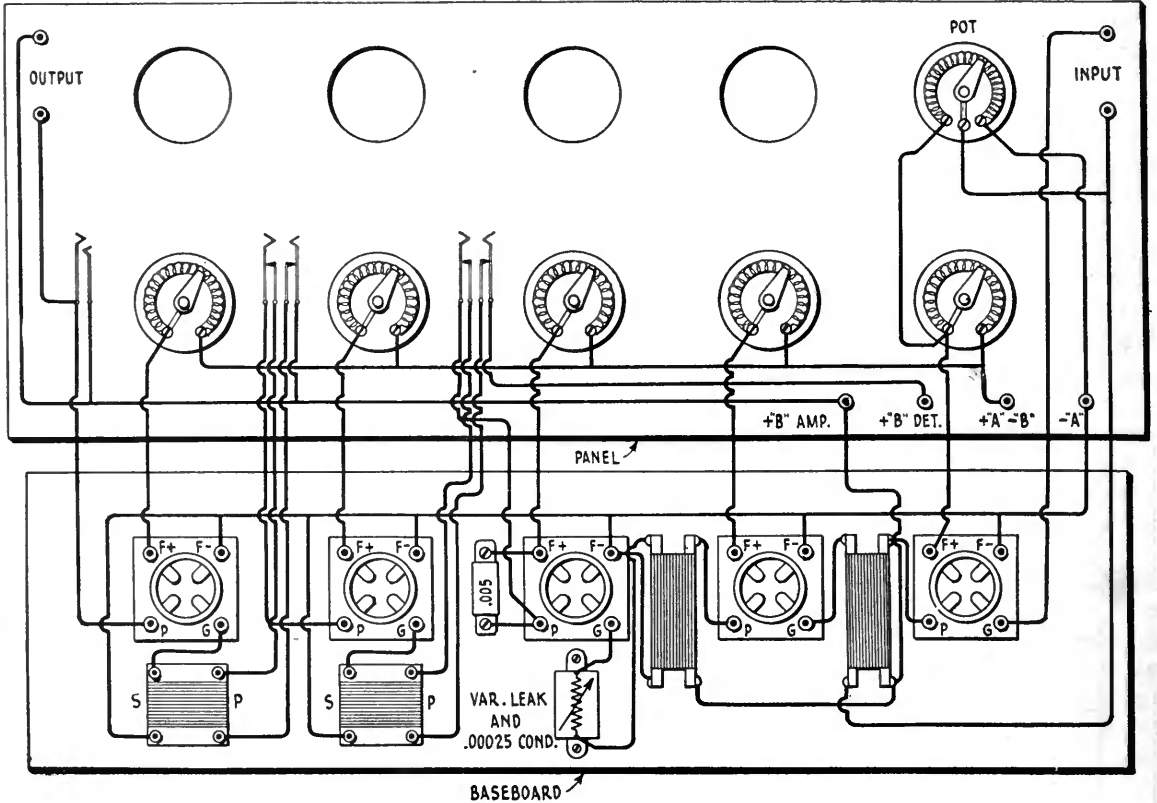

FIG. 8  
The panel layout and base, showing the placing of instruments

# How to Build a Resistance-Coupled Amplifier

An Inexpensive Three-Stage Amplifier Unit Which Will Give Distortionless Amplification

By G. Y. ALLEN

Westinghouse Electric & Manufacturing Company

THE three-electrode vacuum tube is in itself a very good amplifier of electric voltages. Tubes have been constructed whose plate-to-filament voltages range as much as thirty to forty times the grid-to-filament voltage variations. Furthermore, within certain limits, this voltage amplification is substantially a linear relation.

Where power must be absorbed from the output side of a tube, however, high amplification factors, with their accompanying high plate impedances, require high B battery voltages in order to maintain the linear relationship between the input and output sides. These considerations limit the design of practical tubes to those having an amplification constant of from 6 to 8 and plate impedances ranging around 20,000 ohms. Such tubes work very well as amplifiers using from 45 to 150 volts B battery.

## THE PLACE OF THE TRANSFORMER IN AUDIO AMPLIFICATION

NOW it is a well defined law in electrical engineering that the most efficient conditions are met in any device supplying electric power when the impedance drop across the power consuming device is the same as the impedance drop across the device supplying the power. When using two or more tubes in cascade amplification, the grid circuit of any tube is the load consuming device for the plate circuit of the preceding tube. But the grid impedance of a vacuum tube as it is used in an amplifier is very much greater than the plate impedance. Thus, if two or more tubes are connected directly in cascade without intervening apparatus, great amplification will not result. This condition has made very popular the practice of using step up transformers between the plate circuit of one tube and the grid circuit of the next tube, which transformer presents to both the grid and plate circuits impedances permitting the tubes to be worked

at their most efficient point. Furthermore the inherent voltage amplification factor of the tube is multiplied by the step up ratio of the transformer resulting in greatly increased amplification per stage.

Were amplification all that were to be considered, transformer-coupled amplification would be ideal. With the advent of good broadcast transmission, however, and with the production of good loud speakers, the broadcast listener's standard of quality has crept steadily upward. A transformer, being essentially an inductance cannot transform all voice frequencies with exactly the same amplification no matter how carefully designed, with the result that *all amplifying transformers suppress the lower and favor the higher frequencies*. True, great improvements have been made in transformer design, but the fact remains that fundamentally the transformer cannot ever give distortionless amplification.

## WHEN RESISTANCE-COUPLED AMPLIFIERS ARE DESIRABLE

FOR those who demand quality at all cost, the resistance-coupled amplifier is unquestionably the most desirable. The amplification per stage is not as great as with transformers, but a nearly absolute linear relation holds between input and output.

A curve showing amplification plotted against frequency for a transformer as compared with the linear relation existing in a resistor is shown in Fig. 2. It will be noted that the amplification of a transformer, and the curve is shown for one of the best transformers on the market, falls off very rapidly below 200 cycles. In other words, all notes below middle C on the piano are reproduced much below their normal amplitude with resulting loss in quality. On the other hand (Fig. 3), the amplifier using resistance-coupling shows nearly constant amplification throughout the range of frequencies plotted, although some-



what less in amplitude. To compensate for the reduction in amplitude, it is generally customary to use one more stage than would be used in a transformer-coupled amplifier.

In designing a resistance-coupled amplifier, the theory indicates that the greater the values of the coupling resistance, the greater the amplification per stage. That statement can be proved this way:

Let  $E_g$  = AC grid voltage of first tube.

$E_p$  = AC plate voltage of first tube.

$R_p$  = AC plate resistance of first tube.

$I_p$  = AC plate current.

$\mu$  = voltage amplification constant of tubes.

$R_c$  = resistance of coupling resistor.

From fig. 2 it will be evident from Ohm's law that

$$E_p = I_p (R_p + R_c)$$

$$\mu E_g = I_p (R_p + R_c)$$

$$\therefore I_p = \frac{\mu E_g}{R_p + R_c}$$

Also  $E_g = I_p R_c$

and  $E_p = \mu E_g \frac{R_c}{R_p + R_c}$  (Assuming negligible impedance in coupling condenser)

It is evident, therefore, that the greater the coupling resistance  $R_c$ , the greater will be the voltage applied to the grid on the second tube for any potential applied to the grid of the first tube, and therefore the greater will be the amplification.

However, it is plainly evident that the coupling resistor being in series with the plate battery will reduce the part of the plate battery voltage applicable to the plate. There is an upper limit, therefore of coupling resistance, beyond which it is not advisable to go, on account of the large amount of B battery required. Fig. 4 shows the detailed circuit where  $R$  are the coupling resistances.

#### WHAT YOU NEED

THE photograph Fig. 1 shows very clearly the arrangement of the parts on the base board. That is the reason no base layout is

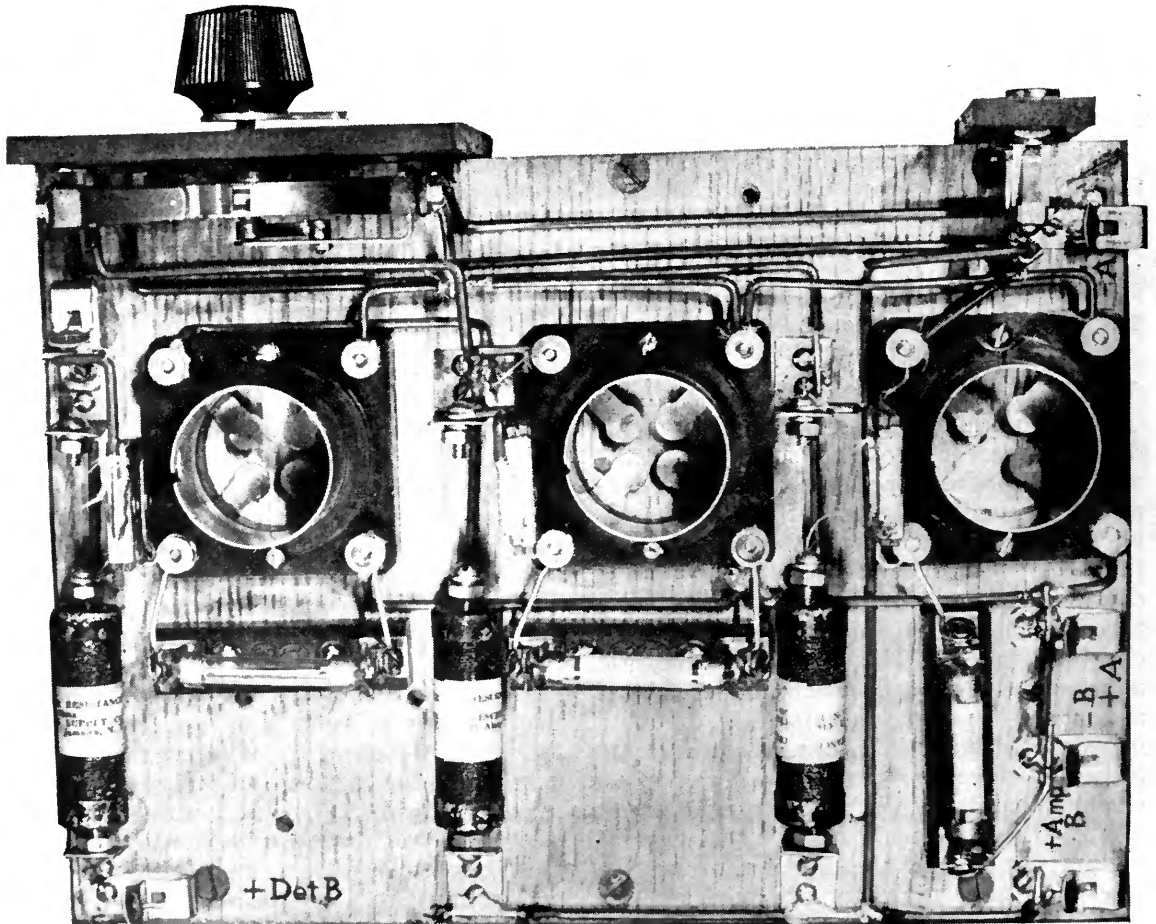

FIG. 1

The complete unit mounted on a base. All wiring is protected by spaghetti tubing. The construction is not at all difficult and the cost of parts quite low. This amplifier gives perfect quality

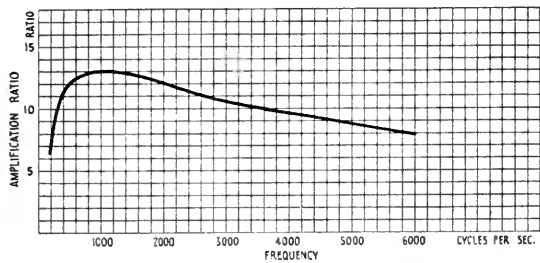

FIG. 2

Shows the relation at various frequencies between the ratio of amplification to the frequency supplied to a transformer

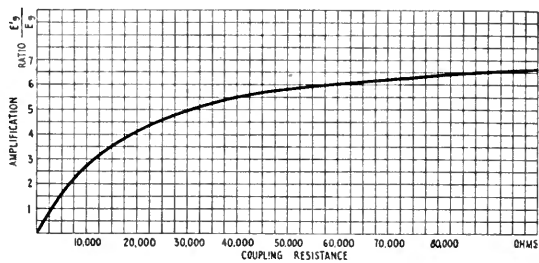

FIG. 3

How the amplification varies in the resistance-coupled amplifier with an increase in value of the coupling resistor. Nothing is gained by using resistors of more than 100,000 ohms

given. The list of the parts required is given below.

	APPROXIMATE PRICE EACH
A <sup>1</sup> , A <sup>2</sup> , A <sup>3</sup> , Ward Leonard Resistance Tubes, 20,000 ohms resistance	\$2.00
or Lavite Resistors 50,000 or 100,000 ohms manufactured by Crescent Radio Supply Co.	1.50
B <sup>1</sup> , B <sup>2</sup> , B <sup>3</sup> , Any standard type of socket	.75
C <sup>1</sup> , C <sup>2</sup> , C <sup>3</sup> , Radio Corporation type UX 543 grid leak mounting	.50
Grid leaks	.50
D Carter Rheostat, 6 ohms	1.50
E Carter pin type jacks	.25
F <sup>1</sup> , F <sup>2</sup> , F <sup>3</sup> , Dubilier Micadons capacity 0.0025 mfd.	.40
G <sup>1</sup> , G <sup>2</sup> , G <sup>3</sup> , Fahnestock Connector Posts (or similar standard parts can be bought, where the builder prefers one product over another).	.10

The rheostat and pin jacks are mounted on hard rubber, bakelite, or micarta panels which are attached to the side of the board. All of the other parts are mounted on the board.

THIS AMPLIFIER IS SIMPLE TO CONSTRUCT

THE amplifier described herein was designed at the suggestion of the editor of RADIO BROADCAST. It can be manufactured from parts that are readily obtainable and it is felt that the constructor will be well repaid for his efforts.

The particular amplifier described was laid out with simplicity as the keynote. Its appearance is more that of a schematic diagram than an assembled set, but the layout is arranged for taking either Ward Leonard or Lavite resistors. These tubes are supported by small brass L pieces as shown in photographs and the two detailed drawings. It was felt that in this way the basic design could be best described and that those desiring to incorporate a resistance-coupled amplifier

in a cabinet could easily modify the arrangement of the parts to suit their conditions.

Fig. 3 shows how the amplification varies with the increase of the coupling resistor. It will be noted that nothing is gained by going above 100,000 ohms and that the amplifications will be about 50 per cent. more using 100,000 ohms over and above that obtained using 20,000 ohms.

The complete wiring diagram is shown in Fig. 5. If the parts are assembled as shown in the photograph, no difficulty should be found in following the wiring diagram. It is advisable to use No. 14 tinned copper bus wire covered with spaghetti, both for the sake of neatness and efficiency in operation.

The connections to the Dubilier micadons

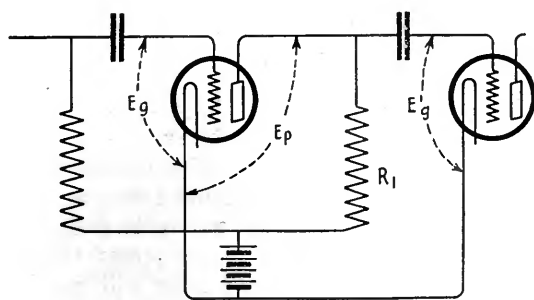

FIG. 4

How the coupling resistor is connected. The drawing shows the circuits involved in the impedance balancing between input and output of tubes in cascade for audio-frequency amplification

are shown soldered in the photograph. A half inch 3/8 machine screw is inserted with its head supporting the tube and a nut run up for the purpose of clamping the flexible wire terminal of the resistor and grasping the screw tightly. The sketch shown in Fig. 6 will make this construction clear. Fig. 7

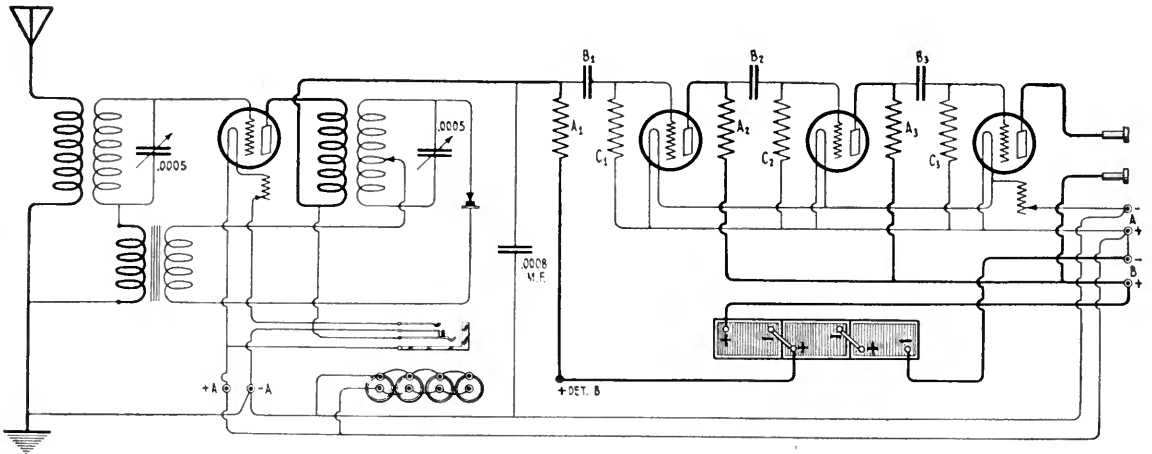

FIG. 5

Complete wiring diagram of the 3-stage resistance coupled audio amplifier connected to the RADIO BROADCAST "Knock-Out One-Tube Reflex" set

shows how to connect the Lavite resistor. Considerable skill is necessary to do this successfully without damaging the condenser and unless the constructor has had considerable experience with the soldering iron, it will be advisable to clamp the wires tightly to the condensers by inserting  $\frac{1}{2}$  inch  $\frac{6}{32}$  machine screws into the eyelets of the condensers.

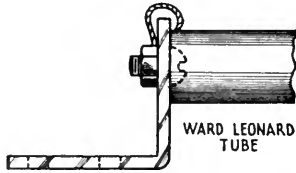

FIG. 6

How the lead from the Ward-Leonard resistance tube is fastened to the connector

ohm resistors are in series with vacuum tube plates, in the case of the Lavite tubes, approximately 20 per cent. of the available B battery voltage drop will take place across the resistor. Thus, the vacuum tube will get but

B BATTERY VOLTAGE

ON ACCOUNT of the fact that the 100,000

80 per cent. of the voltage of the connected B battery. For most efficient results, therefore, at least twice the B battery voltage normally used should be employed with the resistance coupled amplifier. Forty-five to ninety volts should be connected to the detector tube and from ninety to one hundred eighty for the amplifier tubes for loud speaker operation.

If moulded tube sockets are used manufactured from some of the compounds that are not as good insulators as others, it may be found that on weak signals, the grid leaks are apparently unnecessary. On strong signals, however, the tubes will "block" unless the grid leaks are placed in the circuit.

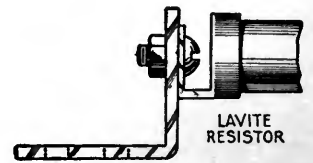

FIG. 7

How the Lavite resistor is connected

*In the June RADIO BROADCAST will appear a complete how-to-make-it article by Zeb Bouck showing how to incorporate the 3-stage resistance coupled amplifier with the "Knock-out One-Tube Reflex"*

# Man-Made Static

Definite Instructions on How to Eliminate Outside Local Interference with Radio Receivers

BY A. F. VAN DYCK

Engineer, Technical Division, Radio Corporation of America

## PART II

IN THE preceding article a general discussion of "man-made static," or inductive interference, was given, including a list of such causes of this interference as are commonly reported. We will now take up these causes individually, to show how each originates and how each can be remedied.

Lightning arrestors used on power lines are not troublesome ordinarily, because they produce interference only when voltage is discharging through them, which is seldom, or when they are being "charged," which requires only a few seconds each day and is usually carried out at times other than broadcasting hours.

Arc lights are frequent and serious offenders.

Arc light interference is very difficult, if not impossible, to eliminate. As somebody has said, the best way to eliminate this interference is to move one's home to a neighborhood where none of these lights exist. Arc light interference is particularly troublesome because the light itself has somewhat of the nature of a spark, which sets up interference as explained in the previous article. Consequently, it is often the case that arc light interference can be eliminated only with great difficulty and very special means. Very often, however, the major part of the trouble comes from faulty insulation of the power line, or the lamp itself, because the voltage used in arc light systems is quite high and the insulation must be very good. A number of cases of arc light interference have been cured by replacing defective insulators, etc. Therefore in studying a case of arc light interference, one should make certain that faulty insulation of the line is not responsible, and that the lamp burns steadily without flickering. When this sort of power line is "leaky," the noise produced in radio receivers sounds very much like the "rolling" of a snare drum.

Transformers on power lines are not troublesome very often, because they are inherently simple in design and construction, and are ruggedly and reliably built. A number of cases of loose connections on the terminal blocks of such transformers have been reported, however. That difficulty is simple to remedy.

### *The Dealer and the Radio Owner*

*Are asked and ask—often, how is my local electrical interference to be eliminated? Here are suggestions which will show the dealer how he can help his customers get greater satisfaction from their sets, and the owner of a receiver to know where the trouble comes from, when there is trouble.*

*Mr. Van Dyck has a simple remedy for every interference ill the broadcast listener will encounter.—THE EDITOR.*

### TELEPHONE LINES AND RINGERS

TELEPHONE and telegraph lines do not often cause trouble because of faulty insulation, because they do not carry much voltage so that even if the insulation of the line becomes faulty no sparking is produced. However, if a telephone line or cable is so located

that near-by power circuits induce considerable voltage in it, faulty insulation of the telephone line permits sparking of the voltage it receives from the power line. In one case of this sort, a telephone cable was located underground in a street which passed under an electric railroad. The heavy ground currents from the railroad set up electrolysis on the lead-sheathed telephone cable and finally ate through the lead and into the telephone wires. This action was possible whenever the cable became wet, as it did after every rainfall. For nearly one year, radio receivers in this neighborhood experienced bad inductive interference after every rain. The source was not found until the cable had been so badly damaged as to interrupt the telephone service, after which it was repaired by the telephone company, which of course eliminated the radio interference.

It was said above that telephone and telegraph lines do not often cause trouble because of faulty insulation. They do cause trouble often, however, because of the kind of currents used. It is reported very frequently that telephone ringing machines cause interference. Usually the ringers which inter-

There are the hand operated type, which is common in small communities. This interference is readily recognized by its intermittent nature, and the use of call signals. When the ringing generator is motor driven and causes interference it is of course continuous, and not intermittent as is the case with hand operated ringing generators. It is particularly severe in the immediate neighborhood of the telephone exchange. Interference from telephone ringers can be eliminated usually, and always greatly reduced, by the use of a proper filter between the ringing keys and the machine. Such a device can be installed by any telephone electrician, and usually is arranged as shown in Fig. 1. This arrangement is effective in preventing interference, although it does not affect the low frequency currents used for ringing, because it prevents the high frequency currents, which also are generated by the ringing machine, from going out on the lines.

#### POWER COMPANIES COÖPERATE

IT IS interesting, and encouraging, to know that power companies are becoming interested in the interference problem to an increasing extent. Some companies are training men to locate faults causing radio interference. One company in the Middle West, has for several months past had a radio crew which is on duty nightly, and which responds to interference calls from any part of the city. This crew is equipped with a direction finding radio set mounted in an automobile, with which it is usually

able to locate sources of interference quickly. A night spent on the job with this crew is an exciting experience, although if the night is one with the thermometer shrinking out of sight, the excitement is not unmixed with tingles of another sort.

Those power companies which are most progressive in keeping their lines free from interference radiation are those which have realized that the

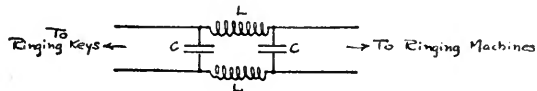

FIG. 1

How to connect a filter to prevent interference from telephone ringing systems. L is a "etard" coil (# 5AA Western Electric, or its equivalent) and C is a condenser of 8 mfd.

wide-spread use of radio has helped their business materially, and as a result, they are doing what they can to help radio, knowing that the better radio reception conditions are in the territory they serve, the greater the electrical energy they are likely to sell. It has been observed that a neighborhood consumes markedly more electrical energy as soon as radio receivers become common in it. This is readily explained by the fact that the members of households equipped with radio sets stay more at home in the evenings, and also stay up later. There is many a home where the "midnight electricity" has burned nearly every night since radio entered in. Likewise the use of power to charge storage batteries has been a considerable item. Since this extra power is used at a time when other demands are light, it is a most desirable sort of load, and power companies which have appreciated this new factor are actively coöperating in reducing interference with radio reception.

#### ELECTRIC PRECIPITATORS

MANY cases of interference have been caused by an electric device, the precipitator, although these installations are not very common. The electric precipitator is used to prevent smoke or noxious fumes or material from leaving chimneys. It operates by establishing a highly charged electric field inside the chimney, of such

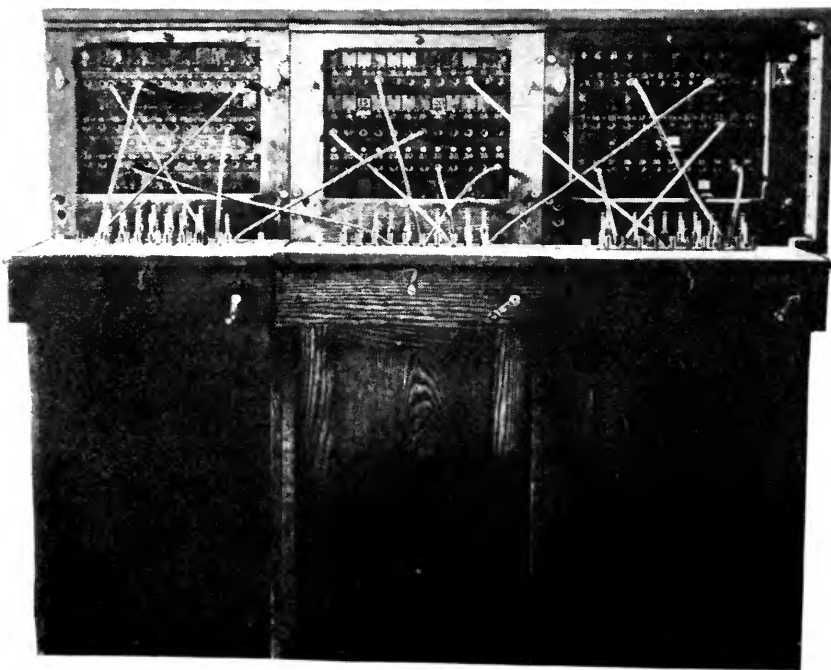

A SMALL TELEPHONE EXCHANGE  
Showing the hand ringers which may intermittently set up interference to radio listeners

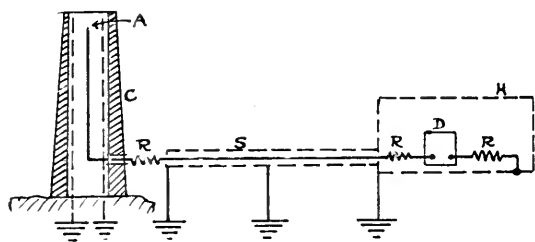

FIG. 2

How to eliminate interference from an electric precipitator. A, grounded wire which must extend above the central high tension wires; C, the chimney; R, resistances of 2,000 to 5,000 ohms; S, screen around high tension wires; D, rectifier; H, screen around rectifier, transformer, etc.

a nature and direction that particles going up the chimney are charged and driven against the walls where they stick. After a sufficient deposit has been created, it is removed in some suitable manner.

Precipitators have been used in concrete manufacturing plants, chemical plants, incinerating plants, as well as in ordinary factories where coal smoke created a nuisance. In many cases, the precipitator does valuable work in preventing actual damage to surrounding vegetable and animal life.

Precipitators cause interference for the reason that the high voltage used in their operation is obtained from an electrical device called a rectifier, which may generate high frequency alternating currents as well as the direct current which the precipitators need. The high frequency currents are not useful to the precipitator and may be eliminated without affecting its operation. If the design of the precipitator is so arranged that the distance between the rectifier and the chimney is only a few feet, there is usually no trouble.

But if the rectifier is separated from the chimney, the wire which joins them forms a good antenna which will radiate waves. This wire also runs up the chimney, but here it usually can not radiate, because there are other wires or metal surfaces surrounding it and connected to the ground. Radiation from the precipitator system and consequent interference with radio reception can be eliminated by placing a grounded mesh screen around the rectifier and the wire to the chimney. If screening of the various parts is impracticable, damping resistances can be inserted which will prevent the high frequency currents from getting to parts of the circuit from which they can radiate

seriously. A little experimentation may be necessary, but it should always be possible to make interference from a precipitator negligible at distances greater than a few score yards from the installation. The diagram given (Fig. 2) shows proper connections for an installation of the worst sort, that is, one where the rectifier and the chimney are separated by a considerable distance.

Electric signs of the flashing kind are not troublesome often, partly because they are not common in residential neighborhoods. Interference from this source can be minimized by keeping the switching contacts in good condition and by connecting resistances of the proper size across the contacts. It can be eliminated entirely by putting choke coils in every wire going into the switch, including the main power lines. The choke coils must be capable of carrying the current which will pass through them.

#### HOUSEHOLD APPLIANCES

**M**OST household appliances are used only intermittently and for short periods. Interference is often experienced in the same house where the appliances are used, but rarely extends farther, if the appliances are in good condition. Devices involving small motors may need to have the motor brushes and commutators cleaned and cared for. Bad contacts in plugs, sockets, switches, etc., are much more apt to give trouble, particularly in flat-irons and other heating devices. In heating appliances the current used is relatively large and the service conditions are more severe due to the heat, so that bad contacts are quite likely to develop.

Interference from door bells and elevator calls can be prevented by connecting a large condenser (2 mfd. capacitance) across the device, or by connect-

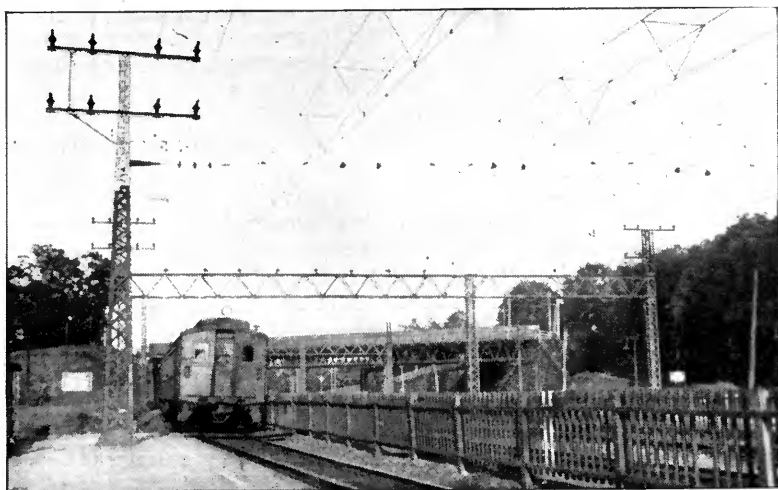

#### HIGH TENSION WIRES

Like these cause frequent disturbance to the near by broadcast listener. Radio antennas at right angles to power wires such as these will pick up the least interference

ing a "honeycomb" coil in series with each wire to it. In some cases, both condenser and coils may be necessary. In every case, the condenser or coil must be placed as close to the bell as possible.

Violet ray outfits are serious disturbers of the peace, particularly since it seems to be popular practice among owners to use them just before going to their beds, which is about the middle of the evening in the schedule of the radio fan. Neighborly requests to utilize the machines in non-broadcasting hours are usually effective. If not, the interference can be stopped by inserting choke coils in the power lines to the machine, one in each line. These may be made by winding three layers of No. 18 bell wire on a three inch tube with winding about six inches long. Then two condensers each having 1 mfd. capacity should be connected across the terminals of the machine and the mid-point connection grounded. This has been effective in several installations.

It should be understood that the method of inserting choke coils in the lines, which has been mentioned several times, requires the use of parts properly approved by the Board of Fire Underwriters as with all devices connected to the power lines in a house.

#### HOW TO FIX MISCELLANEOUS INTERFERENCE

**A**MONG the miscellaneous interference sources listed in last month's article, the X-ray machine is the worst. They are not very common, however. These machines radiate quite powerfully, and the radiations are sent out chiefly from the power lines from which is taken the power to run them. To prevent interference from X-ray machines, the method described for violet ray machines should be used. The size of wire used in the choke coils must be quite large enough to carry the current which the X-ray machine draws. Also additional condensers of the same size and method of connection may be placed across the power lines where they enter the two choke coils. If it is desired to have a radio receiver close to an X-ray outfit, it will also be necessary, probably to enclose the X-ray apparatus in a grounded metal cabinet.

Gas engines with electric ignition often give interference. The farm lighting plant is a common example of this. Part of this interference comes from the high tension leads and sparks at the spark plugs, and part comes from the contactor in the low

voltage circuit. The radiation is usually at very short waves and is highly damped in character. Both of these factors make it difficult for the ordinary receiver to tune out the interference. The remedy is to replace *all* the ignition wiring with lead covered cable, the lead coverings being well grounded at frequent intervals and particularly at its ends. Of course if lead covered cable is used for the high tension wires, the insulation between the lead and the wire must be very good to stand the voltage. Sometimes heavy rubber insulated cable, wrapped with tin foil which is grounded, can be used. Occasionally it will be necessary to insert choke coils in the spark plug leads, right at the spark plugs. Such coils may be made with about 200 turns of No. 36 double silk covered wire wound on a two-inch tube. These coils may have to be enclosed in a grounded metal box.

The ignition system of automobiles radiates short waves in the same manner as that of the stationary gas engines described above. These can be heard only a short distance ordinarily, such as when the automobile is almost directly under an outdoor antenna.

Every broadcast listener should assist as much as he can, to locate and eliminate unnecessary inductive interference. Every listener should realize that broadcasting is only one of the many electric applications upon which we have come to depend. It is also the latest, and as such it must do its share in accommodating itself to the others. It is quite unreasonable to expect that every power line, every motor, every electric device, shall operate at all times so as not to produce interference with the weak radio voltage received from some relatively small station hundreds of miles away. The broadcast listener must do his share by working with signals which are strong enough to dominate a reasonable strength of waves from other sources. The romance of reaching out to great distances of reception is apt to cause any one to forget that motors and other things must continue to operate. As broadcasting continues to develop, it will be found that several features will be improved, including better ratios of signal strength to strength of unavoidable interferences. It may be necessary once in a while to have an "Inductive Interference Clean-up Week," but we can reasonably expect that interference troubles will decrease to a satisfactory degree, as radio takes, and is accorded, its proper place among the electrical services of mankind.





# Regeneration Without the Squeal

By BOWDEN WASHINGTON

Chief Engineer, Cutting and Washington Radio Corporation

HERE is some reason for each really new radio circuit, though many so-called new circuits seem to be brought out largely because some dealer is over-stocked in variometers, variable grid leaks or some other part, and therefore has his "radio expert" design a marvelous new circuit to help him get rid of them.

## WHAT CAUSES RECEIVING DIFFICULTIES

IN RADIO receiving we are subject to four major kinds of interference. First, that from spark transmitters aboard ship. This is only severe along our seaboard and will be rapidly cured by the replacement of the obsolete spark type with modern continuous wave or tonic train (I. C. W.) tube sets.

Second, we have interference from near by broadcasting stations. This probably can be solved with sufficiently selective receivers. The writer has a receiver at his house (this receiver by the way is not a super-heterodyne) which is only three blocks from WLAG, a typical 500-watt Western Electric Station, tuned to 417 meters, and has no difficulty whatever in receiving distant broadcast from 380 meters down and 441 meters up, with absolutely no interference. This same receiver at a distance of fifteen miles from WLAG experiences no difficulty on distant stations at 411 while WLAG is operating on 417, so I think it can be said that this interference is no longer a fundamental difficulty.

Third, we have static, which, of course, can be very bad, but static is intermittent, and troubles us very little in the winter months and probably eventually will be largely eliminated.

Fourth, and worst, we have interference

from transmitting or radiating receivers. The reason I say "worst" is that probably there is no solution for this malignant interference but the discontinuance of the use of this type.

## WHAT HAPPENS—WHEN YOU LISTEN WHILE A RADIATING RECEIVER IS "ON"

IT IS impossible to evolve a principle which will eliminate noises received from single-circuit regenerative and similar offending receivers, because the noises caused by these receivers are identical electrically to the noises emanating from the broadcasting station which you are trying to listen to when disturbed by them. Everyone is familiar probably with the sound phenomenon known as beats. We know it best perhaps in organ music. If one organ pipe is sending out 300 pulsations a second, and another 340, the two will alternately add and detract from one another forty times a second, and you will hear, apart from the notes of the two pipes, a 40 "cycle" note. A broadcasting station operates on very much the same principle. For instance, we will say that the station is operating on 300 meters. When the transmitter is running and the studio is quiet, a million cycles a second will be sent out in the ether. When then a soprano sings a fairly high note into the microphone, the station continues to send out its million-cycle wave, and in addition to this "carrier wave" two waves called "side bands," one at a mil-

lion plus a thousand cycles, and the other at a million minus a thousand cycles which when they arrive at your detector produce a thousand impulses a second combined with the carrier wave; and you hear these thousand pulses or the note which the soprano is singing. If a single-circuit oscillating receiver down the block is hunting

As far back as 1922, this magazine raised a protest against the use of "squealing" receivers. And since that time, there have been a number of progressive and broad-minded manufacturers who have done their best to develop efficient, sensitive receivers to take the place of the ether agitators commonly called "bloopers." Dr. Bowden Washington reviews very ably, we think, the entire complicated situation and describes a new receiver his company has designed. This visible co-operation of manufacturers shows much potential good for the industry.

—THE EDITOR.

for that station, and oscillates at a million plus or minus a thousand cycles, it sends out a wave identical to one of the two side bands produced at the broadcasting station by the soprano. This, combined with the carrier wave of the broadcasting station, produces exactly the same result in your receiving set as the carrier wave plus the station side band. The detector would have to have a brain to be allowed to conclude that no soprano would be allowed to hold this squeal for such a long period, or that the squeal did not belong to the air being sung, and to cut it out. A brain, of course, is something that no mechanical or electrical device can possibly have.

#### LEGISLATION ISN'T THE ANSWER

I DO not believe legislation against this receiver or circuit is the answer. We are too prone in this country to feel that all that is necessary to remedy any situation is to pass a law "regulating" it. It would be easy, of course, to prohibit the manufacture of radiating receivers by the reputable companies en-

gaged in the business, but I believe that fully 70 per cent. of the offending receivers in use to-day are of home manufacture. Herein the difficulty lies, for though the single-circuit regenerator is very unselective and usually unable to respond to anything but the loudest signal present, it will certainly give the greatest distance and volume at the minimum expenditure of time and money. Almost everyone knows how to make this apparatus, and it seems to me that it would require a tremendous enforcement personnel to prevent its home manufacture and use.

It would be hard to use the radio compass on the intermittent noises they produce. Owing to the fact that these sets are almost as efficient on a poor antenna as on a good one, a moderate sized indoor antenna can be used with perfect satisfaction, which makes them difficult to find. It is impossible to search private houses without a warrant, and at least moderate grounds for search must be at hand to obtain a warrant. It would be impossible, or at least extremely difficult, to teach through any educational campaign the users

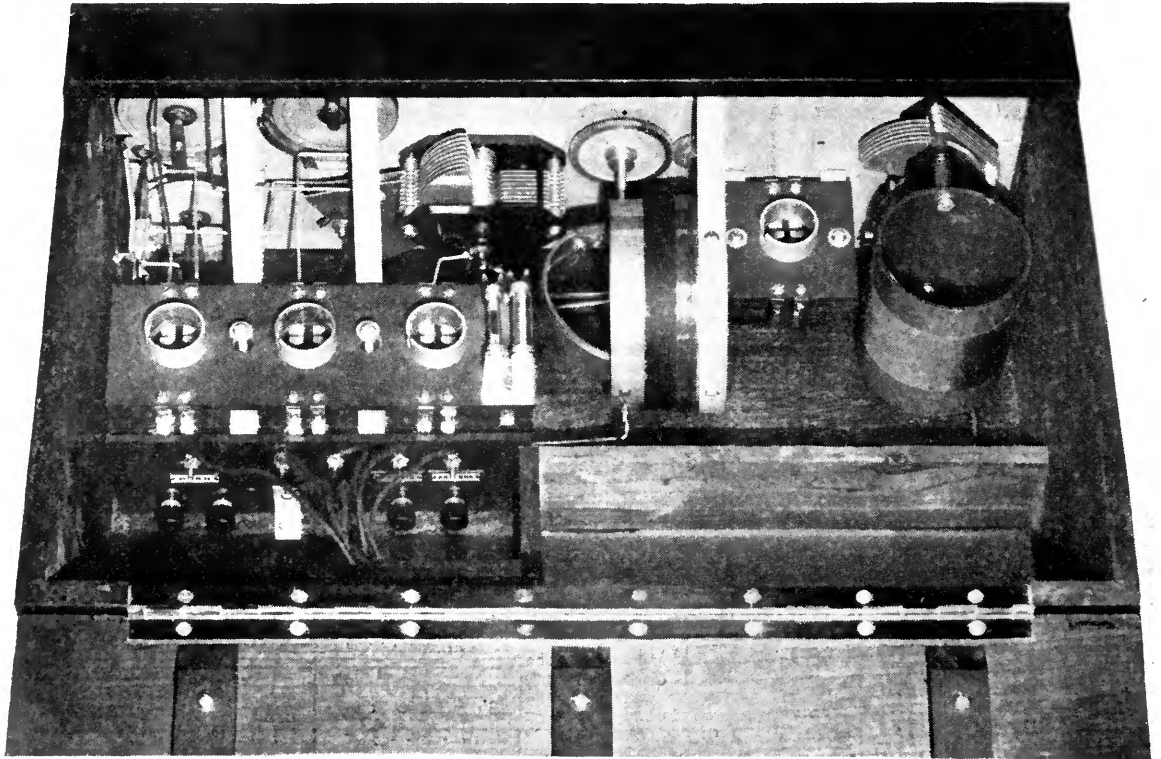

THE "WORKS"

Showing the excellent construction of the sensitive, non-radiating receiver designed by Mr. Washington

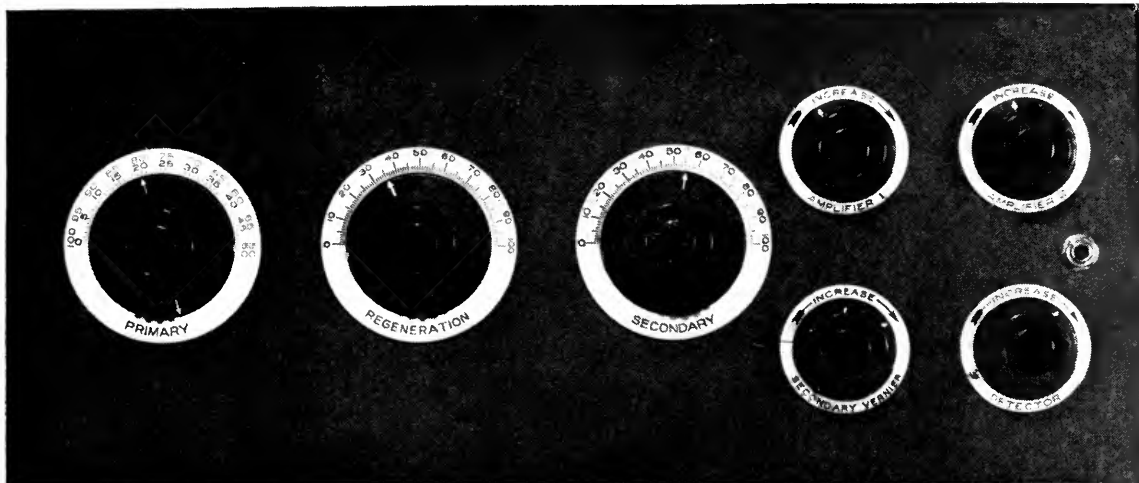

THE FRONT PANEL VIEW OF THE SET  
But two controls are generally used in tuning

of these receivers how to operate them in such a manner as not to produce interference with their neighbors; because this form of operation would mean a careful and painstaking use of both hands in keeping the regeneration control at all times just below the oscillating point while the wavelength control was operated up and down the scale in searching for distant stations. A much simpler method of finding distant stations, and that in general use, is to cause the receiver to oscillate and move the wavelength control until the operator hears a loud squeal. Incidentally your neighbors and perhaps erstwhile friends hear it, too, worse luck.

#### AN AGGRESSIVE PUBLIC OPINION IS THE ANSWER

THE only possible solution, to my mind, is so to indoctrinate the public, through magazines, newspapers and broadcasting station publicity, in the harm that this type of receiver does, and in the selfishness, unconscious or otherwise, of its owner, that public opinion and a sense of fair play will rule them out of existence.

Users of these receivers should also be made to realize that on account of the inability of this type to select anything but local broadcasting when near-by stations are running, the owners are missing a great deal of the real enjoyment of radio, i. e., being able to select almost any program at nearly any time.

To the average reader, it may seem that my convictions in this matter are rather extreme. But, I certainly believe that the "transmit-

ting" evil, if allowed to continue, will result in less interest in broadcasting as well as agitation for legislative action.

I think it is generally admitted that the millions of squeals sent out onto the air every night will, in time, lessen the enthusiasm of the listener-in. When the listener-in begins to become disinterested, broadcasting will slacken. Naturally either of two things must result—the squeals must decrease or broadcasting will.

We who are so vitally interested in radio—by "we" I mean the general public—cannot afford to see radio slump, and we will not allow it to slump. Radio is already a necessary and solid institution. The American people never have and never will do without something it likes, merely because of difficulties. Therefore, I do not hesitate to predict that the "transmitting" receiver will perhaps this year become obsolete.

The trouble is not with regeneration as a principle, in fact it is an extremely useful principle, increasing the effectiveness of the vacuum tube enormously. Regeneration applied with extreme care and with very delicate apparatus in the laboratory can make response from all signals weak and strong practically equal. The trouble is that all conventional single-circuit regenerative receivers, and to a considerably lesser degree the two-circuit type, can transmit because the tube which in these circuits is directly connected or coupled to the antenna, may be made to oscillate.

## HOW DESIGNERS HAVE AVOIDED REGENERATION

THE neutrodyne was probably the first adequately sensitive receiver which did not to a greater or less degree transmit, but the neutrodyne, as no regeneration is employed, is somewhat wasteful on tubes. By this, I mean that a five-tube neutrodyne does not get anything like the volume from its five tubes that it would, if regeneration could be employed in the three radio-frequency tubes.

Regeneration is also a tremendous aid to selectivity. It can be regarded as an application of negative resistance. As regeneration is increased, the effective resistance of the circuit becomes less and less until it reaches zero. If pushed to, or beyond, this point, oscillation occurs.

You all know that a low resistance circuit is a "sharp" or selective circuit. The neutrodyne owes its selectivity not to the individual selectivity of each circuit, but to what is called the concomitant selectivity of the three circuits involved. For instance, if each circuit reduces interference to 10 per cent. it will be 10 per cent. in the first circuit, 1 per cent. in the second and  $\frac{1}{10}$  of 1 per cent. in the third. Approximately the same selectivity can be obtained in fewer circuits by making them of lower effective resistance by using regeneration.

There are several types of receivers which

manufacturers have developed to escape regeneration. The Teledyne, which is illustrated in the accompanying photographs is a recent contribution in this line. The Teledyne makes use of full regeneration in the detector, but even if the detector is allowed to oscillate, these oscillations cannot be radiated because of the peculiar type of radio-frequency amplifier ahead of the detector. The Teledyne with four tubes under equal conditions seems to have somewhat more volume than the five tube neutrodyne.

The grid and filament of this radio-frequency amplifier are connected in the usual manner across the antenna tuning inductance. The plate of this tube is coupled to the detector-grid inductance, which is tuned with the usual parallel condenser. The detector is furnished with a conventional regeneration coil commonly called a "tickler." The coupling between these two tubes is such that when the detector-grid circuit is resonant, this circuit has an impedance approximately equal to the output impedance of the amplifier tube, which is the correct load for most efficient output of this tube. In this coupling position, the impedance is not of the correct inductive value to produce oscillations, so that the radio-frequency amplifier cannot itself oscillate. Its grid inductance, which is in the antenna, is at zero coupling position to the detector-grid inductance (primarily to prevent parasitic feed-

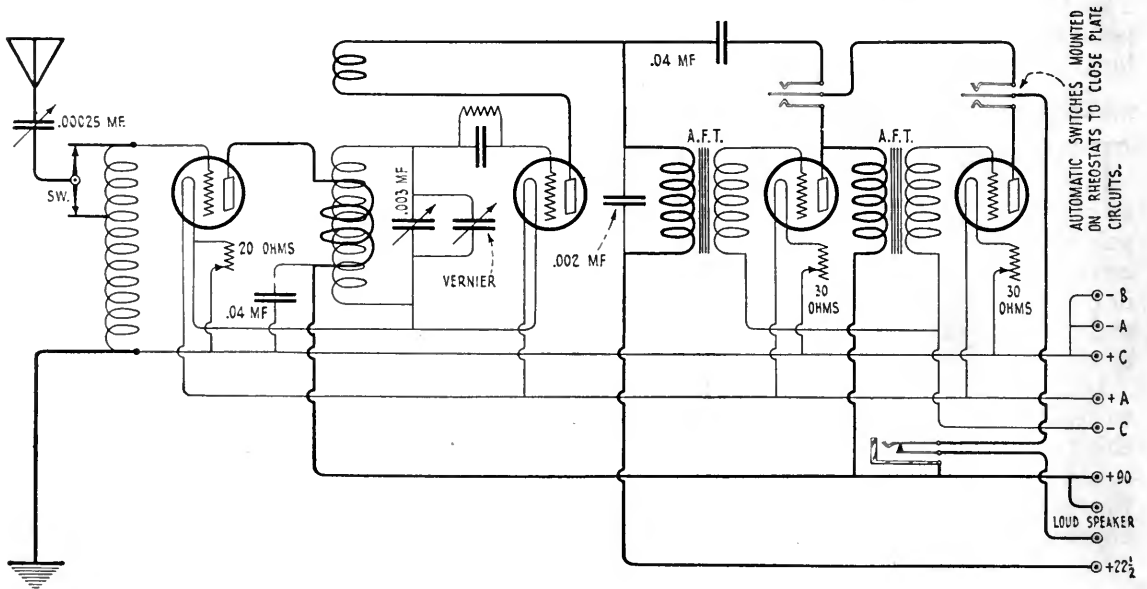

COMPLETE CIRCUIT DIAGRAM OF THE TELEDYNE RECEIVER

It uses one stage of radio-, two stages of audio-frequency amplification, and detector

back) and therefore oscillations in the detector can never reach the antenna.

Among the advantages of this circuit may be mentioned ease of handling, as there are only two major controls, one for each hand. The detector regeneration control may be left at a low value and used to increase the intensity after the signal has been found. If searching for an unknown station, the detector may be made to oscillate freely, and the primary

and secondary controls manipulated until a so-called “carrier wave whistle” is picked up, much as in the present regenerative receiver, without fear of causing annoyance to your neighbor. It will be found to have high selectivity and extremely high efficiency. It can be used effectively on a small antenna and has, I think, to a greater degree, all the advantages of the conventional regenerative receiver and none of its disadvantages.

## “As It Was in the Beginning”

A Personal Narrative of the Early Days of Wireless by One of the Few Men Who were Helping Start the Wheels Almost Before There Were the Necessary Tracks

By ROBERT H. MARRIOTT

Past President, Institute of Radio Engineers, Expert Radio Aide, Puget Sound Navy Yard, Washington

I AM going to try to tell the story of how radio began in the United States. It will not be the story of who invented radio. That question of who invented radio is a subject that people quarrel over. While I am not a Quaker, my ancestors in Maryland may have been Quakers two hundred or more years ago, and I may have a “hang over” from them that makes me desire to avoid quarrels. At any rate I am not going to claim that I or anybody else invented anything, but just try to tell how and when regular everyday wireless service started in the United States. I will call it “Wireless” because that is the name it went by in those days. And I am going to tell the story in a personal style because, in many ways, it is a personal story.

I suppose the reader wants to know just why I should write about this. Perhaps I shouldn't, but the reason I am writing about it is that I designed and supervised the construction of the instruments and stations that gave the first regular ordinary everyday radio service in our United States.

The next questions are: How did I hap-

pen to do that and what circumstances led up to it? When I entered Ohio State University in 1897, I had decided that I wanted to specialize in physics, especially on “cold light,” “X-ray,” or “Wireless.” The head professor of physics, Dr. Thomas, was just recovering, after several months, from being burned by X-rays, which was discouraging for “X-rays,” and he told me he did not think “cold light” was a field that we could do much with, so I decided on “wireless.”

Dr. Thomas, was a scientist and he tried to see that I applied myself correctly to the study of what had been written and to the performance of the experiments, which had led up to wireless as it was then. Gradually this worked up to a point where I had quite a collection of wireless apparatus that I experimented with or, one might frankly, say “played with.” As no other student was sufficiently impressed by wireless to work with me, I had to control both the transmitters and receivers by myself, therefore the longer distance work about the campus was accomplished by fixing a clock pendulum so

### *Pioneers Three*

*Are Mr. Marriott, Mr. G. W. Pickard, and Dr. De Forest in radio. They are some of the few who started in the field who are still active, twenty-four years after. Here is a well-told story of personal experience in the days when the infant radio daily astounded the natives, of whom, most scoffed and few believed. It's a good story.—THE EDITOR*

it would touch a pool of mercury closing a circuit and making the transmitter send a dot every second.

#### THE EARLIEST RADIO COMPANY

**I**N 1901, articles appeared in newspapers stating that a corporation called the American Wireless Telephone and Telegraph Company was starting into wireless on a commercial scale. That company based its right to exist on a wireless patent issued to Professor Dolbear in 1886. I wrote the company asking for a job. Much to my surprise, the president of the company wrote back and told me I could have a job if I would take it at once. I hadn't quite finished my college course but I took the job, in June, 1901.

We of the American Wireless Telephone and Telegraph Co., built stations at Galilee, Briele

and Barnegat, New Jersey, and placed a station on a vessel to report the yacht races of the *Columbia* and *Shamrock* in the fall of 1901.

Three organizations tried to report those yacht races, Marconi representatives from England, De Forest who was starting a wireless company in New Jersey, and our company, the American Wireless Telephone and Telegraph Company. Mr. Greenleaf Whittier Pickard was also with the American Company. I believe that Dr. De Forest, Mr. Pickard, and I are the only Americans who have continued actively in wireless up to the present. The others, who are living, have entered other lines of work or have retired.

Except for the brief service rendered in reporting the yacht races, those stations only served for demonstrating and experimenting as other stations had done before. They were

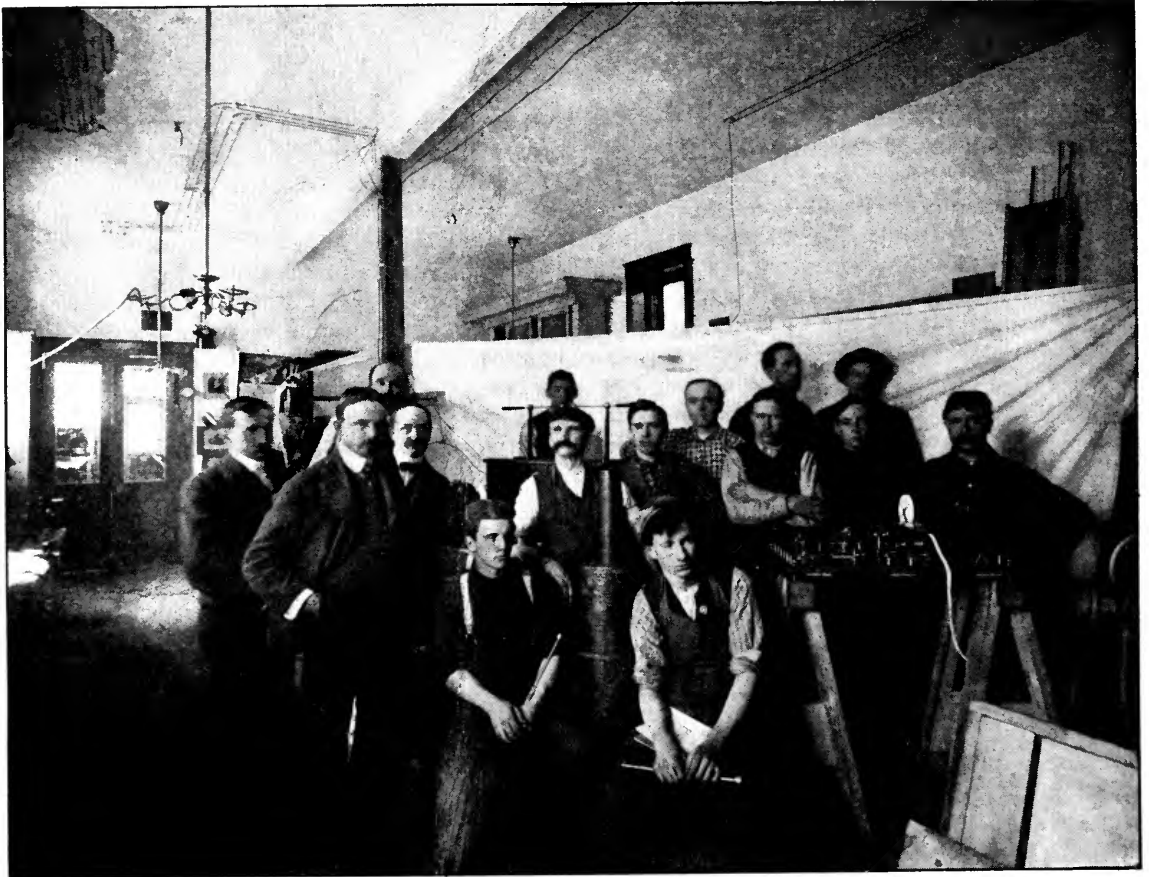

RADIO PIONEERS TWENTY-FOUR YEARS AGO

The men who built the wireless apparatus during the winter of 1901 and 1902 in the shop of the Carstarphen Electric Co., Denver, Colorado. Mr. W. P. Carstarphen is the tall bald man in the rear. Mr. G. T. Swenson who later became Mr. Marriott's assistant in the California work is the man in the checked shirt in the center. Mr. Marriott is at the left with his hand in his pocket. He says he was trying to raise a beard to look old enough for his job. He was twenty-two

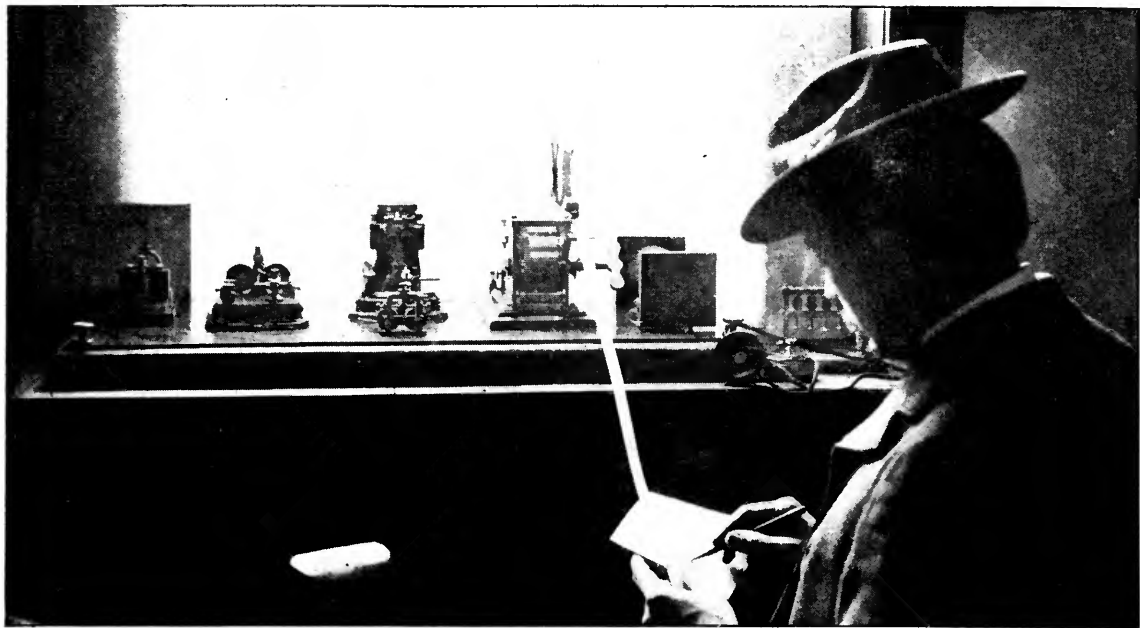

RECEIVING APPARATUS, MODEL 1902

The coherer detector, decoherer, relays, sounder, tuning transformer, and tape recorder are shown on the large board. At the right is shown a contact type detector with telephone receivers. In this contact detector, steel balls floating on mercury were brought into contact with a strip of aluminum or oxidized iron. The contact pressure was varied by screwing a thumb screw in or out of the mercury. The phones used were the adjustable-magnets, watch-case type of Stromberg-Carlson phones, rewound with fine wire (36 or 40 B&S). Note the leveling screws on the coherer receiver board; not only were these necessary but the coherers had to be very carefully made, exhausted by a mercury pump and the circuits screened by a metal case as we screen circuits now. Taken in Denver, March, 1902

not located where there was a demand for the kind of service they could render. One of the main things they demonstrated was that wireless stations should be placed where there was a demand for what they could do, if wireless was to develop as an art. Also those three companies produced the first prominent wireless interference object lesson, when they intentionally and unintentionally interfered with each other in their efforts to each beat the other at reporting the yacht races.

About the time of these races, rumors started in the American Wireless Telephone and Telegraph Company that those who were working for the American Company would get opportunities to become chief engineers of subsidiary companies. According to the story, the promoters of the American Company had formed that company as a parent company and had parcelled out the United States and its possessions to a number of subsidiary organizations. The understanding was that the parent company was to furnish patent protection and instruments for considerations, and trained men for the subsidiary groups to hire as chief engineers.

By the subsidiary arrangement, the Pacific Wireless Telephone and Telegraph Company and the Continental Wireless Telephone and Telegraph Company had the Western States, Pacific States, and Alaska. Practically, they were one company because the two companies had the same men for officers. They seemed to me to have a territory where wireless might be immediately useful. After a few weeks of talks, telegrams, and letters while I was supervising the building of a station at Barnegat, New Jersey, I joined to the Pacific and Continental Wireless Telephone and Telegraph Companies and went to their headquarters in Denver.

The parent company had not lived up to its agreement to supply instruments, and from what I had seen of the officers of the parent company I did not believe they would ever supply the apparatus, so I set out to build two sets of instruments for use between Catalina Island, California, and the mainland of California. Some of the officers of the Pacific and Continental companies wanted to put the stations at Denver and Golden, Colorado, where they would have been, simply, another



case of experimental or demonstration stations and moreover they would have been in competition with both wire telegraph and wire telephone. I believe those officers never did agree to the California plan, however, as the

larger place, and changed the name to the Carstarphen Electric Co. I furnished the designs and supervision and the employees of those companies built the apparatus.

#### WHAT APPARATUS WE HAD

THE induction coil, vibrating interrupters, and the coherer detectors used in wireless sets in those days were not so bad for demonstration purposes, but they were obviously unreliable for giving public telegraph service. The vibrators would stick and stop. The coherers wouldn't work when they should, and would work overtime when they shouldn't, and the tape recorder made the same dots for static that it made for signals. So I designed an interrupter consisting of a motor driven disc with two insulating segments and two brushes pressing against it. That interrupter was effective and more reliable. We built coherer receivers, but in the meantime I built and tried out numerous contact point detectors with telephone receivers for sound reception. In those receivers static did not make the same sound that signals made. I bought watch case receivers like the "Hello girls" wore, rewound them with fine wire and mounted two on one head band like head sets of to-day.

I hired one of Mr. Carstarphen's men, Mr. G. T. Swenson, as an assistant and in April, 1902, we took the completed instruments to California and started construction of a station above Avalon on the Island and another at White's Point on the mainland near San Pedro and about twenty-five miles from Avalon. White's Point was the nearest point and located there was a dance pavilion which we made into a station. At Avalon we had to blast off part of the hill and build a station house.

#### THE FIRST STATION

A REAL, practical and continuous demand existed for telegraphic communication between Avalon, Santa Catalina Island, and the mainland of California. The demand for a service that would be more suitable than carrier pigeons and two or three daily boats had existed for some time and the needs for such service were growing. Not only was the demand there but the interfering static was more pacific on that coast than on the Atlantic Coast of the United States, and the distance was short enough for day-and-night, all-the-year wireless service. In addition to those

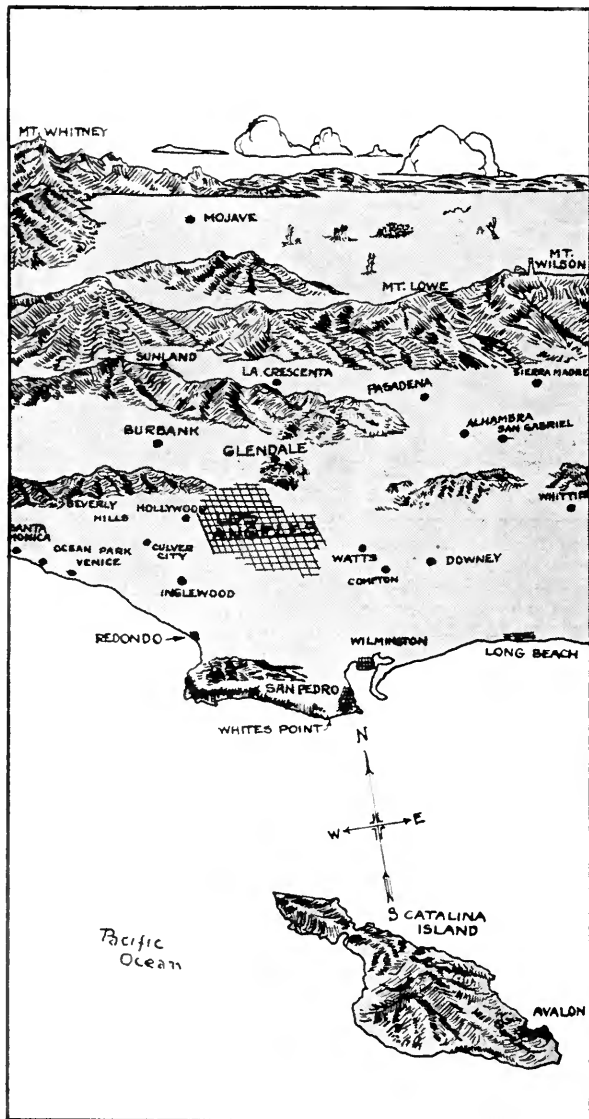

BIRD'S EYE SKETCH OF CATALINA AND THE ADJACENT MAINLAND OF CALIFORNIA

saying is now "We got away with" the California plan.

Work on the wireless instruments was started in November, 1901, in a little Denver shop belonging to Messrs. Carstarphen and Wallace. By the first of the year 1902, Mr. W. P. Carstarphen had interested capital, moved to a

helpful conditions, the wireless apparatus we installed was simple. That apparatus did not contain the erratic coherer or induction coil vibrator and any part or material in it could be bought in the open markets of the United States and repairs could be made by almost any studious electrician. Those are probably the main reasons why wireless became a successful everyday public service between Catalina and the mainland.

Wireless operators did not exist in those days. There were plenty who could receive the signals made by a wire telegraph sounder or read the tape marks as produced with the coherer type of wireless receiver, but they had not learned to recognize the same dots and dashes in the form of short and long buzzes in telephone receivers. The first few messages were sent and received by Mr. Swenson and me although neither of us were operators. To send, we picked the letters out of a printed American Morse code, and to receive we made a mark with a pencil when we heard a short buzz and other marks or left spaces in proportion to the length of buzzes and spaces and when the sending stopped we compared those marks to a copy of the Morse code and wrote the corresponding letters above the combinations of dots and dashes. Many of the subsequent messages were received in almost that painfully slow way until real operators retrained their minds to give the same translation to buzzes that they had been giving to sounder clicks. After a few operators had set the example, others lost the it-can't-be-done feeling, and learned to receive rapidly.

The transmitter dynamo was driven by a gasoline engine having a spark ignition system and those sparks interfered with receiving. Sometimes, the gas engine had to be stopped to receive. Shutting down to receive and

starting up the temperamental gas engine to transmit, combined with detector adjusting and undeveloped receiving ability made the early service very slow as compared to a good wire line.

WHEN THE TROUBLE STARTED

THE majority of the public that paid any attention to our efforts during the building and testing of the stations, seemed to be divided in its opinions of wireless experts. They seemed to think the wireless experts were supernatural, crazy, or crooked. These three classes of opinions manifested themselves in ways which were sometimes amusing and sometimes painful to the expert. Where the opinion overrated us, it sometimes caused some embarrassment. For example, while we were developing the sound receiving method, a number of sensitive microphones had been made and the Avalon station had been provided with concrete piers anchored in rock, and a sound proof booth, for delicate microphonic work. Before

the station was completed, a visitor asked some question about a carbon-steel microphone that was resting on a piece of paper on a pier and while the microphone was being explained and demonstrated, the visitor wore the telephone receivers attached to it and a fly lit on the paper and walked. The visitor saw and heard the fly light and heard his foot steps in the telephone receiver. The visitor was startled and amazed almost to the point of dragging the microphone off of the pier. And I was equally startled and amazed the next day when I read of myself as a scientific wizard of infinite ability occupied on the hill above Avalon with instruments so sensitive that I could hear flies walk in San Pedro. As the distance was twenty five miles, that was an excellent yarn for those

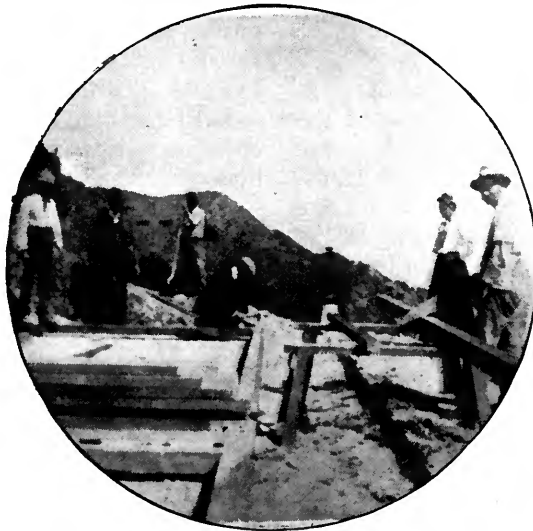

AN HISTORIC RADIO GROUP

R. H. Marriott driving the first nail in the first wireless station at Avalon, Santa Catalina Island, May 12th, 1902. This was the first regular everyday wireless service station in the United States

days although it could be done with radio-phones and receivers of to-day.

At Catalina was a resident who had known and admired my grandfather. He had admired my grandfather so much that he did not want to see the family name dragged in the mire by me. From his remarks I gathered that he with others were convinced that wireless was all a fake and he was very much afraid that my notably honest and wise grandfather had failed to leave one or both of those notable characteristics to this grandson. He was sincere even to the extent of intimating he would pay my fare out of the country if I was as weak in my finances as I appeared to be weak in honesty or wisdom.

The 1902 Fourth of July fireworks at Avalon were novel in that they included the burning of a steamship. The old S. S. *Hermosa* which had served Avalon for years, with transportation and communication, was set on fire and towed around and back and forth in the outer harbor while the band played and rockets ascended from the top of Sugar Loaf Rock, and the wireless station contributed an illuminated star at the top of the wireless mast on the hill above Sugar Loaf. The star was made as big and bright as we could make it by using all the electric power our dynamo would

deliver. That noticeable brilliancy on our part had an unexpected effect.

#### THE FIRST PACIFIC COAST MESSAGE

ON JULY ninth I received the first message at Avalon and all it said was "Do you get me." It was answered in the affirmative, but the answer was not received. Mr. Swenson on the mainland had started sending signals to me on June 28th; however, in trying out the various receivers I had not tried to translate what he said, if he did say anything, until I picked the kind of detector that seemed to be the most serviceable. That detector proved to be a contact between a polished steel tip and an oxidized iron plate. The first plate I made was from a hack saw blade, but I found I could do better by burning the surface off a piece of tin can using a blow torch and a little water and then a little oil on the oxidized surface. To get fine adjustment I needed a well made steady screw with fine threads and a large dial. The spherometers I had used in college to measure the curvature of lenses were the first thing I thought of, so I went to Los Angeles and bought some and Mr. Swenson made them into detectors that were used for several years.

Adjustments at the two stations followed and the exchanging of test messages began. The statement that test messages were being exchanged brought forth a chorus from "Doubting Thomas." A few days later Jeffries and Fitzsimmons fought in San Francisco and as we wanted early returns and wanted to convince doubters, we arranged to wireless the returns across to Avalon.

"EARS THEY HAVE AND  
HEAR NOT"

THE fight returns were laboriously received by me on the hill above Avalon about midnight and written out and taken down to town and posted. Those who were up read the

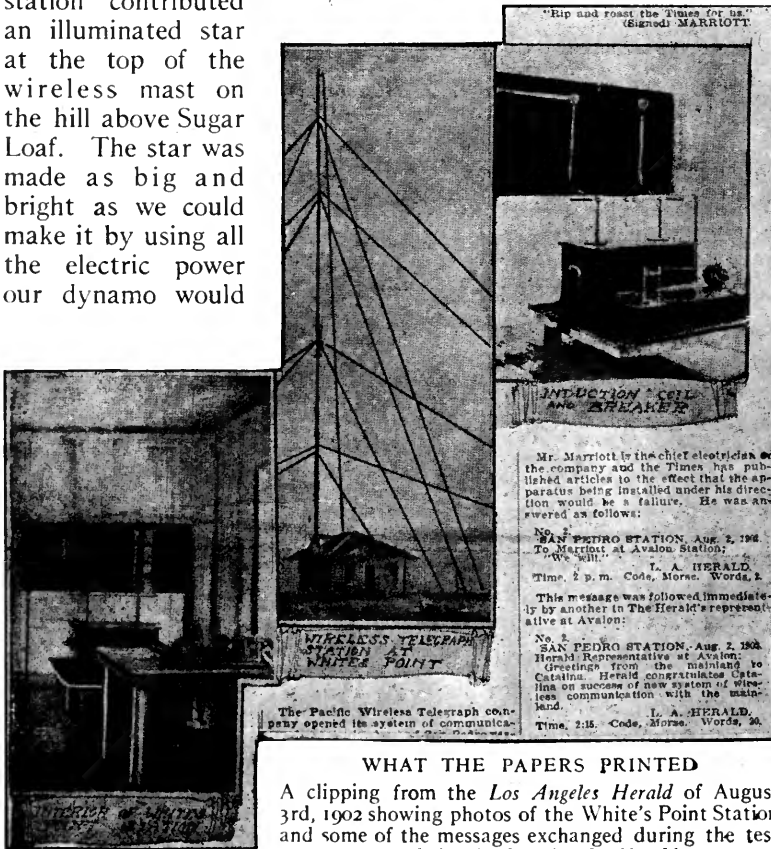

#### WHAT THE PAPERS PRINTED

A clipping from the *Los Angeles Herald* of August 3rd, 1902 showing photos of the White's Point Station and some of the messages exchanged during the test made by the *Los Angeles Herald*

bulletin but did not seem to be inclined to pay any bets on the strength of what it said. However, I was happy because I knew the papers would verify my report next day. But I had not studied psychology sufficiently for that situation. The verification by the newspapers resulted in a large collection of stories as to how the news had been received, in every way but by wireless. The knocking was epidemic, for nearly everybody broke out with verbal hammers. Carrier pigeons were credited with the feat, a man was said to have been seen bringing me the message in a small boat, good guessing and advance information were discoursed upon and then somebody bobbed up with the story that the ex-Fourth of July star illumination had been used on the mainland station mast and somebody had seen the flashing light. That yarn about the star was damnable.

The gossip and atmosphere of disbelief in the wireless was enough. However it had not stopped at that but was reflected somewhat in the more durable black and white of the newspapers. Catalina was advertized as a place where one could get scenery, climate, fish, and goats. I enjoyed the scenery, climate, fish, and hospitality of the Banning brothers who owned the Island, but lost my goat to the doubting public and similar newspapers. The *Los Angeles Times* was one of my goat getters.

"AND EYES, BUT SEE NOT"

THE *Los Angeles Herald* had been friendly and was asked to send men to both stations and exchange messages and tell the public what it found. On August second when the *Herald* notified me at Avalon that they were on the job at the mainland stations, I was tired and sore from the effects of oral and newspaper gossip so my message to the *Herald* was "Rip and Roast the *Times* for us." The *Herald* replied "We Will" and patiently sent and received messages over the comparatively slow system and wrote up their work and published it, including my message.

A daughter of a wealthy man was taken sick at Avalon and her mother obtained a specialist from Los Angeles by using the wireless. Those successive demonstrations helped to get more people to believe wireless could give service, but the thing that removed all doubts from everybody's mind was as funny as it was thorough. Two colored men got into the Metropole Hotel Bar on the Island and collected some change, a case of champagne and



HOW THE NEWS GOT FROM THEM TO US  
 First page of *The Wireless* Vol. I No. 1. A little newspaper started by the *Los Angeles Times*, March 23, 1903. It was made up from wireless dispatches received from the California mainland

some miscellaneous drinkables and departed from Avalon with the loot on the five A. M. boat. Such a get-away was old and had been safe for years because there had been no means of communication and the next boat did not go until eleven A. M. But the Bar folks knew the wireless would work and they sent a wireless message to the mainland which caused the colored men to be very surprisingly and very officially received at the pier in San Pedro. It was a spirited wireless comedy for everybody but the Negroes and it caused a laugh which shook almost all remaining stubborn disbelief out of the public.

SO WIRELESS BEGAN FOR US IN 1902  
 THAT business of putting wireless into common everyday service in the United States occurred in 1902 or ten years after Sir William

Crookes had said "Here, then, is revealed the bewildering possibility of telegraph without wires, posts, cables, or any of our present costly appliances." (*Fortnightly Review*, London: February, 1892.) He said those words while discussing the wireless experiments which Hertz had performed in 1886.

After the stations proved themselves, the newspaper reporters and others said they had not intended to belittle wireless and wireless apparatus or wireless engineers, but that they may have unconsciously done so in attacking the stock jobbers who were exaggerating what wireless could do so they might draw big commissions from the sale of doubtful stock.

Several wireless companies were selling stock and had been selling stock by saying or implying that they were about to span the oceans and continents and take all the business away from the telephone, telegraph, and cable companies. Stock salesmen were not telling the truth when they said the wireless of those days could render everyday service across the Atlantic or Pacific or could compete with wire lines. Antidote statements were a natural result, but they were equally untruthful when they had said that the wireless we had was not capable of giving everyday useful service across that twenty-five miles of ocean where there was no cable to compete with.

After a few months of everyday wireless service, the *Los Angeles Times* started a little paper called "*The Wireless*" at Avalon. The contents of that paper consisted of local news and world news as received via wireless.

#### HOW THE AVALON CIRCUIT PROGRESSED

SINCE that time, several different organizations have owned and operated and improved that wireless circuit from the mainland to the Island. During those years the island station was shifted about Avalon and the mainland station was shifted about San Pedro, Los Angeles, and Long Beach. The list of owners included the Pacific Wireless Telephone and Telegraph Company, the United Wireless Telegraph Company, the Marconi Wireless Telegraph Company of America, the U. S. Navy, and the Pacific Telephone and Telegraph Company.

The Pacific Telephone and Telegraph Company in late years (1920) made that radio circuit one which could be used for either tele-

phoning or telegraphing and they connected the mainland radio station through repeaters to the whole Bell Telephone System of the United States and they built a local Bell system on the island to serve as an inlet and outlet for the Catalina radio station. Avalon citizens were able to talk by wire to the Catalina radio station and thence by wireless to the mainland and thence by wire to Los Angeles, San Francisco, Chicago or New York. And for the purposes of further demonstration, Deal Beach on the New Jersey shore and the S. S. *Gloucester* on the Atlantic were equipped with radio phones and conversations were carried on via wire and wireless between Avalon and the *Gloucester*.



After the telephone service became a matter of course, many of the Telephone Company's customers talked fluently and freely, not realizing that they were operating a radio telephone circuit between Catalina and the mainland, and a growing number of radio operators, amateurs, and broadcast listeners tuned-in to pick up what was said over that radio telephone circuit. Some of those who used that radio telephone circuit were movie actors and people with no work to do, but with time, money, and energy to spend, therefore it is not difficult to imagine their conversations as possessing sufficiently interesting possibilities to tune-in for. To provide secrecy, the telephone company tried experiments at making the radio waves such that only their receivers were capable of changing the scrambled radio waves into intelligible speech. By this method, the telephone company might have kept the speech unintelligible to all but experts and ingenious amateurs, but there were other interfering factors. When the original radio circuit started in 1902 there were no other radio receivers or transmitters to interfere with it. As time went on, radio service circuits multiplied and produced interference, from transmitters and regenerative receivers.

#### "THE BOY GREW OLDER"

THE wireless service family had grown in twenty-one years to include service between land stations, ship stations, ships and shore, submarines, airships, aeroplanes and amateur stations and service from compass stations, fog beacon stations and broadcasting stations and besides that, the radio frequencies

and radio apparatus that had been developed for radio service had also been applied for communication over telephone, telegraph, and high and low voltage power lines. From serving dozens it had grown to serve millions.

The telephone company could not entirely avoid all of the interference even though they did carefully choose the sites for their stations and use loops, wave-traps and other selective devices. Such interferences to the wireless telegraph circuits had only been a handicap and irritation for the wireless company's operators, but in the radio telephone it handicapped and irritated the customers. And last of all and probably greatest of all, the wave-

lengths used by the telephone company were wanted for radio broadcasting.

That first wireless service circuit lived and served the public for twenty-one years. But the wireless circuit family had grown so large there is no longer any room for that first circuit. The Pacific Telephone and Telegraph Company substituted two cables for it when their radio station licenses expired on August 1, 1923, and quit using the wireless. The argument for doing this was that the cables provide more secrecy, no interference, and connect up better with the wire system and business system of the Pacific Telephone and Telegraph Company.

## Spoken Literature for Use on the Radio

By FILSON YOUNG,—London

THE literary possibilities of broadcasting seem not to have been realized yet either in England or America. Broadcasting in England began in 1920, and to-day there are something like 500,000 known users of wireless in this country, which with its dense population and large towns dotted over the country at close intervals is particularly suitable for a broadcasting covering the whole country. At present the entertainment provided by the British Broadcasting Company between the hours of 3:30 in the afternoon and 10:30 at night covers an immense variety; short talks on various non-controversial topics; first class symphony concerts, sermons, services, speeches and so forth, as well as hours specially devoted to children's and women's interests. But on the purely literary side the resources suggested by it have as yet hardly been tapped. Once a week indeed there is a "literary talk" of a few minutes, during which certain new books are referred to; a book of my own had the honor of being among the first thus to receive a broadcast review, and the effect was startling.

But just consider the possibilities attaching to the extended and imaginative use of this new and wonderful medium. The written word, although it remains, is always inferior to the spoken word in its actual power and moving influence. Things uttered with the living voice have an appeal and command an attention which in many cases would never have been achieved at all by the written word. At present the newspaper element of broadcasting is represented by brief summaries of news, weather reports and so forth; but why should brief original composition, specially designed for this end, not be added to the utterance of broadcasting? A little five-minute essay, spoken in his own voice by a well known author would have a charm and fascination for people that has evidently not yet been realized.

There is no reason, moreover, why leading articles—which are after all only brief essays in the expression of definite opinions—should not form part of the wireless repertoire; there is no reason why the expression of opinion, as represented by the old fashioned leading article, should not take a new lease of life and exert a renewed influence.

The ordinary person who reads a newspaper seldom occupies more than half an hour over it. It ought to be possible to compile a kind of miniature compendium for the purpose of broadcasting, which would represent the picked selection which the ordinary reader makes from a newspaper. Yet, instead of being read from small type printed on indifferent paper, it would be, so to speak, performed like an opera; the individual quality of each writer would be reflected in the tones of his voice.

Of course it is not every good writer who has a good voice; on the contrary, I think it is supposed to be the rule that distinguished writers are bad public speakers. That does not mean so much that they cannot read aloud well, as that their thoughts are marshaled and molded in the form of literature rather than of speech; the redundancies and repetitions and dilutions which make oratory effective are entirely foreign to the spirit of literature, which is compact, concise, and condensed. That is all the more reason why what we may call spoken literature is so suitable for broadcasting, where time is of importance and concentration is of the essence of the program. To produce an effect and a result in a brief utterance is infinitely more within the power of literature than it is of oratory. In America particularly, I should expect this gift to be developed and if American broadcasting is as it is in England I shall expect to hear of a development of my idea before long across the Atlantic.

(Reprinted by Courtesy of *New York Times Book Review*.)



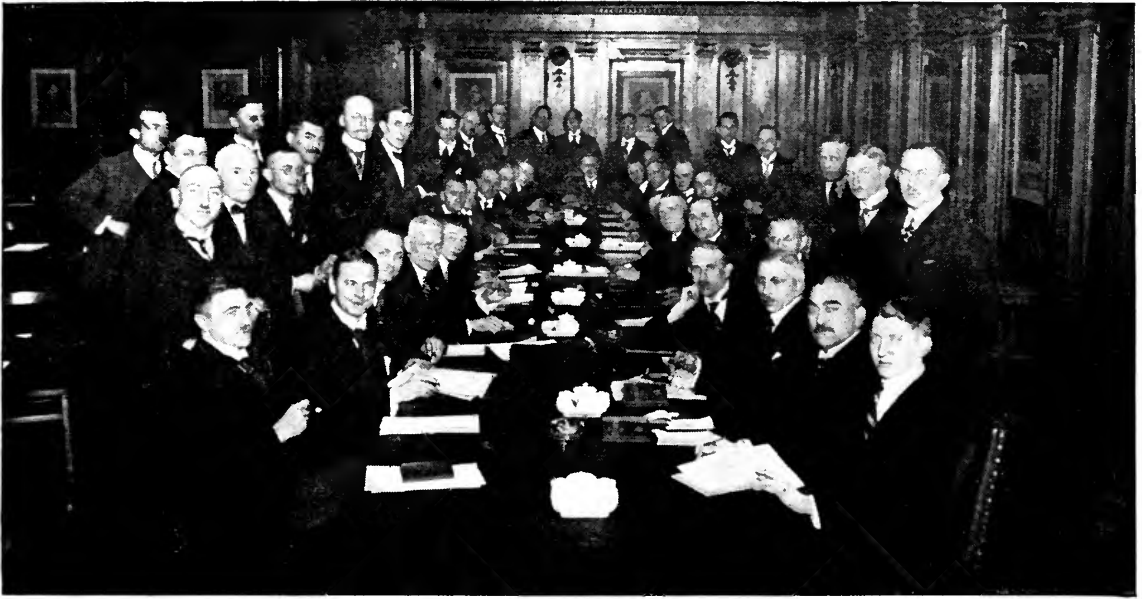

#### THE GERMAN RADIO CLUB

Meeting in Berlin in the General Post Office with Dr. Bredow, chief of the telegraph, telephone, and broadcasting services in the chair

## What German Listeners-In are Up Against

A Berlin Amateur's Story of What Government Restriction, High Prices, and Poor Apparatus are Doing for Broadcasting

By KURT HILDESHEIMER

**W**E ARE up against the wall here in Germany. No amount of cussing helps. You can't get this and you can't get that, and when you do get something, it is poor stuff. An insulator is nothing but baked mud, taps come off, parts don't fit, and then you begin to chuck the stuff against the wall and go to bed swearing never to touch any of it again. But the next night you are at it again, fishing around for signals.

You have to pay about two months' total income to buy a decent one-bulb receiver. The three shops which are selling radio apparatus in Berlin are handling dismantled former army sets. They don't know the resistance of the grid leaks they sell, they don't know the ratio of the transformers, and you can't get a variable condenser with a vernier anywhere.

The amateur who wants to buy a set must be a German subject, or, if he is a foreigner, licenses will be granted only to citizens of such nations as reciprocate in the granting of licenses to Germans. He must prove his identity and must be more than 21 years old. The postal authorities have the right to refuse the license if they assume that the amateur will in any way abuse his permission to listen-in.

This license does not make it possible for him to listen-in. It merely gives him official permission to listen-in. For the license, he pays 25 marks (equal to \$6). This is to-day 90,000,000 paper marks and the average wage-earner is receiving 10,000,000 to 15,000,000 paper marks a week. The license is good for one year and must be renewed after that time by payment of the same fee. However, the Government does not guarantee any of its programs,



nor even that there will be any programs. The license cannot be transferred and is good only with apparatus bearing the same number as the license. Only such sets, parts, tubes, may be used which are stamped with the stamp of the R. T. V. (Reichstelegraphenverwaltung)

This article is not of a particularly optimistic or constructive tone; it is simply the outburst of a radio experimenter who chafes under the apparently unjust restrictions that prevail in Germany to-day. It possesses the merit of frankness, however, and although we do not vouch for the accuracy of the statements made, we believe they are sincere and indicate, in general, the true color of radio conditions beyond the Rhine.—THE EDITOR.

—the Federal Telegraph Administration. It is prohibited to change anything in the set which might alter the wavelength. The antenna may have a maximum length of fifty meters.

The sets may have ranges from 200 to 700 meters. The sets may under no circumstances oscillate. The wavelength restrictions, of course, eliminate all sets in which tuning is done with honeycomb coils. Only German firms are permitted to sell sets.

It is evident that all these limitations are

designed to prevent the amateur from reaching out with these crippled sets and trying to listen to an English, French, or Dutch program.

It is evident that all this checking-up and controlling and license-issuing and stamping of apparatus will cut heavily into any profit

which the Government might derive from the high fees.

The stamping fees are in gold marks:

For a crystal detector set . . . . .	2.50	[\$0.62]
For a tube set without amplification . . . . .	6.00	[\$1.50]
For a tube set with amplification . . . . .	7.00	[\$1.75]
For a tube . . . . .	0.50	[\$0.12]
For every added stage of amplification . . . . .	1.00	[\$0.25]

(The Post Office, by the way, does not guarantee the quality of the sets or that no patents have been infringed by the manufacturers!)

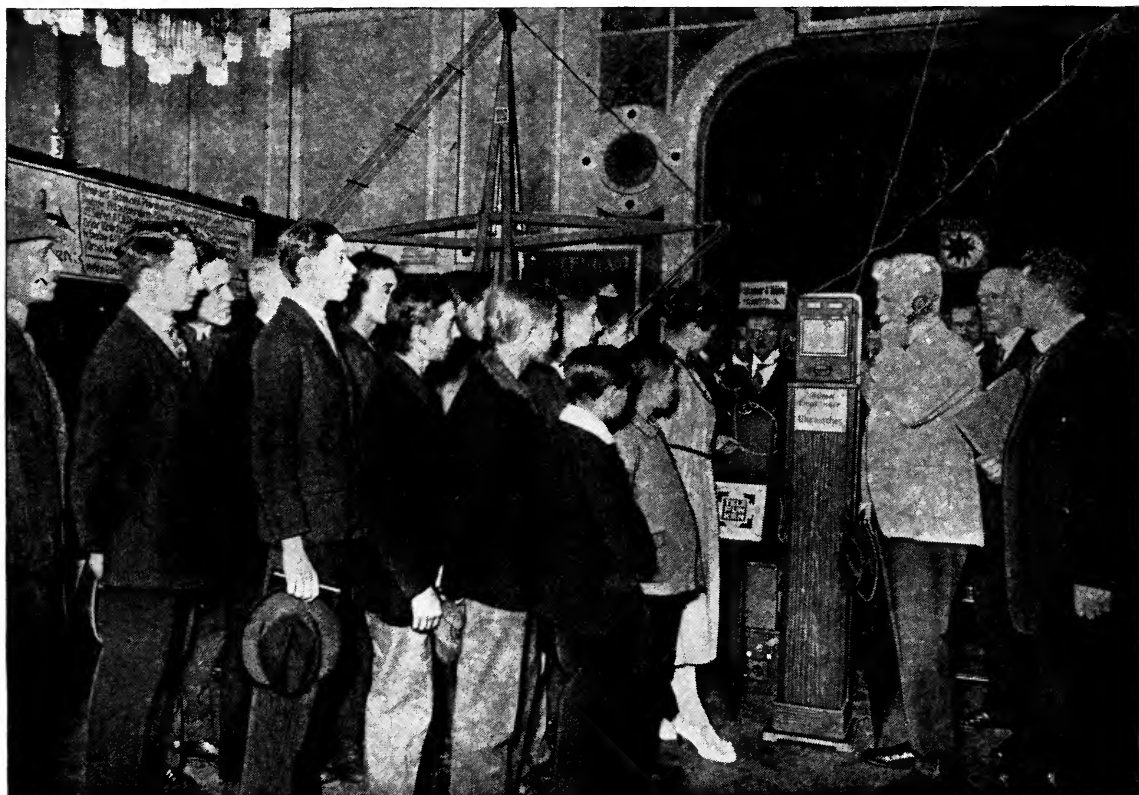

LISTENING TO TIME SIGNALS

From POZ, at Nauen, Germany, at a German radio exhibition. Broadcasting in Germany has not attained nearly the same popularity as in the United States

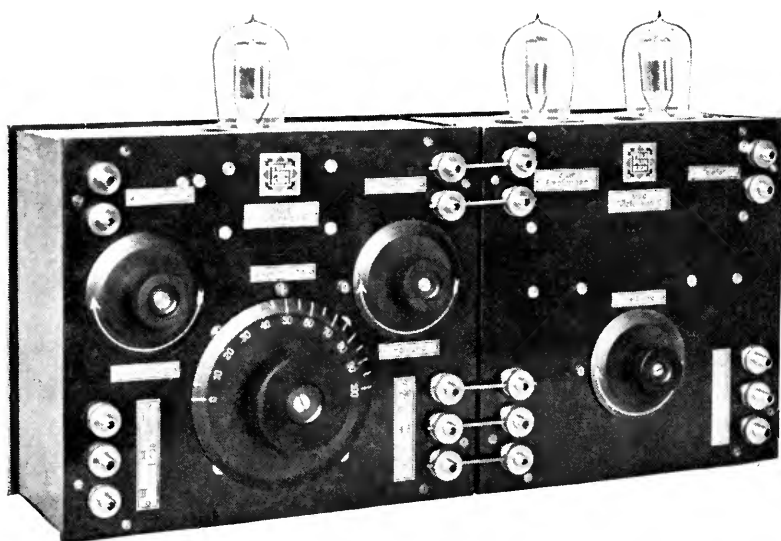

A GERMAN "DETECTOR AND TWO AUDIO" OUTFIT

It is built by the Telefunken Company and is quite beyond the financial reach of most German radio enthusiasts

#### THE DANGER OF CONFISCATION

WHEN you have all your material together and have infringed 121,567 rules and laws in buying your stuff, the obstacles to getting any use out of a set are almost prohibitive. Every time I receive, I climb up my antenna tower and string up my aerial. Then, after I shut down for the night (or at six o'clock the next morning), I go up the tower again and take the aerial down. It is a nice game and the first fifty-six years are the hardest.

And then every night you may sit and listen for broadcasting which isn't there at all. The nearest stations are in Paris, London, and the Hague. But these must have peculiar broadcasting hours, as I haven't been able to catch them yet. London is apparently too far off for one bulb without amplification. So all the fun you have is dit-dah-dit dah-dit. You begin to feel you are lucky at that. Of course, there is no checking up of wavelength and you can never tell where or when you can tune-in on anything. How is the novice ever to try out a circuit or to know what is wrong?

Now that the German radio law is what it is, we can only groan and shed a few tears at it. It does not even give you a chance to fight; it just kills you. I am sure that in spite of all this, I would ultimately have been able to pick up English, French, and perhaps American programs. Now I am really expecting a raid every day. It is nothing short of preposterous

the way the Government is killing off activities and is reserving radio for a few profiteers who can afford to pay any price. Besides, it would never appeal to me to have a sealed-up receiver without a chance to go after long-distance stations and to improve my knowledge of radio.

Here a government running the largest (at least, I think it is) station in the world (POZ, at Nauen) and operating directly with many countries on long wavelengths, is suppressing the amateur "because he might disturb the regular traffic." We don't want sending licenses for the

present, only the right to experiment with this wonderful art. If the Government cannot code their messages with one of the well-known coding typewriters, or if they cannot use high-speed telegraphy, they will not be able to suppress the man who really intends to exploit the news he hears. He can have his loop and high-powered set in some back room and receive without anyone ever finding it out.

We amateurs would be glad to pay for an experimenting license, if one could be had within reason. We would not think of listening to any telegraph messages. But I know that I am not going to the Post Office to get a license which would allow me to buy a set, because my name would then be on record, and I would have more trouble than fun.

#### THE FIRST GERMAN RADIO CLUB

THE Deutscher Radioklub was organized in Berlin in the spring of 1923. It developed rapidly and attracted wide attention. Of course, the authorities frowned on the club, and the first series of lectures with demonstrations were followed by official summons to the lecturer, who was a scientist of renowned standing and the holder of an experimenter's license. He was cautioned not to use his sets again outside his laboratory or his license would be cancelled.

The fees for members could not be fixed in marks on account of the upset currency situation in Germany. At present the fees are 10

times the postage on an ordinary letter as entrance fee, and 6 times this postage as monthly fee. This is to-day 10 billion and 6 billion paper marks.

The Radioklub tried to spread information as well as it could through meetings, lectures, demonstrations, and newspaper articles. After some time the Post Office was no longer able to evade the pressure brought to bear on it from all sides.

#### A BROADCASTING COMPANY STARTED

AT ABOUT this time, the public was astonished to find that the Government has already been "studying the question" since January, 1922. A company called "Die Deutsche Stunde" (the German Hour) had been floated by the Post Office and some of the large firms. Experiments were started in 1923 from the Government station, LP, in Koenigs-wusterhausen, also from the Telefunken station in Berlin and from the Lorenz station in Eberswalde near Berlin.

Broadcasting was quite irregular and chiefly

intended to find out the best conditions under which the service could be finally started. It was during these experiments that the Government claims to have found out that it would be necessary to limit the future broadcasting service considerably, as it might otherwise be disturbed through the enormous traffic between all the surrounding countries. It was stated that the number of waves still available was very limited and this was one of the chief reasons why the amateur activities were going to be carefully watched. However, this statement of the Government can hardly be reconciled with the fact that the commercial traffic is without exception carried on with longer waves than would be required for the amateur broadcasting service.

#### THE WICKED EXAMPLE OF THE U. S.

A PARTICULARLY striking example of the way in which the public was misled was by newspaper articles about the American Radio Conference under Secretary Hoover. It was stated in these articles that the chaos



GERMAN BROADCAST LISTENERS

Using a receiver which is quite generally sold by one of the broadcasting companies. These receivers are sealed and can only be used over a certain band of wavelengths

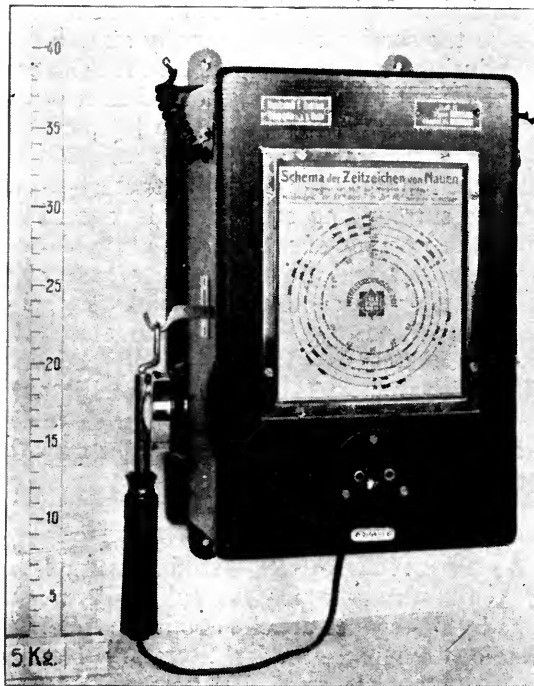

#### FOR TIME SIGNALS ONLY

A neat German receiver, tuned exactly to the wavelength of POZ, Nauenz. The listener has no adjusting to do. The diagram on the panel explains how the dots and dashes sent during the five-minute period indicate the correct time

in the U. S. had grown so bad that nobody was able to pick up anything on account of interference but shrieks, growls, and hisses. The public was urged not to follow the "wicked" example of the U. S. and England, where nobody was paying fees for receiving and where the whole broadcasting service would soon break down for lack of funds, but to be a good boy and rely on the ever-so-well-meaning Government and run away and play till everything had been carefully considered.

In October, 1923, the press was invited to attend the first trial demonstration in the Telegraphic Technical Experimental Laboratory in Berlin. A concert and declamations were broadcast from Koenigswusterhausen. At the same time, the exact regulations were printed in a paper published exclusively for the German public broadcasting service, *Der Deutsche Rundfunk* (The German Broadcasting Service). This paper published the laws, the reasons of the Government for limiting the amateur activities, and in the future it will also publish the programs.

The first idea of the Government was that

this new sport was a fine field for taxation, so it piled it on thick and heavy. A tax is levied on sets and on licenses for amateurs. The necessity of such taxation was explained by the budget deficit. A large part of the tax should also go toward creating so good a program right from the start, that people would not lose interest after a short time in the radio game, if it did not come up to their expectations. It was the question of who was going to pay for the broadcasting. Here in Germany it is going to be the amateur directly. Of course the Government knows that only a comparatively small number of people will apply for licenses right away so they are cautioning the public not to expect too much for their money in the beginning. The question whether the manufacturers would be willing to bear the expenses of broadcasting has never been raised yet. It is certain, however, that they would be glad to contribute directly to it in order to profit by the consequent sale of sets and not be subject to taxation and bureaucratic control measures.

A certain part of the fees collected from the amateurs goes to the Government and the balance to the Deutsche Stunde or other broadcasting organizations.

#### MAKING RADIO "POPULAR"

**B**ROADCASTING will take place from the Government station in Koenigswusterhausen and from the Voxhaus in Berlin. This is a private firm making gramophones and records, and while the records are being made in their Berlin studio, the music will be picked up and broadcast. Other broadcasting stations are planned in Munich in Bavaria and in Stuttgart in southern Germany. All will work on different wavelengths to prevent interference. Every station is intended to supply a district of 150 kilometers radius.

At the same time the Deutsche Stunde is going to lease lecture rooms, concert halls, etc., from time to time and install portable receiving sets for the evening and have the lectures and music picked up and reproduced through loud speakers. This absolutely absurd idea is the best way of discrediting radio with the average German who has a highly trained musical ear. It would be like inviting somebody to attend a concert consisting of amplified gramophone records. People coming for the novelty of the thing will leave the place with an utter disgust for radio, when they

can listen to the best soloists, philharmonic orchestra, opera, etc. at slightly higher prices. Of course this is no way to popularize radio in a nation where 90 per cent. of the people know nothing at all of radio.

Another regulation: it is prohibited to receive other than the German programs. Just imagine the poor amateur when he gets tuned in on London dropping his headset in horror and ringing up the Government for instructions what to do, when he cannot tune it out. The owner is further responsible that nobody misuses the set. The government officials are authorized to enter and search any room in which radio sets are stationed just as if you were the vilest criminal.

The amateur (if people with such sets could justly be called amateurs, I think, however, they had better be labeled "wireless gramophonists") is thus crippled on all sides. No buying of parts, building his own, experimenting with different circuits, no amplification for him, he is just switched on to a kind of enlarged gramophone which works only certain hours of the day. No distance work, none of the thrill and fascination of listening to another country and knowing that you are one of the vast and enthusiastic wide-spread audience.

#### HOW THE PRESENT SYSTEM IS LIKELY TO WORK OUT

THE high costs of administration and the small number of subscribers in the beginning will prevent profitable utilization of the returns and listeners-in abroad cannot be taxed either. There will not be enough amateurs willing to pay the fees, knowing that they will be kept on record and subject to frequent examination and raids on their apparatus.

The quality of the service in the beginning will necessarily be poor, just when it is most essential to startle everybody with the high quality and frequency of the performances. It can be safely assumed that the enterprise of the manufacturers, who are eager to create an adequate outlet for their production and willing to cooperate in the broadcasting itself, can not be set aside for any length of time.

Of course there will always be quite a number of people who do not care about the technical part of radio. All they want is to hear the music and not be bothered with assembling the set or with technical knowledge. For these, the regulations may be all right if they can afford to pay the high fees and the high prices for the receiving sets. But preventing all persons who are not 21 years old and all those who want to experiment from going ahead and doing it, is preposterous. The amateur who wants to experiment would be willing to pay for a license, even more than the fee stipulated at present.

However, as long as these crippling conditions prevail, Germany may as well definitely renounce any increase in the technical education and knowledge among the people, and the chance of any improvements or inventions from the ranks of the amateur.

I am afraid this has not been a particularly optimistic account of the radio situation in Germany. The fact is, I have looked pretty thoroughly without so far finding anything that would justify loud hoorays, or even any very cheerful expectations for the future. No one is waiting more anxiously for a good omen than I am; and when it appears I'll be among the first to join in the hymn of thanksgiving.

*HOW can we speed up our trans-oceanic and trans-continental radio messages? Is a new code the answer? Has the limit of speed been reached? Arthur H. Lynch has an exclusive interview with Major-General George Owen Squier in the June RADIO BROADCAST in which General Squier explains a startling and well-worked-out plan which he says would permit, according to his figures, an increase of more than 150 per cent. in the speed of radio telegraphic, cable and telegraph traffic.*

# Looking Into the Vacuum Tube

## WHAT MAKES THE WHEELS GO 'ROUND: III

What Happens in the Vacuum Tube and How

By WALTER VAN B. ROBERTS

Each of these articles is a unit in itself; you can start reading now. This is the third article in Mr. Roberts's series. The first appeared in this magazine for March.—THE EDITOR.

**T**HE vacuum tube is the heart of most radio circuits, and because of its calm appearance and almost uncanny action, many are persuaded they cannot understand its fundamentals.

Every one can see the three elements in the tube, called (reading, so to speak, from right to left), plate, filament, and grid. These elements are insulated from each other, although placed quite close together.

### 29. THE PLATE CIRCUIT

**R**EFER to Fig. 9. A wire called the filament is heated (in the best possible or "hardest" vacuum) by means of electric current from the filament heating battery which is usually called the A battery. If heated to a temperature sufficiently high (the necessary temperature depending upon the kind of wire the filament is made of) a large number of electrons are emitted from the filament, like steam from boiling water. They are then sucked over to a sheet of metal called the "plate" which attracts them because it is kept at a potential more positive than that of the filament. This flow of electrons to the plate constitutes the plate current, and the battery that keeps the poten-

tial of the plate positive and hence maintains the plate current is called the plate battery or the B battery. Electrons leave the filament, are attracted through the vacuum to the plate, leave the vacuum tube via a wire sealed through the glass, traverse the B battery, re-enter the vacuum tube by the filament leads along with the filament heating current, and get boiled off the filament again for another round trip.

### 30. THE GRID

**S**O FAR only two electrodes have been mentioned, for the hot filament is considered as only a single electrode although actually two wires are sealed through the glass in order to provide a complete circuit for the heating current. The third electrode is called the "grid" because it is usually in the form of a lot of parallel wires close together and all connected together. When this structure (which is located between the filament and the plate) is given a potential more negative than that of the filament, it repels electrons coming from the filament and thus offsets some of the attractive force due to the plate. It is a very important property of the tube that a small change in the grid potential may be as effective in changing the plate current as a large change in plate potential. The voltage amplification constant,  $\mu$ , of a tube may be defined as the number of volts that must be added to the plate battery to compensate for making the grid one volt more negative. If the grid is made more positive than the filament, it attracts electrons so that the plate does not get them all. Those electrons going to the grid constitute a grid current and to maintain this current power must be supplied by the source that is keeping the grid positive. Inasmuch as the most important function of the vacuum

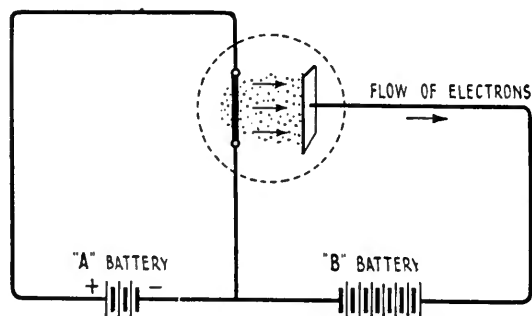

FIG. 9

A simplified diagram showing how the vacuum tube works

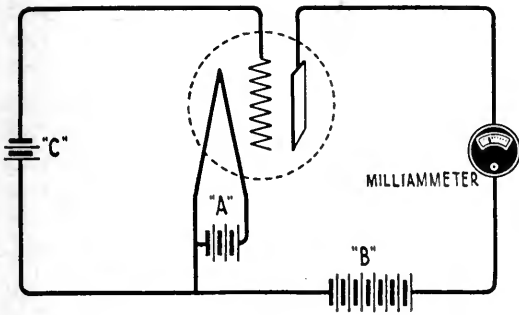

FIG. 10

The essentials of a vacuum tube circuit. The milliammeter measures the plate current

tube is the amplification of power, it is important in almost every case that the grid be kept negative at every instant in order that, as nearly as possible, no power at all be required to maintain or vary the grid potential. (The quantity  $\mu$  does not have to be greater than unity in order that the tube be capable of amplifying power). Wherever we say that the grid or plate potential is so much more positive or more negative than the filament, we always refer to the most negative end of the filament, the latter not being an "equipotential surface" when the heating current is flowing through it.

31. PLATE IMPEDANCE

ANOTHER very important quantity is the ratio of a small change in plate potential (measured as a fraction of a volt) to the resulting change in the plate current (measured as a fraction of an ampere). Of the various names given to this quantity the term "plate impedance" will be used. Except at extraordin-

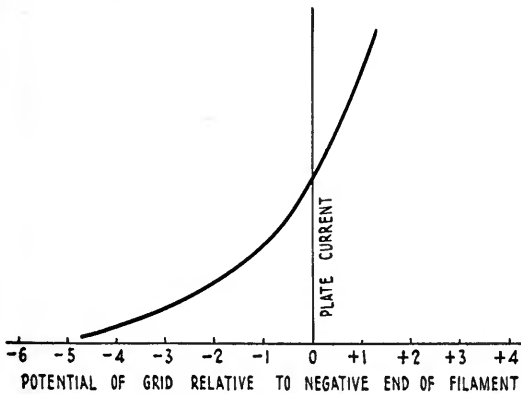

FIG. 11

How the plate current varies in a vacuum tube when the B battery is constant and the polarity of the grid potential is varied

arily high frequencies the plate impedance is practically the same as a pure resistance, so that it may be equally well called the plate resistance, and denoted by  $R_p$ .

31. MUTUAL CONDUCTANCE

THE ratio  $\frac{\mu}{R_p}$  is called the "mutual conductance" (being the change in plate current per volt change in grid potential) and this term is coming into use as a convenient figure of merit for a tube.

The quantity,  $\mu$  is simply a geometrical con-

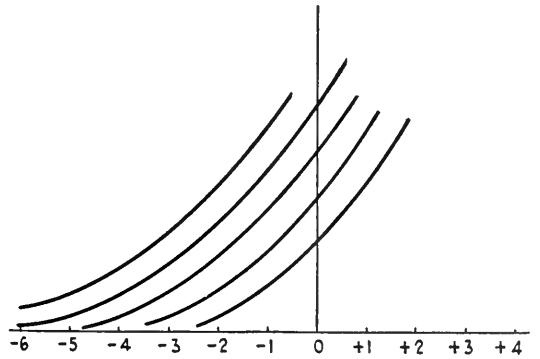

FIG. 12

By varying the B and C battery voltage applied to a vacuum tube this family of plate-current curves results

stant, being greater the larger the wires forming the grid, the closer they are together, and the further they are from the plate.  $R_p$  however depends not only upon the actual geometry of the tube but also upon the copiousness of emission of electrons from the filament, and the grid and plate potentials. Hence it is customary to specify the value of  $R_p$  for the filament current, grid potential, and plate potential at which the tube is supposed to be used.

Most receiving tubes have the value of  $\mu$  somewhere between 5 and 10 and  $R_p$  about 20,000 ohms more or less. Some tubes have  $\mu$  as high as 40 and  $R_p$  as high as 100,000 while others have  $\mu$  only about 2 and  $R_p$  as low as 1,500, but tubes with these extremes are used only for special purposes.

33 GRID POTENTIAL—PLATE CURRENT

FIG. 10 shows a tube with an A battery to heat its filament, a B battery to maintain its plate current, and a C battery to keep its grid negative, and a milliammeter to measure the plate current. If the B battery voltage is



kept constant while the C battery voltage is varied, the plate current will be found to vary as shown by the curve of Fig. 11. This curve is called the "plate current-grid potential characteristic" of the tube. By making such a curve for each of a number of different B battery voltages we obtain a "family" of curves as shown in Fig. 12. From inspection of this family of curves it is easy to find what the current would be for any combination of B and C battery voltages.

#### 34. THE "SQUARE LAW" EQUATION

HOWEVER we do not use this chart much, for it is a very fortunate circumstance that for all purposes in which we will be interested, the simple equation  $I_p = K (B + \mu C)^2$  gives the plate current with sufficient accuracy especially if there is not much impedance in the plate circuit. ( $I_p$  is the plate current, B the number of volts in the plate battery, C the number of volts in the grid battery, and if the grid is negative a minus sign must be used, and k is a constant whose value depends upon the particular tube used, and even with a given tube depends upon the amount of filament current). If we had only the experimental family of curves of Fig. 12 as a guide to the behavior of the tube, we could reason out results quite well in a qualitative way, but by using the equation we can work out quantitative results very much more quickly and simply by straightforward elementary mathematics, and we will not be so likely to overlook unexpected effects. However, for all practical purposes, the curves of Fig. 12 will be found quite satisfactory.

#### 35. SUPERIMPOSITION OF ALTERNATING CURRENT UPON DIRECT

SO FAR, all the currents and potentials mentioned have been direct. As our interest is centered on alternating currents, it should be explained here that if in addition to the C battery an alternating potential be applied to the grid, causing the grid potential to fluctuate about its mean value "C", then as a result the plate current will also fluctuate about its mean value. But as mentioned before, a unidirectional current whose strength varies about a mean value can be considered to

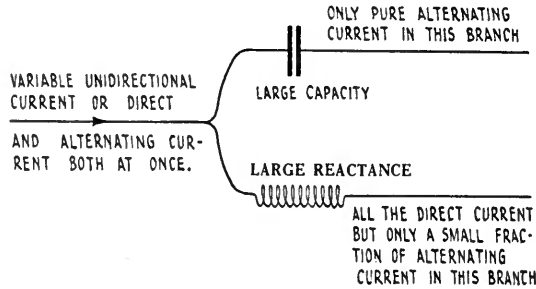

FIG. 13

be *two* distinct currents flowing simultaneously in the same wire: the first a direct current of constant strength, and the second an alternating current whose strength depends upon the amount of fluctuation. These two currents can be, and often are, fairly completely separated out from each other by the device shown in Fig. 13. Direct current cannot flow through the condenser so it *all* goes through the other branch. On the other hand if the inductive reactance is very large in the other branch compared to the condensive reactance of the condenser (at the frequency used) most of the alternating current will take the easier path, that is, the condenser branch. It is not always necessary to effect this separation. The whole alternating operation of the tube may be summed up by saying that against a background of direct currents and voltages, the tube receives an alternating voltage input to its grid and delivers an alternating current output in its plate circuit.

*Experiments using the two-element tube in reflex circuits are described in the Lab Department next month. The host of reflex users will have a whole new field of experiment thus opened to them*

# WHO IS TO PAY FOR BROADCASTING AND HOW?

*A Contest Opened by RADIO BROADCAST  
in which a prize of \$500 is offered*

## What We Want

A workable plan which shall take into account the problems in present radio broadcasting and propose a practical solution. How, for example, are the restrictions now imposed by the music copyright law to be adjusted to the peculiar conditions of broadcasting? How is the complex radio patent situation to be unsnarled so that broadcasting may develop? Should broadcasting stations be allowed to advertise?

These are some of the questions involved and subjects which must receive careful attention in an intelligent answer to the problem which is the title of this contest.

## How It Is To Be Done

The plan must not be more than 1500 words long. It must be double-spaced and typewritten, and must be prefaced with a concise summary. The plan must be in the mails not later than July 20, 1924, and must be addressed, RADIO BROADCAST Who Is to Pay Contest, care American Radio Association, 50 Union Square, New York City.

The contest is open absolutely to every one, except employees of RADIO BROADCAST and officials of the American Radio Association. A contestant may submit more than one plan. If the winning plan is received from two different sources, the judges will award the prize to the contestant whose plan was mailed first.

## Judges

Will be shortly announced and will be men well-known in radio and public affairs.

## What Information You Need

There are several sources from which the contestant can secure information, in case he does not already know certain of the facts. Among these are the National Association of Broadcasters, 1265 Broadway, New York City; the American Radio Association, 50 Union Square, New York, the Radio Broadcaster's Society of America, care George Schubel, secretary, 154 Nassau Street, New York, the American Society of Composers and Authors, the Westinghouse Electric and Manufacturing Company, the Radio Corporation of America, the General Electric Company, and the various manufacturers, and broadcasting stations.

## Prize

The independent committee of judges will award the prize of \$500 to the plan which in their judgment is most workable and practical, and which follows the rules given above. No other prizes will be given.

*No questions regarding the contest can be answered by RADIO BROADCAST by mail.*

# How to Increase Your Range

Details on How to Apply Radio-Frequency Amplification to Single and Two-Circuit Regenerative Receivers, Preventing Radiation

## PART II

By JOHN B. BRENNAN

**M**ANY have inquired about details suggested by the article by Mr. Arthur H. Lynch "How to Increase Your Range," in the March RADIO BROADCAST. This article will attempt a further explanation in an effort to simplify the construction of the radio-frequency unit there recommended and described.

The photographs accompanying that article merely illustrated the use of the amplifier unit with the coil B coupled to a single circuit receiver.

Coil A is wound as was described, with 80 turns of No. 25 DCC wire, tapped every 20 turns. It is not bank wound, as shown in the lower right photograph, Fig. 3, page 381, March.

The amplifier unit is shown in Fig. 1. When applying this unit to a standard

three-circuit regenerative receiver such as Fig. 5, page 440 in RADIO BROADCAST for March, the following changes are necessary; Disconnect the antenna and ground leads from the primary of the regenerative set and connect them to their respective posts on the amplifier unit as shown in the correct circuit below. Connect the primary or stationary coil of the coupler in the regenerative set to the posts Nos. 8 and 9 (Nos. 1 and 2 as in Fig. 1, next page). This primary coil then becomes coil B (See Fig. 1, page 380, March). The filament circuit must be checked over so as to prevent short-circuiting of the A battery. The set is now ready for use.

By referring to Figs. 1 and 2 the method of connecting to a single circuit receiver will be quite evident. The antenna and ground leads of the single circuit receiver are disconnected from the binding posts and in their place is connected the piece of wire E. This operation shunts the

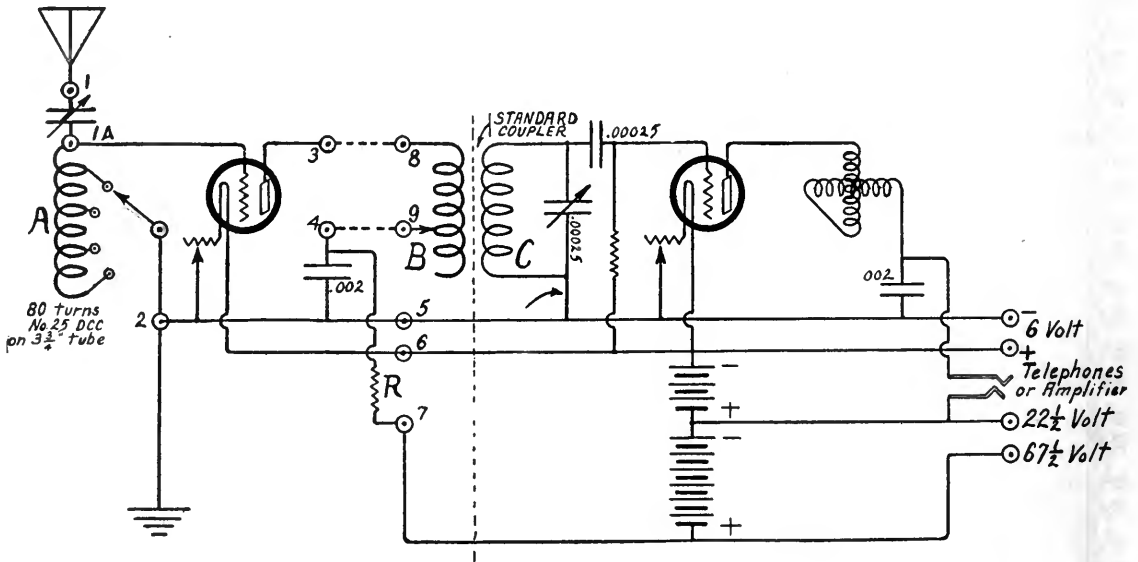

THE CORRECT CIRCUIT

For changing your single-circuit receiver into a non-blooper by adding a stage of radio-frequency amplification. This is the same circuit which appears on page 380 of this magazine for March. There are several corrections: Coil C, lower lead goes to the - 6 volt lead. If a loop is used in place of an antenna and ground, connect posts 1 to 2 and plug loop in at points 1 and 1A

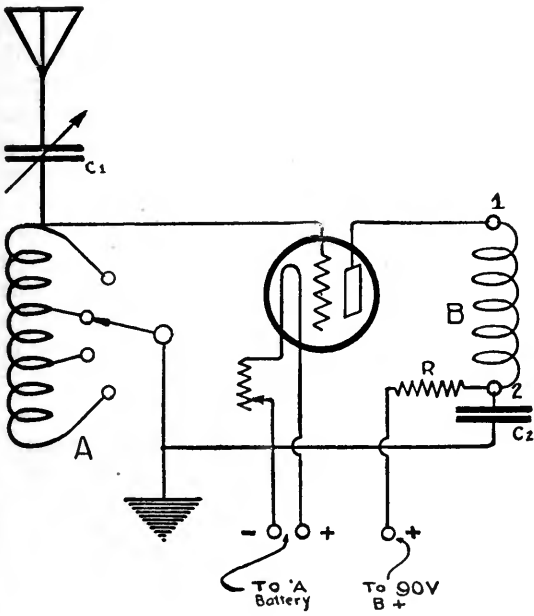

FIG. 1  
The radio-frequency unit

variable condenser across the primary coil resulting practically in the equivalent to Fig. 1, page 380, March, with the exception that instead of a plate variometer, we have a rotating coil D coupled to the coil C. The terminals Nos. 1 and 2 of Fig. 1 are connected to the 45-turn coil B and this is loosely coupled to the coil C. The construction of the coils A and B were explained in the March issue; however, a brief resumé follows:

About 150 feet of No. 25 DCC wire will be plenty for the winding of both coils. The tubing for the coils A and B is of formica, bakelite or cardboard,  $\frac{1}{8}$  inch thick and  $3\frac{3}{4}$  inches in diameter. The tube for A is 3 inches wide and for B, 2 inches wide. A margin of about  $\frac{3}{8}$  inch is left on either side of the winding of both coils.

It is to be noticed that the grid leak, which usually shunts the grid condenser, is connected to the positive side of the filament supply as shown in Fig. 2.

One more word about the single circuit receiver. There are many variations and modifications of the single circuit, but in most cases they are of the same principle; that is, the antenna is connected through a variable condenser to a coil, thence through a selector switch arm to the ground lead. The grid and filament connections are usually taken directly off the coil proper. Sometimes this connection is

fixed; in other cases it is made variable by additional switch arms.

Unless the owner of a single circuit set is entirely familiar with the wiring circuit of his receiver, it is recommended that he secure the services of a competent radio mechanic to construct the amplifier.

To adapt this circuit to use for radio-frequency amplification, the antenna tuning

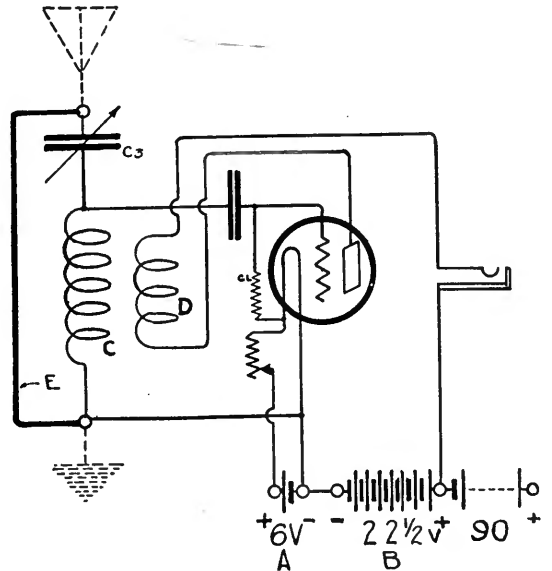

FIG. 2  
Connections necessary to change a standard single circuit regenerator to a non-radiator

condenser of the receiving set is shunted across the primary coil. This is usually accomplished by connecting the antenna and ground binding posts with the wire E as shown in Fig. 2.

An error occurred in the wiring diagram in the March issue, page 380. The bottom side of the coil C had been left disconnected. It should be connected to the negative or ground lead.

In Fig. 1, A 80 turns No. 25 D.C.C. wire, tapped every 20 turns; B 45 turns No. 25

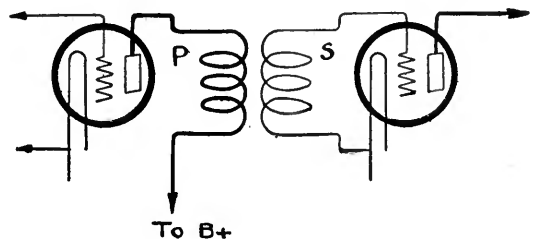

FIG. 3  
Circuit of the untuned transformer-coupled amplifier

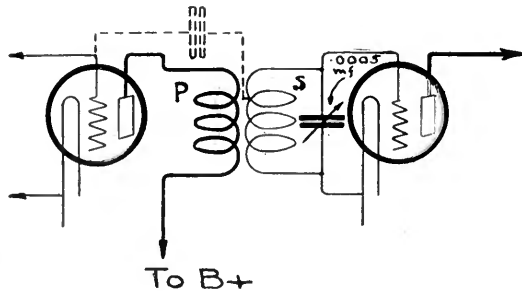

FIG. 4

The tuned transformer-coupled amplifier. Dotted lines show how and where to include neutralizing capacity

D.C.C. wire tapped every 15 turns;  $C_1$  and  $C_2$  .00025 mfd. condensers;  $C_3$  .002 mfd. fixed condenser;  $R$  300-ohm potentiometer.

#### MULTI-STAGE RADIO-FREQUENCY AMPLIFIERS

CONSIDERABLE interest has been shown in circuit diagrams showing several steps of radio-frequency amplification. It must be remembered that for every additional step, the control of the set becomes more sharp and often critical. This, in a large measure, defeats the very purpose for which the added steps were intended.

There are, however, means for overcoming this drawback in the form of neutralization and

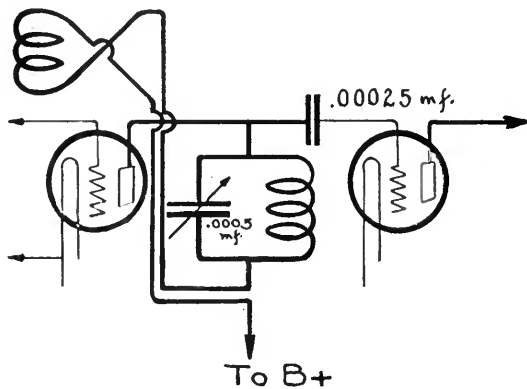

FIG. 6

The circuit for the Superdyne or negative feedback for the impedance-coupled amplifier

negative feedback. Both methods will be discussed.

In general, some of the various forms of radio-frequency amplification are: untuned transformer-coupled, tuned transformer-coupled, tuned impedance-coupled, and resistance-coupled.

The untuned transformer-coupled type is not equally efficient over its entire wavelength range as it is for one certain wavelength within its band. In other words, it has a peak value for most efficient operation. Several steps are needed to equal the performance of various of the other types. See Fig. 3.

The tuned transformer-coupled type was, and perhaps still is, very difficult to tune except where proper steps have been taken to include the neutrodyne feature in the circuit. This renders the set free from the self-oscillation of

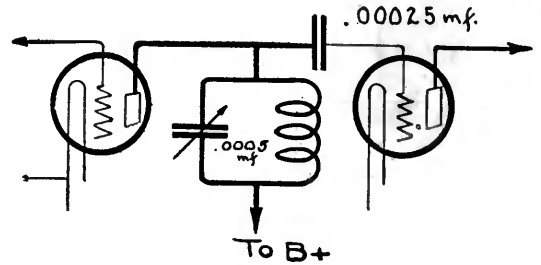

FIG. 5

Circuit for the tuned impedance-coupled amplifier

the tubes, allowing easy yet sharp control. See Fig. 4.

The same oscillation trouble was true of the tuned impedance-coupled amplifiers, but the use of the negative feedback, or Superdyne method, partly eliminated this drawback. See Figs. 5 and 6.

In Figs. 3, 4, 5 and 6, only single stages of the radio-frequency amplifier units have been shown. With the exception of the Superdyne method, for more than one stage of amplification the circuit for the successive units would be the same, that is, the output of one would be connected to the input of the following unit.

Several of these various types of radio-frequency transformers were dealt with in great detail in past issues of RADIO BROADCAST. A reference list follows:

For untuned R. F. transformers, see page 393, March, 1923, issue.

For tuned R. F. transformers see page 393, March, 1923, issue, page 499, April, 1923, issue, and page 214, July, 1923, issue.

For neutrodyne system, see Dec., 1923, Jan., 1924, and Feb., 1924 issues.

For resistance-coupled amplifier, see page 330, Feb., 1923; also this issue page 39.

# How to Build the Knock-Out Two-Tube Set Behind a Panel

By WALTER VAN B. ROBERTS

It is worth knowing that this circuit has given excellent satisfaction as to distance, is not hard to build, and is sensitive and *does not radiate*. Mr. Roberts began work on the circuit last December and his original descriptive article appeared in RADIO BROADCAST for April.  
—THE EDITOR.

**I**N RESPONSE to the demand for a better looking arrangement of the circuit described by the writer in the April issue of RADIO BROADCAST, the sets shown in the photographs have been built, and work about as well as the original arrangement. For one set the coils were wound on five and ten cent store spider web forms, and a five and ten cent store brass arm was used to operate the tickler coil. The other set makes use of coils built especially for this use by the Turney Laboratories, and can be wired so as to appear somewhat neater. It has adjustable coupling between coils P and S of the circuit diagram of Fig. 1. This feature allows maximum efficiency over the whole wavelength range, but it is recommended that only two or three values of this coupling be used. Variation of this coupling changes the condenser settings. For long waves, say 450 to 600, have P and S about  $\frac{1}{2}$  inch apart, for the range 300 to 450 have them, say 30 degrees apart, and for very short waves, have them fully separated. They can of course, be left at some compromise position, as in the

other set, and never varied. Both sets work about equally well.

## HOW TO BUILD THE SET WITH HOME MADE COILS

**F**OLLOWING are instructions for building the set using home made coils: Fig. 4 shows how to drill the panel. In case it is necessary to use other makes of parts than those specified, drill only the holes for their shafts according to Fig. 4, and then drill holes for their supporting screws wherever necessary.

A baseboard  $\frac{1}{2}$  inch thick with cleats  $\frac{1}{2}$  inch thick is used. Fig. 3 shows the positions of parts on top of the baseboard, together with the approximate arrangement of some of the wiring. The rest of the wiring is easily done by referring to the circuit diagram of Fig. 1. Coil A, the antenna coil, is mostly hidden in the photograph. Its inner lead goes to the antenna binding post, which is the upper left hand one when the panel is looked at from the front. The ground binding post, which is just beneath, connects to the rotating contact arm. The left contact point (viewed from the front

These parts are needed:

*If the set is entirely home built.*

- 2 General Radio (or equivalent) .005 mfd. condensers.
- .005 mfd. micadon
- .0025 mfd. micadon
- 2 25-ohm Cutler-Hammer resistance strips
- Amertran audio-frequency amplifying transformer
- 6-ohm rheostat
- UV-201-A socket
- UV-199 socket
- Grid condenser with grid leak clips; .00025 mfd. condenser, grid leak, 3 megohms
- bus bar (neutralizing capacity "C")
- bus bar for connections
- spaghetti
- binding posts
- panel, formica or bakelite
- wood sub-base
- contact points
- switch lever
- 3 coils (3 ten cent store spider web forms, wire, about No. 26 B & S)

*If the set uses purchased coils—*

same as above, except parts for the coils are omitted. Turney Laboratories coils and mountings.

Because of the great variation in price of these various parts, no price estimate is given. Any piece of apparatus which will do the same work as a special one mentioned in the article may be substituted for it.

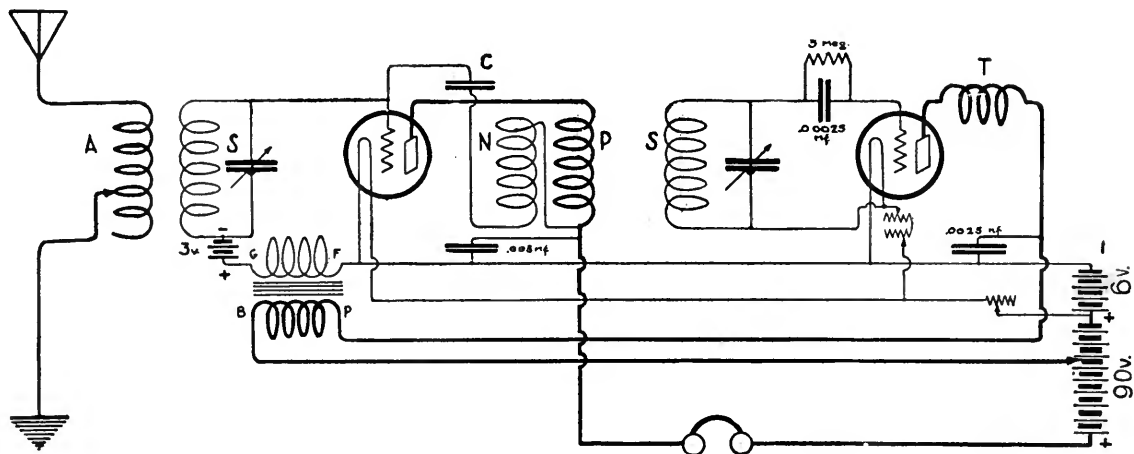

FIG. 1

The Roberts circuit. Revised as originally printed last month. Several changes have been made. A 3- instead of a  $4\frac{1}{2}$ -volt C battery is used, a .005 mfd. condenser is added in series with winding N, and in the grid return of the UV-199 is made through the — filament

of the panel) is connected to coil A one turn from the inner lead. The next contact point connects to the second turn. Point No. 3 goes to turn No. 5. Point No. 4 to turn No. 10. Point No. 5 to turn No. 20. Point No. 6 to turn No. 30. Point No. 7 to turn No. 40, which is the outer lead from the coil. Coil A is wound of No. 22 d.c.c. wire, winding over two teeth, then under two teeth, etc.

Coils S, one of which hides A in the photograph, are wound in a similar fashion, and with the same kind of wire, but there are 44 turns

and no taps. The separation between coils A and S should be  $\frac{1}{4}$  to  $\frac{1}{2}$  inch between centers. They are set slightly askew so that they "aim" at the centers of the coils at the other end of the board.

Coil T, the tickler, is the coil mounted on the rotating arm, and has about 18 turns of any kind of magnet wire wound any way. (If oscillations occur before the tickler is turned down somewhere near the other coils, there are too many turns on it. If oscillations do not occur when turned well down toward the other

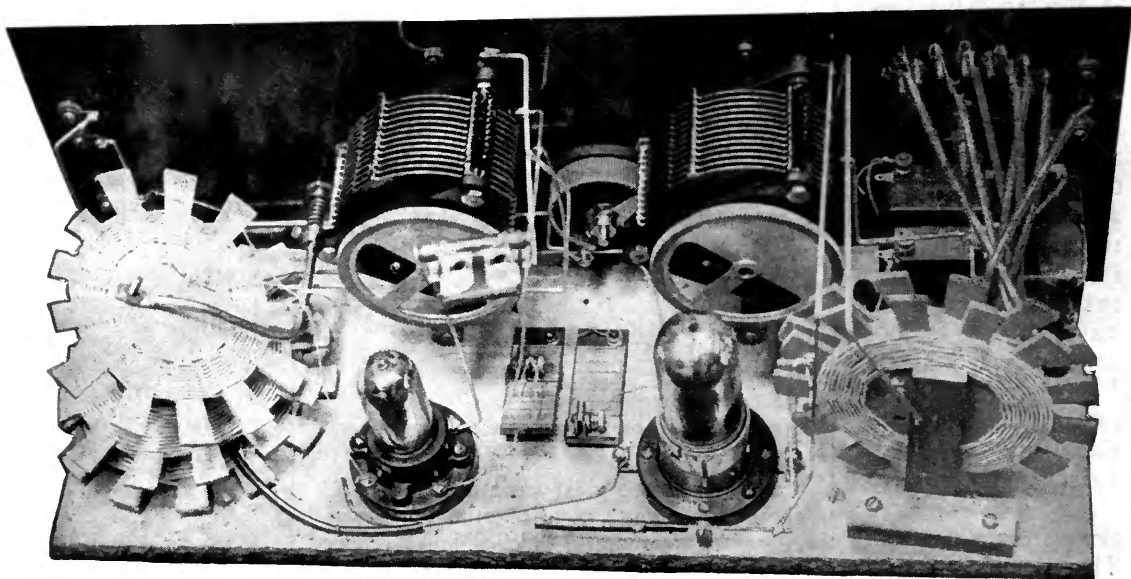

FIG. 2

The home made set behind a panel. As can be seen, the construction is quite simple



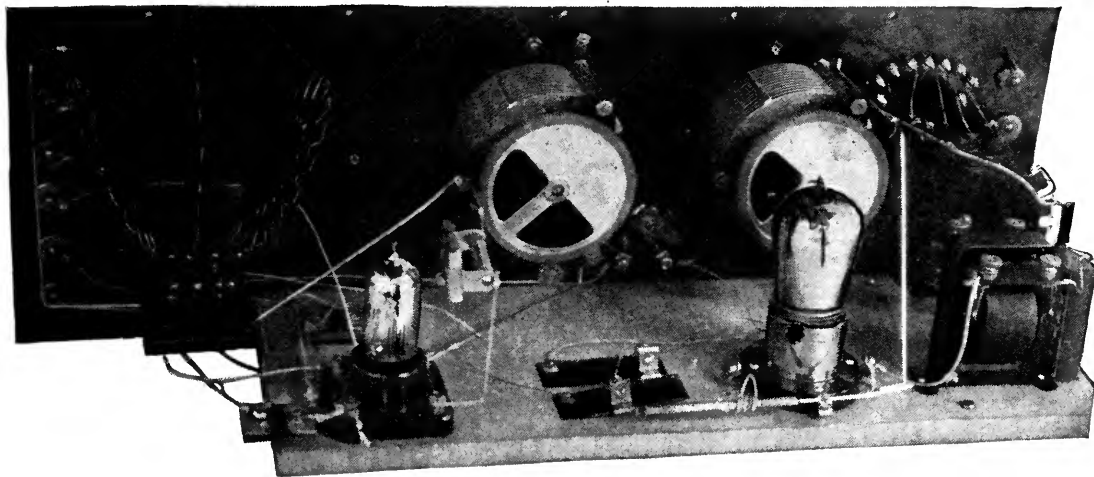

FIG. 3  
Behind the scenes of the Roberts circuit using the manufactured coils

coils, the tickler is probably connected backward.)

The coil containing the windings N and P is the one lying flat on the baseboard. Coil S is screwed down on top of it, and separated about  $\frac{1}{2}$  inch by a piece of wood with a hole for the screw to go through. N and P are each 20 turns, being wound both at once by simply using a pair of wires instead of a single wire to wind with. Wind over one tooth, then under one, and so on. Use wires no larger than No. 26, preferably of different colors so that no mistake will be made in connecting up.

The sliding contacts on the two Cutler-Hammer 25 ohm resistance strips should be set so that there are about 35 ohms altogether. One slider at the end (about 20 ohms) and the other

at the middle, will be about correct. Never remove the 201-A tube from its socket while the filament of the UV-199 is lighted, as this will increase the current through the 199. Connect the outer lead of the coil S which is coupled to coil A, to the grid of the 201-A tube, but the inner lead of the other S coil to the grid of the 199. The stationary plates of the condensers are the ones that are connected to the grids in both cases as is indicated by the diagram. If the rotating arm on which the tickler is mounted happens to be bent the wrong way, saw it off and solder together the other way around. Be sure that the terminal marked P on the primary of the Amertran is connected to the tickler, *not* to the B battery terminal. If some other make of transformer is used, try

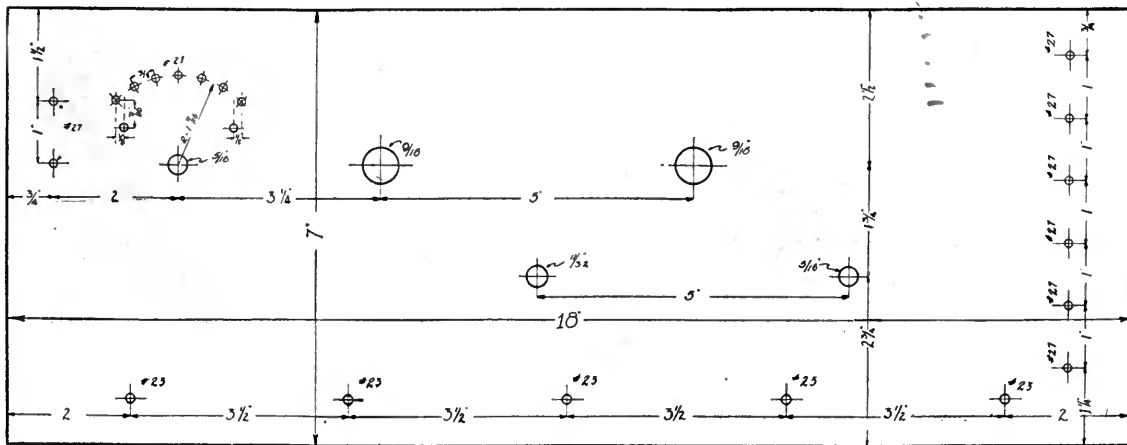

FIG. 4  
Panel layout for the home built set. The panel with manufactured coils is three inches longer

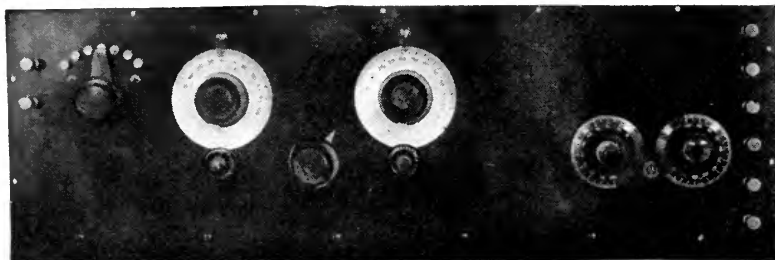

FIG. 5

Front view of set using manufactured coils. The experimenter has plenty of leeway in building his own set of this type

connecting its primary both ways to see which works right. In connecting windings N and P, first connect the *outside* lead of one to the inside lead of the other. Be sure not to simply connect the outside lead of one to its own inner lead.

The neutralizing capacity, C, is easily made by leaving two inches of bus bar projecting from the grid terminal of the 201-A tube. This is covered with spaghetti. A brass tube connected to the free end of winding N is then slipped over the spaghetti, fitting snugly. (Bare wire wrapped tightly around the spaghetti will do instead of the tube.)

See the article in the April RADIO BROADCAST for directions for adjusting the capacity C, and for the theory of the operation of the set.

#### THE SET WITH PURCHASED COILS

THE set using the Turney coils was built on a 21-inch panel to make it less crowded. The baseboard, however, is only 16 inches

long. Coils A and S are mounted 2 inches from the panel and parallel to it. The circuit is the same as in the other case, although the wiring is slightly altered to suit the different arrangement of parts.

In both sets, General Radio .0005 mfd. condensers with slow motion gearing are used. The rheostat is 6 ohms. The 201-A socket is a Paragon, while for the 199 tube, either Paragon, General Radio, or Radio Corporation sockets are recommended. Binding posts, contact points and panel, can be got at the five and ten cent store.

To get an idea of what performance to expect, the following is of interest: WGY is received quite satisfactorily on the loud speaker in Princeton, N. J. at any time of day, and KDKA can be heard faintly. At night KHJ is barely audible on the loud speaker, while KGO is almost loud, and can be separated perfectly from WLW, whose wavelength is only 1 per cent. different. (The respective settings of these two stations on the set using the home made coils are 23 and 22½.)

The original set described in the April RADIO BROADCAST is now being used by Dr. L. A. Turner of the Dept. of Physics, Princeton University, who has heard KGO on the loud speaker, using an indoor antenna!



## What Our Readers Write Us



### *With the Broadcast Listener in Samoa*

ALONG with this extraordinarily interesting letter from Mr. Roberts came several copies of a twenty-page radio bulletin which the enthusiastic listeners of Samoa issue "every once in a while" under the direction of Mr. Roberts who types the thing. We regret we haven't space for it. However, the transatlantic tests which RADIO BROADCAST sponsored last

November were by no means unsuccessful, as the flood of letters we received demonstrated conclusively.

Consulate at Apia, Samoa, January 21, 1924  
 Editor, RADIO BROADCAST,  
 Doubleday, Page and Co.,  
 Garden City, L. I.

DEAR SIR:

I have read in the January issue of RADIO BROADCAST an account of the transatlantic broadcasting tests. It ap-

pears that interest in the test was general, leading broadcasters, eminent engineers on both sides of the Atlantic, the press services, and prominent men cooperating in the tests.

Using super-heterodyne receivers at Garden City, faint voice and music was heard. The Radio Editor of the *New York Times* writing December 9, 1923, indicates that the tests from the view point of the American listeners were failures. Broadcasting stations, spark stations, and static interfered with the tests.

I have briefly summarized the results of the transatlantic tests as gathered from my latest magazines and papers in order to compare your results with the success of the transpacific tests now being carried on by WBAP the *Star-Telegram*, Fort Worth, Texas.

Incidentally, it may be of interest to learn that RADIO BROADCAST is responsible for the transpacific tests. Mr. G. C. Arnoux, Program Director of WBAP, read "When the Bug Bit in Samoa" in the October number of RADIO BROADCAST and wrote me suggesting a series of tests with Samoa.

The proposal was brought to the attention of the broadcast fans of Western Samoa who established a listening-in schedule drawn up to eliminate interference from Apia and Tutuila spark stations and from the single-circuit regenerative receivers in operation in the vicinity of Apia. Radio fans were to listen in on the following dates:

NPU Tutuila Radio Station, American Samoa. All dates.  
VMG Apia Radio Station, Apia, Samoa. All dates.  
Father J. B. Dumas, Aleipata, Upolu, Samoa. All dates.  
W. R. Ragsdale, Palauli, Savaii, Samoa. All dates.  
Quincy F. Roberts, Apia, Samoa. January 6, 1924.

11.30 P. M. to 12.30.

John H. Dixon, Apia, Samoa. January 11, 1924. 11.30 P. M. to 12.30.

VMG was given January 9, 1924. free from interference from the single circuit regenerative receivers.

All stations—January 21, 1924, and January 23, 1924. 11.30 P. M. to 12.30.

The difference in time made WBAP's transmitting hours from 5.00 A. M. to 6.00 A. M. January 7th, 10th, 12th, 22nd, and 24th.

On January 6, 1924, the music from the Coconut Grove Orchestra at the Ambassador Hotel, Los Angeles, transmitted through KFI ended. The next three hours were spent in cleaning connections, adjusting voltages, and changing tubes in an effort to find the right combination for best results. At 11.30 WBAP'S carrier wave came in. Adjustments brought in voice. Bang. Apia Radio opened up with its 8 kilowatt spark set. Tutuila came back with his broad spark. Several ship sparks joined the chorus. Both NPU and VMG had forgotten the Fort Worth tests. The telephone service was over hours earlier. There was no way of informing VMG that his spark was drowning out WBAP'S messages. We could hear voices and strains of music between the dots and dashes.

Static and interference had combined to make the first test a failure, but the strength of the signals was sufficient to convince the radio fans of Western Samoa that under more favorable conditions WBAP would span the Pacific.

Receiving conditions during the second test were slightly better. Static was heavy. Lightning flashed on three sides of Apia. Two or three ship stations were using a frequency which overlapped the Fort Worth wavelength.

WBAP, in the heart of Texas, came on the air at 5.00 o'clock in the early winter morning of January 10, 1924.

Radio enthusiasts of Samoa in the last half hour of mid-summer January 9, 1924 caught the signals.

Clear and strong the Texan spanned the Pacific with, "This is WBAP, the *Fort Worth Star-Telegram* of Fort Worth, Texas, United States of America calling

NPU—American Samoa,  
Savaii Radio Station—Savaii, Samoa,  
Apia Radio Station—Apia, Samoa,  
Mr. Quincy F. Roberts, American Vice Consul in charge,  
Apia, Samoa,

Father J. B. Dumas, Aleipata, Samoa,  
Mr. John H. Dixon, Apia, Samoa,  
Mr. W. R. Ragsdale, Palauli, Samoa,  
All stations in New Zealand, Australia, Java, Borneo, Sumatra, Japan, Philippines, and China.

If you receive this send a cablegram or a radiogram to the Radio Department of the *Fort Worth Star-Telegram*, Fort Worth, Texas, and we will refund telegraphic charges to you. This is station WBAP, *Fort Worth Star-Telegram*, Fort Worth, Texas, United States of America. Stand by. We will change to Morse then give you music."

Morse followed. Then the operator shifted to the pipe organ and a longing for home filling the hearts of the listeners brought tears to their eyes as old familiar melodies came through space.

My wife looked up and said. "We've been away too long. We must go home in April."

Then and there we decided to return to the United States in the Spring. Fort Worth's second test is bringing joy to a family in the hills of Tennessee and to another on the Great Lakes. Our relatives are receiving word that we are due in New York next May.

Imagination did not help in the long distance reception. Although static was exceptionally heavy and spark stations interfered, I can safely say that the entire program was received. It was possible for us to recognize the accent of the announcer. We marked errors in the pronunciation of Samoan village names as the speaker struggled through the list of places he called.

Mr. W. R. Ragsdale from Savaii writes, "Speech and music transmitted by Fort Worth came in at my station. The signals were very loud on a single dry cell tube. Conversations were recorded and will be submitted for verification upon the conclusion of the tests. Static and spark stations interfered badly, but it was almost impossible to miss WBAP and his cow bells."

Mr. John H. Dixon, Plant Engineer at Apia Radio reports, "Static was bad during my test with WBAP. I heard the announcer request South Pacific, New Zealand, and Australian, stations to report on the test. Organ music came in. As the names of the pieces played were not announced I can not give the complete program."

There are only two more stations to report. VMG did not listen in. NPU'S short wave receiver failed and was in Honolulu for repairs during the tests. Father J. B. Dumas and Doctor R. L. Christie have not yet had an opportunity to send in their reports to Apia from Aleipata.

The results so far are—three of the five broadcast fans of Western Samoa using a single tube variometer set, a single-circuit regenerative receiver with two stages of audio-frequency amplification, and a five-tube receiver with two stages of radio frequency and two stages of audio-frequency amplification succeeded in receiving WBAP through static and spark signals, a distance of 5,850 statute miles.

The reception of American broadcasting stations by the fans in Western Samoa is no longer considered remarkable.

Seldom are receiving conditions so unfavorable that music transmitted by the high powered Pacific Coast stations can not be tuned-in.

The following American stations are heard regularly in Samoa:

KFI	Los Angeles . . . . .	4,750 miles
KHJ	Los Angeles . . . . .	4,750 miles
KPO	San Francisco . . . . .	4,750 miles
KGO	Oakland . . . . .	4,750 miles
WJAZ	Chicago . . . . .	6,555 miles
	Wednesday working WNP	
WDAF	Kansas City . . . . .	6,110 miles
	Night Hawk Frolic	

Other stations heard at various times are:

KLX	Oakland . . . . .	4,750 miles
KGW	Portland . . . . .	5,080 miles
WBAP	Fort Worth . . . . .	5,850 miles
	Test only.	
CFAC	Calgary . . . . .	5,620 miles
	Test only	

An examination of the two lists clearly shows that international broadcasting between the United States and Samoa is carried on during the winter months of the temperate zone. Our small receivers consistently night after night reach out 5,000 miles and bring in American programs. It may be there is a scientific explanation for the long distance records made in Samoa. A study of the territory covered by the larger stations plotting the most distant points reached might be interesting. I know that maps showing the territory covered by KFI, KGO, KPO,

WHB, and WJAZ would be interesting to the amateurs of Samoa.

Very respectfully yours,  
QUINCY F. ROBERTS,  
American Vice Consul in Charge.

### *What to Do About Radiating Receivers*

Editor, RADIO BROADCAST,  
Doubleday, Page and Co.,  
Garden City, L. I.

DEAR SIR:

In your March issue, Mr. Dreher in his article "Is the Broadcast Listener at Fault" strikes the right chord when he states that the remedy for many of the listener's troubles lies in education of the public. First, the advertiser should be educated to state whether or not the receiver he is selling radiates; second, all radio magazines should be educated to state in connection with every "hook up" printed whether or not it is a radiating circuit, and third, all radio magazines should be educated to run continually instructions as to how to operate radiating receivers without raising the dickens for a dozen or so blocks around them. A new crop of suckers is born every spring and it takes the repeated instruction to keep up with the new crop. There might be added a fourth point, that the magazines should be educated to cease asking for reports on DX reception. Calling for such reports only serves to stimulate the "squealers" to greater activity.

You have started a good educational campaign, but I take it you have "some job" ahead of you yet.

Yours truly,  
P. R. VAN FRANK,  
Memphis, Tenn.

# The Grid

## QUESTIONS AND ANSWERS

The Grid is a Question and Answer Department maintained especially for the radio amateurs. Full answers will be given wherever possible. In answering questions, those of a like nature will be grouped together and answered by one article. Every effort will be made to keep the answers simple and direct, yet fully self-explanatory. Questions should be addressed to Editor, "The Grid," RADIO BROADCAST, Garden City, N. Y.

### NON-RADIATING RECEIVERS

*I read with great interest the article in the March number of Radio Broadcast on "The Truth About Trick Circuits." Allow me to congratulate you on the courageous stand you have taken.*

*I have been considering for some time, the purchase of a Tuska Superdyne receiver, but am now hesitating for fear it may be one of those referred to in the article. Will you please tell me if it is a re-radiating receiver?*

O. A. J., ROCKVILLE CENTER, N. Y.

**F**IRST allow us to correct our correspondent on the prevalent mis-use of the term "re-radiating." Re-radiating means, of course, radiating again which in very few cases is the phenomenon referred to when the term is applied to oscillating receivers. Re-

radiation occurs when resonant or tuned objects, such as wire fences, guy wires, the steel frames of buildings, etc., pick up energy from a near-by and powerful transmitter and, by impulse excitation, retransmit a portion of this energy on their individual wavelengths.

In the case of a banned receiver, the set itself is a small transmitting station, generating its own power which is sent out on the air to make itself evident as squeals and whistles in neighboring receivers. Thus the oscillating receiver is correctly termed a *radiating* set, the prefix *re* being unnecessary and meaningless.

The Tuska Superdyne receiver, when correctly operated, is not a radiating set, and many of our readers have found it a most satisfactory equipment. Oscillation in the first tube which results in radiation, is prevented by what is known as reversed feedback. Most of us who have used tickler feedback receivers have learned that the receiver

will generate and oscillate only when the tickler coil is "connected in the right direction." If the leads to this coil are reversed, the effect is quite the opposite of regeneration—the circuit refuses to oscillate, and signals are weakened as the tickler is more closely coupled to the grid circuit. This is the reversed feedback principle employed in the Tuska Superdyne, which permits the set to take full advantage of tuned plate (resonant) radio-frequency amplification.

For the benefit of our interested readers, and to save them the trouble of communicating with us, we herewith list a few of the more prominent non-radiating receivers.

All forms of radio-frequency amplified sets are non-radiating when properly operated. It is impossible to secure satisfactory reception when they are oscillating. This broad statement completely covers the following:

The Neutrodyne, which is probably the most stable of all R. F. receivers.

The reflex sets De Forest, Grimes, single tube, Erla, Acmedyne, etc.

Receivers having aperiodic primaries, while they radiate to a slight degree, are far less bothersome than other types of regenerative receivers, and, in most cases, they may be used with a clear conscience. This circuit is shown in Fig. 1. The Haynes circuit, which was inadvertently and incorrectly mentioned as a "trick circuit" in the article to which our correspondent refers, is representative of commercial instruments of this type.

The super-heterodyne when used with a loop may be considered as a non-radiating receiver, even though the principle upon which it functions depends on a constantly oscillating circuit. These oscillations, however, are confined to two small coils within the receiver, and for this

reason they are not radiated to any great extent. Even this very small radiation has been practically eliminated on broadcasting wavelengths in Armstrong's latest variation of his original receiver which is called "The Second Harmonic Super-heterodyne." This receiver, rather than using direct oscillations in the neighborhood of the received frequency, employs a widely different main frequency, the comparatively weak second harmonic of which replaces the usual heterodyning wave. This system makes practicable the super-heterodyne on the extremely short waves below one hundred and fifty meters, where, using the main oscillating wave, the radiations, which are

characterized by a remarkable efficiency, would carry fully as far as the lower frequencies now do on the antenna operated "bloopers."

#### THE THEORETICAL "WHY" OF R. F. AMPLIFICATION

*In these advanced days, when radio-frequency amplification is the keynote of wireless reception, I think many of your readers, including myself, would appreciate it if you would clear up a theoretical point that has bothered me for some time.*

*I do not understand how radio-frequency oscillations are passed on from one tube to the next tube. I have always been taught that the plate current, which of course is responsible for the inter-tube transference of energy, is a direct current. Thus it seems to me that a single tube is all that is required to block effectively a high frequency alternating current such as forms a radio signal. And yet it appears that three or four of such tubes do not block or impede the progress of these currents in any way, but to the contrary intensify them. Why?*

B. J. S., NILES, Mich.

THE phenomenon which puzzles our reader is, briefly, how can a vacuum tube, through which only a direct current may flow, pass an alternating current on to the next tube? This is explained by pointing out that the tube does not pass on the original current which was applied to its input side—rather each tube "generates" on its output side an entirely new alternating current, which, however, is an amplified duplicate of the original impressed signal.

The majority of our readers are familiar with the action of the three element vacuum tube, the plate current of which is an electron stream, thrown off by the filament, attracted to the plate by the positive B battery charge, which may be varied by an additional charge placed upon the intervening grid. The slightest variation of the original grid potential either impedes (with a minus variation) or increases (with a plus variation) the plate (or space) current. Thus, when an alternating current, or a radio impulse is impressed on the grid of the tube, which means that the original grid charge is momentarily augmented and lessened, the direct plate current becomes stronger and weaker.

The plate current, after the manner of all currents, sets up in its immediate vicinity a magnetic field, which, if the plate current is made to flow through the primary of a radio-frequency amplifying transformer, will "cut" the secondary. The magnetic field varies with the strength of the current which sets it up, and thus the flux will rise and fall, keeping perfect time with the grid variations. When a magnetic field moves in this manner, an alternating current is set up in any adjacent windings such as the secondary of the amplifying transformer.

This alternating current is now impressed on the input side of the succeeding tube where the process is repeated. Thus each radio-frequency amplifying tube relays an alternating current on to the next audion, without actually passing any of the input current.

#### PHANTOM CIRCUITS AND PHANTOM RECEIVERS

*I read with great interest the article in the March RADIO BROADCAST showing how the old standard circuits are dressed up in deceptive garments by unscrupulous and ignorant dealers.*

*I have been interested in the possibilities of the Oard Phantom Receiver, manufactured by the Oard Laboratories, Stock-*

ton, California. I should appreciate your informing me if this receiver employs the "phantom" circuit described in the article in question.

R. O. M., Milwaukee, Wis.

**N**O. THE circuit employed in the Oard Phantom Receptor is a different one. Moreover, the manufacturers of this receiver do not claim their circuit to be a new one, but distinctly mention in their advertising matter that it is licensed under the Armstrong regenerative patents.

This undesirable association of the Oard Receptor with the "phantom circuit" described in the March RADIO BROADCAST is additionally illustrative of the "gyp" phase of our young industry. Following the national advertising campaign of the Oard people, an unscrupulous concern advertised "the famous Phantom circuit" which, through natural association, cashed in on the Oard advertising.

This commercial plagiarism is found in all varieties of endeavor, but it is particularly malignant in budding industries, such as radio now is. The "Micadyne" condenser is another example of "gyp" enterprise. The "Micadyne" is an obvious and unjust take off on the Dubilier "Micadon," and a permanent injunction has been issued enjoining the counterfeiters from manufacturing the "Micadyne."

The radio enthusiast will find many other misleading trade similarities. He should discover, if he can, the original product or prototype, and beware of the imitation. An honest product will stand on its own legs—and an honest manufacturer does not stoop to camouflage or deception.

"Accept nothing but the genuine", has been applied to everything from pills to suspenders, but in no industry should this warning be taken more seriously than in radio.

#### WHEN IS MY SET OSCILLATING?

*I have a three-circuit regenerative receiver which I understand should not interfere with my neighbors as much as would a single-circuit set. However, another fan, living next door to me, claims that he hears me when my set is oscillating. I have no desire to interfere with his pleasure, and am always unaware of the fact when my set is radiating. Is there any way that you can tell definitely when a set is oscillating?*

A. T. R., Roswell, N. M.

**I**T IS often difficult for the untrained radio ear to determine when a circuit is oscillating. However, you may be certain that you are causing trouble when, as you tune across the wave of the broadcasting station, a whistle is audible that varies directly with your tuning.

A sure test for oscillations is touching either the grid connection of the tube, or the antenna binding-post. A

slight click or scratch will always be audible when this is done, but a much more definite "blop" will be heard if the circuit is oscillating. However, touching the antenna post only affects the first tube, and the grid connection should be touched when testing radio-frequency amplifiers, difficulty with which is often caused by one or more of the tube circuits falling into oscillation.

Oscillations are controlled in most receivers by turning down the filament and by reducing regeneration. In radio-frequency stages, they are generally eliminated by potentiometer adjustment, reduction of filament current, and by reducing the plate voltage.

#### A. C. AND D. C. CHARGERS

*Is there any difference in storage battery chargers operating from the house lighting lines, as determined by whether the user is supplied with alternating or direct current?*

A. L. J., New York City.

**Y**ES, there is all the difference in the world. A charger designed for alternating or direct current will operate only on the current supply for which it was intended. A direct current charger, connected to an alternating current source, will not charge, while an A. C. charger connected to direct current mains will burn out its primary winding, or blow fuses.

Direct current for charging need only be reduced to the proper voltage, while alternating current must be reduced and then rectified to direct current. Direct current voltages are generally reduced by the inclusion in the circuit of a suitable resistance. The Ward-Leonard direct current charger is an excellent example of this type of apparatus.

Alternating current chargers consist of step down transformers for re-

#### ABOUT YOUR GRID

Judging from the rapidly increasing demands made upon this section, it is performing a valuable service—but it is getting to be a very serious problem.

As a general rule replies to letters addressed to the GRID require the drawing of a diagram or two and a considerable amount of research. Similar service, if purchased elsewhere, would cost a very tidy sum. We are pleased to offer this service to our readers without charge but feel that it is up to our readers to cooperate with us to the extent of sending, with their requests for information, a self-addressed, stamped envelope. Unless our request is complied with the GRID will be unable to consider these inquiries.—THE EDITOR.

# Improve your set with an ★ ACME "lowest loss" condenser

*Because of low losses and sharp tuning practically all the currents on the antenna can now be used*

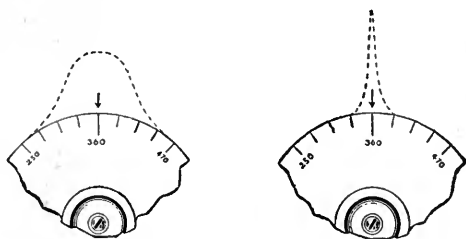

Which one is your  
tuning circuit—  
*the hump or peak?*

**H**ERE are the curves of two tuning circuits. The hump has a high loss condenser and the peak a low loss condenser. Both receive broadcasting, but the peak receives local and distant stations without interference, while the hump receives only the nearby stations with interference. The new Acme Condenser will change your tuning circuit from a hump to a peak.

The Acme Engineers have been working for two years to bring out a condenser which would give to Radio experimenters sharp tuning and minimum losses. The new Acme Condenser has these fundamental advantages and also has many new improvements in structure and equipment. See the illustration with explanation, and for more information write to us for booklet—"Amplification without Distortion," which contains many diagrams and helpful hints on how to build and get the most out of a set.

ACME APPARATUS COMPANY  
Dept 65 Cambridge, Mass

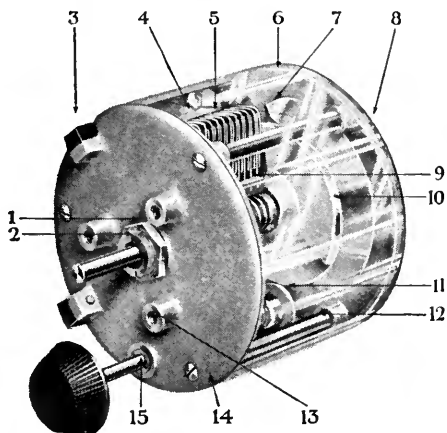

1. Steel brass cone bearings adjustable.
2. Lock nut for bearing.
3. Highest grade hard rubber Dielectric in that part of the field to prevent losses
4. Brass separator to which both rotary and stationary plates are soldered, making continuous circuit for each.
5. Brass silver plated plates, rotary plates logalarithmic.
6. Dust proof covering
7. Stops at extreme end of movements
8. Coiled connection between shaft and heads allowing lubrication of bearings.
9. Brass separator to which both rotary and stationary plates are soldered, making continuous circuit for each.
10. Counterweight which balances rotary plates
11. Noiseless friction Vernier control seven to one ratio.
12. Brass separators to prevent twisting and to take strain off Dielectric
13. Panel mounting holds for 120 degrees spacing.
14. Metal heads
15. Steel bushing to prevent wear on Vernier shaft.

All parts are of non-rusting metal, except steel bearing, which is covered with nickel-plated protective surface. End plate capacity is .000016 m.f. full capacity is .0005 m.f. Price \$6.50

CUT OUT AND SEND THIS COUPON

ACME APPARATUS COMPANY,  
Dept 65 Cambridge, Mass. U S A

Gentlemen: I am enclosing 10 cents (U S. stamps or coin) for a copy of your book, 'Amplification without Distortion.'

Name .....

Street .....

City..... State.....

# ACME ~for amplification

★ Tested and approved by RADIO BROADCAST ★





© Harris & Ewing

WALLACE H. WHITE, JR.

The author of the bill which proposes further to regulate radio communication in the United States. Among other things the bill contains stringent provision against monopoly in radio and provides for license fees to be collected by the Department of Commerce, ranging from \$300 for transatlantic stations to fifty cents for an amateur license. Owners of receiving sets are not subject to a charge. Mr. White represents the second Congressional District of Maine