

RADIO'S GREATEST MAGAZINE

February

OVER 175 ILLUSTRATIONS

HUGO
GERNSBACK
EDITOR

25 Cents
United States
Canada

Radio-Craft



This Home
WIRED FOR RADIO
SPONSORED BY
Radio-Craft
MAGAZINE



See Page 460

Dr. Lee deForest: "Broadcasting As I Imagined It" • Unique Sound Effects
Making the "Lunchbox 5" Battery Portable • Killing the "Intermittent" Bug

OVER 50,000 RADIO MEN READ RADIO-CRAFT MONTHLY

3 TUBE KIT

**IT'S FUN TO BUILD IT
IN ONE EVENING!**

These new Meissner Kits are remarkable little radio receivers—efficient in operation—and very easy to assemble.

This 3-Tube Model will operate a magnetic or permanent-magnet speaker. Utilizes the very last word in battery set engineering—the 1½-volt series of tubes! Has three controls—tuning, regeneration and volume.

Each Kit comes to you in a package—complete with all parts necessary for the construction of a complete receiver including panel, chassis, sockets, resistors, condensers, wire, hardware and a broadcast band plug-in coil. Does not include tubes, batteries or speaker.

*And it is guaranteed to work or
Meissner will fix it for you!* **\$375**

2-TUBE KIT!

Same as Model described above except no volume control. Operates a headphone. **\$300**

1-TUBE KIT!

A practical little 1-Tube receiver that really works. Looks like the illustration except no volume control. Operates a headphone. **\$270**

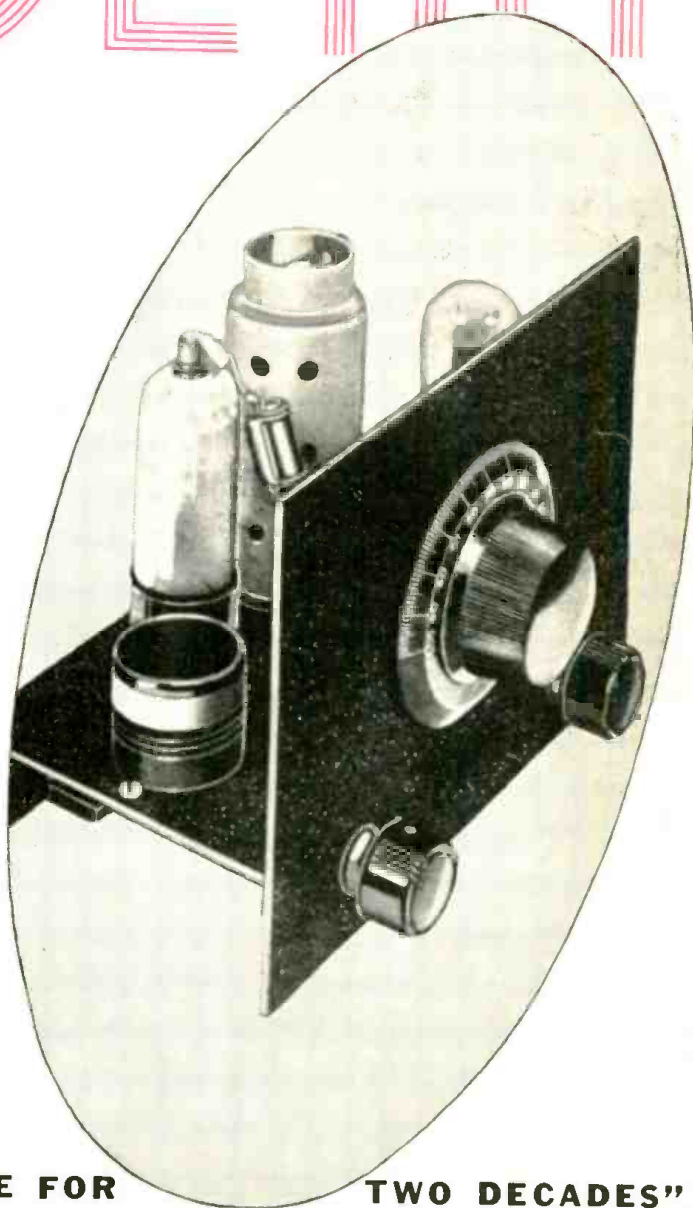

“A FAMOUS NAME FOR TWO DECADES”

MAIL COUPON!

MEISSNER MFG. CO., Dept. RC-2
Mt. Carmel, Illinois

Please rush me information on

- 3, 2 and 1-Tube Kits
 Larger Kits

Name

Address

City State

ASK YOUR PARTS JOBBER

Meissner

MT. CARMEL, ILL.

Put Yourself on RADIO'S PAYROLL

LEARN AT HOME IN SPARE TIME TO BE A RADIO EXPERT



(Above) SET SERVICING pays good money to N.R.I. Graduates—either for full time or spare time work.



(Below) AVIATION, Commercial, Marine, Police Radio are other fields that have given good jobs to N.R.I. graduates.



(Above) BROADCAST STATIONS: Many of my graduates are employed in fascinating, good pay jobs as operators, engineers, etc. (Below) LOUD-SPEAKER SYSTEMS: Many N.R.I. men make good money in P.A. work.

Make Me Prove that My Training will fit You to Make GOOD MONEY IN RADIO



J. E. SMITH, President National Radio Institute Established 1914

I will send a sample lesson FREE. Examine it, read it, see how clear and easy it is to understand—how practical I make learning Radio at home. Then you will know why men without a knowledge of Radio or electricity have become Radio Experts and are earning more money than ever as a result of N. R. I. Training.

Get My Lesson on Radio Servicing TIPS FREE

My lesson text, "Radio Receiver Troubles—Their Cause and Remedy," covers a long list of radio receiver troubles in A.C., D.C., battery, universal, auto, T.R.F., super-heterodyne, all-wave, and other types of sets. And a cross-reference system gives you the probable cause and a quick way to locate and remedy these set troubles. A special section is devoted to receiver check-up, alignment, balancing, neutralizing, testing. You can get this lesson free by mailing the coupon.

Why Many Radio Experts Make \$30, \$50, \$75 a Week

Radio broadcasting stations employ engineers, operators, station managers and pay up to \$5,000 a year. Fixing Radio sets in spare time pays many \$200 to \$500 a year—full time jobs with Radio jobbers, manufacturers and dealers as much as \$30, \$50, \$75 a week. Many Radio Experts open full or part time Radio sales and repair businesses. Radio manufacturers and jobbers employ testers, inspectors, foremen, engineers, servicemen, and pay up to \$6,000 a year. Automobile, police, aviation, commercial Radio, loud speaker systems are newer fields offering good opportunities now and for the future. Television promises to open many good jobs soon. Men I trained have good jobs in these branches of Radio. Read how they got their jobs. Mail Coupon.

Many Make \$5, \$10, \$15 a Week Extra in Spare Time While Learning

The day you enroll I start sending Extra Money Job Sheets: show you how to do Radio repair jobs. Throughout your training I send plans and directions that make good spare time money—\$200 to \$500—for hundreds, while learning. I send you special Radio equipment to conduct experiments and build circuits. This 50-50 method of training makes learning at home interesting, fascinating, practical.

I Also Give You This Professional Servicing Instrument

Here is the instrument every Radio expert needs and wants—an All-Wave, All Purpose, Set Servicing Instrument. It contains everything necessary to measure A.C. and D.C. voltages and current; to test tubes, resistance; adjust and align any set, old or new. It satisfies your needs for professional servicing after you graduate—can help you make extra money fixing sets while training.



Get Sample Lesson and 64-Page Book FREE, Mail Coupon

In addition to my Sample Lesson, I will send you my 64-page book, "Rich Rewards in Radio." Both are FREE to anyone over 16 years old. My book points out Radio's spare time and full time opportunities and those coming in television; tells about my Training in Radio and Television; shows you letters from men I trained, telling what they are doing and earning; shows my Money Back Agreement. MAIL THE COUPON in an envelope, or paste it on a penny post card.

J. E. Smith, President NATIONAL RADIO INSTITUTE Dept. 9BX Washington, D. C.

GOOD FOR BOTH 64 PAGE BOOK FREE

J. E. SMITH, President, National Radio Institute, Dept. 9BX Washington, D. C.

Without obligating me, send your Lesson "Radio Receiver Troubles—Their Cause and Remedy" and free book about spare time and full time Radio opportunities and how I can train for them at home in my spare time. Tell me about the N.R.I. Set Servicing Instrument you include. I am particularly interested in the branch of Radio checked below.

- | | |
|---|--|
| <input type="checkbox"/> Radio Service Business of My Own | <input type="checkbox"/> Loud Speaker Systems, Installations and Service |
| <input type="checkbox"/> Spare Time Radio Service Work | <input type="checkbox"/> Auto Radio Installation and Service |
| <input type="checkbox"/> Retail Sales of Radio Sets and Equipment | <input type="checkbox"/> Television Station Operator |
| <input type="checkbox"/> Service Expert for Retail Stores | <input type="checkbox"/> Service Expert with Radio Factory |
| <input type="checkbox"/> Broadcasting Station Operator | <input type="checkbox"/> Commercial Radio Station Operator |
| <input type="checkbox"/> Aviation Radio Operator | <input type="checkbox"/> All-around Servicing Expert |

(If you have not decided which branch you prefer—mail coupon now; for information to help you decide.)

Name Age

Address 14x1



(Above) YOUR OWN BUSINESS: Many men I trained operate successful Radio sales and service businesses.



Radio-Craft

FOR THE
SERVICE MAN · DEALER · RADIOTRICIAN

HUGO GERNSBACK, *Editor-in-Chief*

N. H. LESSEM
Associate Editor

THOS. D. PENTZ
Art Director

ROBERT EICHBERG
Trade Digest Editor

R. D. WASHBURNE, *Managing Editor*

Contents FEBRUARY, 1939 Issue

VOLUME X -- NUMBER 8

Editorial: Radio Dumping.....	Hugo Gernsback 453
The Radio Month in Review.....	454
Unique Sound Effects.....	R. D. Washburne 456
Uncle Sam's Radio Studios.....	458
Radio Helps Fight Air-Raids!.....	Michael Norton 459
This Home—"Wired for Radio"—Part II.....	N. H. Lessem 460
Broadcasting—as I Imagined It . . .	Dr. Lee de Forest 462
Newest-Type Wireless Phonograph . . . with Microphone.....	463
Build the "Lunchbox 5" Battery Portable.....	G. E. Archenbronn 464
Play Talkies Through Your Radio Receiver—Part II.....	Jack Robins 466
Complete Step-by-Step Dynamic Servicing—Part II.....	Kendall Clough 468
Killing the "Intermittent" Bug.....	Harl O. Piety 470
New Circuits in Modern Radio Receivers—No. 17.....	F. L. Sprayberry 472
"HQ-120-X" Shortwave Receiver.....	473
Making a Serviceman's Test Unit—The "Super-Geno-Scope"—Part III	Canio Maggio 474
Is Public Address Equipment Overrated?.....	Arthur W. Niemann 476
Operating Notes	477
The Latest Radio Equipment.....	478
Radio Trade Digest.....	479
Servicing Questions & Answers.....	483
 RADIO SERVICE DATA SHEETS:	
No. 245—RCA Victor High-Fidelity Models HF-2, HF-4 and U-130	484
No. 246—Ditto	485
No. 247—Ditto	487
Recent F.C.C. Rulings on "Wireless" Devices.....	501
Book Review	512

In the
NEXT ISSUE

World-Wide Television

How to Make Your Own
Home Talkies—by C. A.
Tuthill

Practical Servicing Pointers
—Willard Moody

Hollywood Turns to Radio!

★
OUR COVER . . .

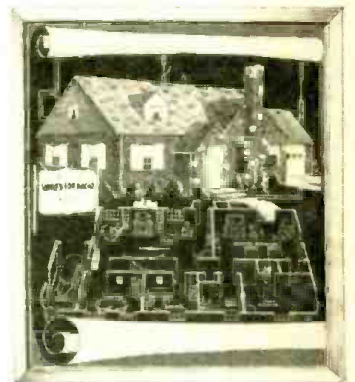

. . . from an oil painting of an artist's conception of the *Radio-Craft* "Radio Home" now nearing completion in Teaneck, N. J. See pg. 460.

★

Published by Radcraft Publications, Inc.
Publication office: 29 Worthington Street,
Springfield, Mass. Editorial and Advertising
Offices: 99 Hudson Street, New York City.
Chicago Advertising Office: RADIO-
CRAFT, 520 North Michigan Avenue, Chi-
cago, Ill.

RADIO-CRAFT is published monthly, on
the first of the month preceding that of
date; subscription price is \$2.50 per year
in U. S. and Canada. (In foreign countries,
\$3.00 a year to cover additional postage.)
Entered at the post office at Springfield as
second-class matter under the act of
March 3, 1879.

Foreign Agents:

London—Gorrings's American News Agency,
9A Green St., Leicester Square, W. C. 2, Eng-
land.
Paris—Messageries Dawson, 4 Rue Faubourg,
Poissonniere, France.
Melbourne—McGill's Agency, 179 Elizabeth
St., Australia.
Dunedin—James Johnston, Ltd., New Zealand.

★

Text and illustrations of this magazine are
copyright and must not be reproduced
without permission of the copyright owners.

★

Copyright 1938 Radcraft Publications, Inc.



H. C. Lewis

QUICK, EASIER WAY TO TRAIN FOR RADIO 12 Weeks Practical WORK IN MY CHICAGO SHOPS

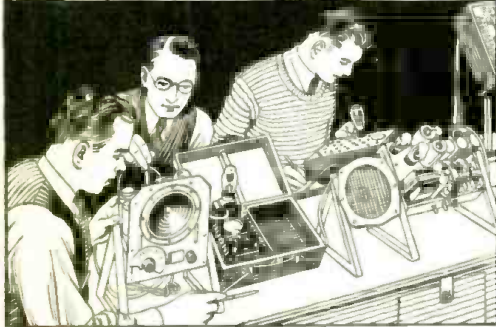

FIRST—You are told and shown how to do it.

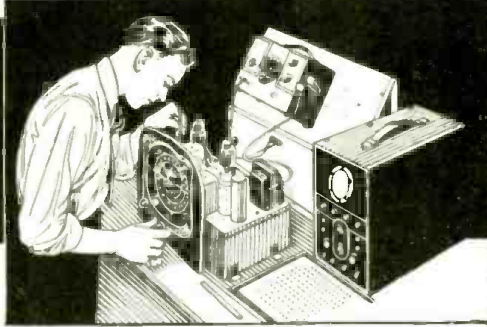

THEN—You do the job yourself.

WANT TO EARN MORE MONEY?

Have you ever dreamed of holding down a steady, good pay job? Have you ever dreamed of doing the work you really like in a job that holds promise of a real future in the years ahead?

Well, we all know that you can't get the good things in life by just dreaming about them. Hundreds of fellows are today holding down mighty fine jobs with prospects of a bright future. They are filling these jobs because they had the foresight to equip themselves with the right kind of training. Most of these men were only average fellows a short time ago, but the proper training helped to lift them out of the low pay ranks of unskilled workers. The same opportunity is now offered to you.

The great fascinating field of RADIO offers a real future to many men and young men who are willing to prepare for a place in this giant industry.

Here at my school in Chicago, the world's Radio Center, you can get 12 weeks' Shop Training in RADIO AND TELEVISION, that can help give you your start towards a better job.

You will be trained on actual equipment and

I'LL FINANCE YOUR TRAINING

You can get this training first—then pay for it later in easy monthly payments, starting 60 days after your 12 weeks' training period is over—then you have 12 months to complete your payments.

If you need part time work to help out with expenses while training in my shops, my employment department will help you get it. Then after graduation this department will give you valuable lifetime employment service.

Send the coupon today for all details. When I get it I'll send you my big free book containing dozens of pictures of students at work

H. C. LEWIS, President

COYNE ELECTRICAL SCHOOL

RADIO DIVISION

500 S. Paulina St., Dept. 29-8H, Chicago

machinery and because of our method of training, you don't need previous experience or a lot of education. Many of my successful graduates never even completed Grammar School.

PRACTICAL WORK at COYNE in CHICAGO

ACTUAL, PRACTICAL WORK. You build and service radio sets. You get training on Real Broadcasting equipment. You construct Television Receiving Sets and actually transmit your own Television images over our Television equipment. You work on real Sound equipment. You learn Wireless Operating on Actual Code Practice apparatus. We don't waste time on useless theory. We give you the practical training you'll need for your start in Radio, in 12 short weeks. If you desire code, this requires additional time for which there is no extra charge. I also include instruction in Electrical Refrigeration at no extra cost. Our practical shop methods make it easier to learn—First the instructors tell you how a thing should be done—then they show you how it should be done—then you do the actual work yourself.

in my shops. I'll also tell you about my "Pay After Graduation" plan, how many earn while learning and how we help our students after graduation. Fill in, clip coupon, mail it today for your start toward a brighter future.



TELEVISION
You work on actual equipment



SOUND TRUCK
Learn to install Public address systems



"...Everything was just as stated in literature. And by Coyne methods plenty of instructors take care of everything, easy to learn. I really was satisfied with Coyne Training."
J. Halyk, Canada

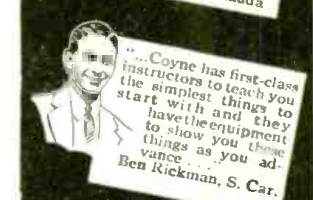

"...Coyne has first-class instructors to teach you the simplest things to start with and they have the equipment to show you these things as you advance."
Ben Kickman, S. Car.



H. C. LEWIS, President
COYNE ELECTRICAL SCHOOL—RADIO DIV.
500 South Paulina Street, Dept. 29-8H, Chicago, Ill.

Dear Sir: Please send me free your big catalog and full particulars of your present offer, also your "Pay-Tuition-After-Graduation" Plan.

NAME _____
ADDRESS _____
CITY _____ STATE _____

For Better Servicing - - For Greater Profits - - Use Gernsback Manuals and Books!

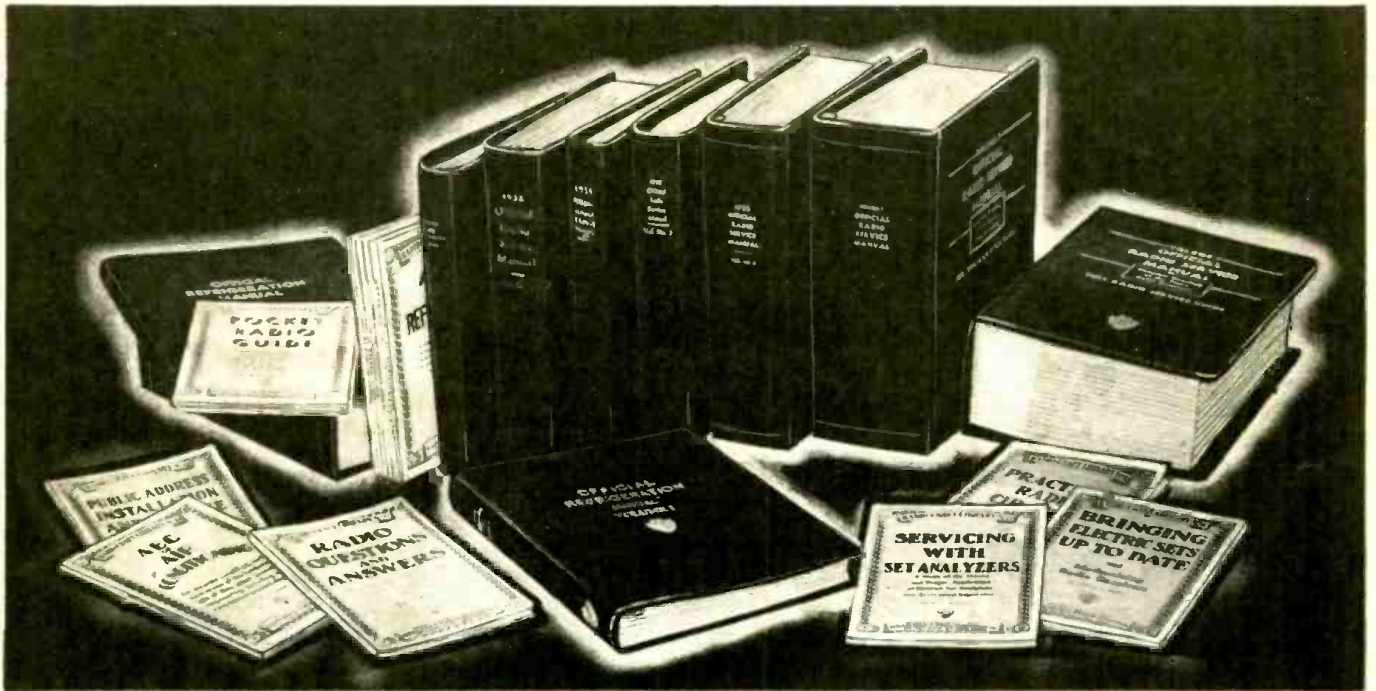

SINCE 1931 Servicemen have been buying more GERNSBACK OFFICIAL RADIO SERVICE MANUALS year after year. The authentic material, easily accessible diagrams and complete service data make them invaluable to dealers and radio Servicemen. Without a Gernsback Service Manual on the repair job, there's time and profit lost. Your service kit or laboratory is incomplete without all the GERNSBACK OFFICIAL RADIO SERVICE MANUALS. There are GERNSBACK MANUALS for servicing auto-radios, also refrigeration and air conditioning equipment.

VOLUME 7 OFFICIAL RADIO SERVICE MANUAL

Over 1,800 Pages • Over 3,000 Illustrations • Stiff, Leatherette, Looseleaf Covers • Size 9 x 12 Inches • Net Weight 10½ lbs. **\$10.00**

1936 OFFICIAL RADIO SERVICE MANUAL

Over 1,200 Pages • Over 2,500 Illustrations • Stiff, Leatherette, Looseleaf Covers • Size 9 x 12 Inches • Net Weight 8 lbs. **\$7.00**

1935 OFFICIAL RADIO SERVICE MANUAL

Over 1,000 Pages • Over 3,000 Illustrations • Flexible, Leatherette, Looseleaf Covers • Size 9 x 12 Inches • Net Weight 3¾ lbs. **\$7.00**

1935 OFFICIAL AUTO-RADIO SERVICE MANUAL

Over 240 Pages • Over 500 Illustrations • Flexible, Leatherette, Looseleaf Covers • Size 8 x 12 Inches • Net Weight 1½ lbs. **\$2.50**

1934 OFFICIAL RADIO SERVICE MANUAL

Over 400 Pages • Over 2,000 Illustrations • Flexible, Leatherette, Looseleaf Covers • Size 9 x 12 Inches • Net Weight 2¼ lbs. **\$3.50**

1932 OFFICIAL RADIO SERVICE MANUAL

Over 1,000 Pages • Over 2,000 Illustrations • Flexible, Leatherette, Looseleaf Covers, Size 9 x 12 Inches • Net Weight 4¼ lbs. **\$5.00**

OFFICIAL REFRIGERATION SERVICE MANUAL

(Volume I)

Over 450 Pages • Over 1,200 Illustrations • Flexible, Leatherette, Looseleaf Covers, Size 9 x 12 Inches • Net Weight 2¼ lbs. **\$5.00**

OFFICIAL REFRIGERATION SERVICE MANUAL

(Volume II)

Over 350 Pages • Over 500 Illustrations • Flexible, Leatherette, Looseleaf Covers, Size 9 x 12 Inches • Net Weight 1½ lbs. **\$5.00**

OFFICIAL AIR CONDITIONING SERVICE MANUAL

Over 350 Pages • Over 600 Illustrations • Flexible, Leatherette, Looseleaf Covers, Size 9 x 12 Inches • Net Weight 1½ lbs. **\$5.00**

To order these famous Manuals, see or write to your jobber or favorite mail order house. If more convenient, mail coupon directly to publishers.

RADCRAFT PUBLICATIONS, Inc.
99 HUDSON STREET NEW YORK, N. Y.

THE RADIO-CRAFT LIBRARY SERIES

Get into the swing of reading instructive, authoritative books on technical subjects—radio, air conditioning and refrigeration. It's the easiest, quickest and most inexpensive way to improve your knowledge on these topics. In this series, popularly known as the RADIO-CRAFT LIBRARY SERIES, are all the titles necessary to your personal advancement. Only by careful study of these enlightening books, can you gain adequate experience in fields of radio, air conditioning and refrigeration. Each book is uniform. The volumes measure 6 x 9 inches—contain 64 pages, and have stiff, flexible covers. PRICE 50c PER BOOK. All books are sent to you postpaid.

Here Are The Titles:

- | | |
|--|---|
| Book No. 2
MODERN VACUUM TUBES | Book No. 14
POCKET RADIO GUIDE |
| Book No. 3
THE SUPERHETERODYNE BOOK | Book No. 15
ABC OF REFRIGERATION |
| Book No. 6
BRINGING ELECTRIC SETS UP-TO-DATE | Book No. 16
PRACTICAL RADIO CIRCUITS |
| Book No. 9
AUTOMOBILE RADIO AND SERVICING | Book No. 17
SERVICING WITH SET ANALYZERS |
| Book No. 10
HOME RECORDING AND ALL ABOUT IT | Book No. 18
POINT-TO-POINT RESISTANCE ANALYSIS |
| Book No. 12
PUBLIC ADDRESS INSTALLATION AND SERVICE | Book No. 20
THE CATHODE-RAY OSCILLOSCOPE |
| Book No. 13
ABC OF AIR CONDITIONING | Book No. 21
BREAKING INTO RADIO SERVICING |
| | Book No. 22
NEW RADIO QUESTIONS AND ANSWERS |

EACH BOOK IN THIS SERIES—50c

RADCRAFT PUBLICATIONS, Inc., 99 HUDSON ST., NEW YORK, N. Y.

Gentlemen: Enclosed find my remittance of \$..... for which send me, POSTPAID, the Manuals or Books indicated below by a cross (x) in the Panel.

- () Volume 7 @ \$10.00 () 1936 Manual @ \$7.00 () 1935 Manual @ \$7.00
 () 1935 Auto-Manual @ \$2.50 () 1934 Manual @ \$3.50 () 1932 Manual @ \$5.00
 () Refrigeration Manual (Vol. I) @ \$5.00 () Refrigeration Manual (Vol. 2) @ \$5.00
 () Air Conditioning Manual @ \$5.00

RADIO-CRAFT LIBRARY SERIES @ 50c EACH

Circle book numbers wanted: 2 3 6 9 10 12 13 14 15 16 17 18 20 21 22

Name Address

City State

(Send remittance in form of check or money order; register your letter if you send cash or unused U. S. Postage Stamps.)

RC-239



' TAKES THE RESISTANCE OUT OF RADIO '

RADIO DUMPING

By the Editor — HUGO GERNSBACH

EVER since Radio started, long before we had radio receivers and when the only radio business was the parts business, the radio industry was beset by the "dumping" problem. It has been with us ever since.

In those days, particularly when the radio boom started in the early '20's a radio parts manufacturer would get a bright idea, let us say for a new type of radio condenser. He would manufacture 50,000 or 100,000 of them and sell a good many during the Season. Then suddenly someone else would come along and make a different condenser that was thought to be more up-to-date. Immediately the first condenser became obsolete and sales through normal channels and at popular prices rapidly declined; so in order to get at least part of his investment back, the manufacturer would dump the condenser, often below cost price, to get rid of it and salvage at least part of his investment. This sort of thing has kept up ever since and the evil is still with us.

There are few parallels in modern industry that can show such a record where year after year an industry throws upon the market its product to be sacrificed at whatever it may bring. The situation is one that is difficult, if not wholly impossible to eradicate, because of all modern, 20th Century machine age products, the radio receiver of today undergoes more violent and more radical changes than almost any other single item we can think of.

Perhaps the nearest parallel product is the automobile which also undergoes many changes year by year, but for some reason or other the automobile industry as a whole is not so much concerned with the dumping problem as is the radio industry. For one thing, an automobile is a much more expensive item, secondly prices are not openly slaughtered as are radio prices and if any so-called "dumping" is attempted at all it is usually accomplished by allowing the purchaser of a new, but last year's model car, a larger trade-in value on his present car.

Many manufacturers in the radio set industry today do not resort to such subtleties, but when they become convinced that their radio receiver is no longer saleable through regular channels the surplus is simply dumped on the market through the jobbing and retail trade for whatever prices they will bring.

This condition particularly becomes aggravated when a number of manufacturers attempt drastic changes. Years ago the radio receiver had as many as 10 controls on the front panel—all of which you had to manipulate in order to get your station. Everyone was happy, until one manufacturer came out with a set that had only 2 or 3 controls. Naturally the public took kindly to this type of set, which immediately sounded the death knell of the other sets not so equipped. This "dog eat dog" process has gone on ever since and will probably go on for a long time to come. When, for instance, the radio sets last year came out with *pushbutton control* there was a stampede by practically all manufacturers for pushbutton control. This immediately made the other sets that had no such control obsolete and they in turn had to be dumped for whatever they could bring. If the trend for the coming year will be remote "wireless" control then the pushbutton control sets in turn will become obsolete.

Of course, in many quarters the radio industry tries to emulate the automobile industry by doing away with the price slaughtering and making larger allowances for traded-in sets but this procedure has not been wholly satisfactory for the reason that the radio sets, unlike automobiles, do not wear out as rapidly and hence a radio receiver will give excellent results—at least to its owner—even if it is 5, 6 and even 10 years old.

While the owner's present set may sound "tinny" with its old rattling speaker, he does not appreciate this unless a new set were demonstrated alongside his present one to make him understand how far radio has traveled in the short space of a few years. Moreover, many radio set owners have a good investment in their old sets which may be anything from \$50 to \$250; meanwhile he has become used to his set and thinks there is nothing like it and is loathe to part with it. There is, therefore, a strong buyers' resistance in radio sets, which is not so much the case in automobiles. It is certain that the average radio set in the homes of America is considerably older by many years than the average automobile on the road today.

It is, of course, also true that the public at large benefits by the "dumping" policy of the radio manufacturers and it enables the public to buy really first-class radio receivers at often unheard-of prices—and in a good brand, to boot.

Having become educated to this price-cutting policy, only the well-to-do buy the latest sets, whereas the average man waits until the price comes down, which it usually does by the end of the season. Then he picks up the set on which he has had his eye at a price that he can afford to pay; meanwhile, and for several years, he will have a real good receiver, even if it is not equipped with the latest gadgets, and he will be happy with his purchase.

The real loser in the transaction is, of course, as usual the Radio Industry and this is the reason why today there are not many manufacturers in the ranks of the radio set industry that can show the yearly profit to which they are clearly entitled. It is also the reason that whereas during the radio boom, when we had several hundred radio set manufacturers, today we have only a mere handful of the larger manufacturers who have been able to stand their own destructive "dumping" policy.

What is the answer to the problem? To me it seems that the radio set manufacturers, with only a few notable exceptions, have not made the most of their obvious means of propaganda for their own product and that is, most astonishingly, the thing that should be most dear to their hearts. I refer to Radio Broadcasting. The public, who by the millions is listening-in today on obsolete receivers, is not made sufficiently aware of this fact through specialized programs that would show up the defects of their radio sets—*immediately*. The printed advertisement can only go so far but when radio receiver technicians get together with broadcast engineers, they CAN in turn provide special programs of the type to show up immediately the obvious defects in a large percentage of radio sets—and right in the set-owner's own home.

This to me seems to be the best solution because it will educate the public to buy more and better receivers, and cure a great deal of the *DUMPING EVIL*.

THE RADIO MONTH



LISTENING FEET!

Last month Miss Helen Keller—deaf, dumb and blind since childhood—"heard" the N.B.C. Symphony Orchestra perfectly through her feet. The spring-suspended studios are acoustically "dead," but a wooden sounding-board platform on the studio's floor enabled Miss Keller to sense the beauty of the entire performance, which was conducted by Arturo Toscanini. Her companion, Miss M. A. Thompson (left), carries on conversations with Miss Keller merely by hand-pressure.

package tossed out, floodlights on the rear platform of the last car were lighted. The engineer was signaled to whistle twice, whereupon the airplane dived at the floodlighted location and the plane's radio operators flashed directions to squad cars. The first squad car to reach the scene quickly found a parked car. Two men walking toward the car from the railroad tracks were captured.

Bell Labs.' coaxial cable to Princeton last month passed with flying colors a talk-back test that beats all previous conversation efforts. Satisfactory test conversations were held over a circuit 2,100 miles in length, built up by looping back and forth through the coaxial system a total of 20 times.

This circuit consisted of 4 voice-frequency links in tandem. The conversation passed through 64 steps of modulation in each direction, using channels located in different parts of the frequency band between 100 and 1,900 kc., and passed 20 times through each amplifier, giving the equivalent of 420 amplifiers in each direction. Result: simulation of a transcontinental coaxial cable.

John Heizer, a Stanford University engineering student, carries a portable ultra-violet ray machine on his meteorological expeditions in the Nevada mountains, a report last month stated. Tungsten ore fluoresces (glows) when subjected to U.V. rays.

Western High School, Detroit, Mich., last month introduced what is believed to be a unique course of study on the

high-school level—a course on radio (and talking motion pictures), according to *Radio Daily*.

According to a release from Finch Telecommunications Laboratories, Inc., last month, station W2XBF of W. G. H. Finch, and located in New York City, is the first of the duplex type employing both amplitude and frequency modulation. Both voice and facsimile programs will be transmitted simultaneously.

Patent No. 484,944 has just been granted in the United Kingdom to W. G. H. Finch for a new high-speed facsimile system for radio or wire use which is directly applicable for actuating an engraver for directly cutting zinc plates for printing presses, etc.

In recognition of his pioneer work on wave antennas and his continued work in this and other phases of the radio art, the award of the Armstrong Medal by the Radio Club of America was made to Harold Henry Beverage, last month. Beverage's first amateur station was built in 1910. The precursor of wave antennas of all types is his development.

Last month, 60 G.E. engineers participated in a survey which served as the basis of an article, by Dr. C. G. Suits, published in the *G.E. Review*. It seems that Mr. Average Engineer spends about 12 hours per week on his hobby (be it what it may), spends \$130 per year and admits that his hobby has influenced the choice of his vocation.

Radio was the most commonly abandoned hobby.

(Continued on page 486)

MISCELLANEOUS

RADIO helped Federal Bureau of Investigation agents nab 2 alleged extortionists last month who had threatened to kill a young socialite and his mother unless \$20,000 was forthcoming.

The F.B.I. boys, according to a U.P. report, had a plane flying over the train from which the contact man was to toss a package containing money at the signal of a white flag. When the flag's signal was spotted and a dummy

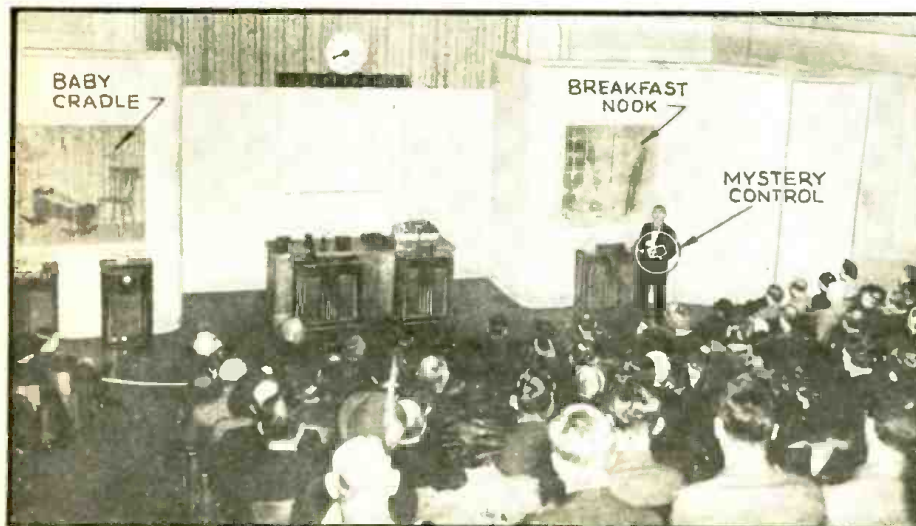

HOUSEHOLD "MYSTERY ROBOT"

Chief Cook and Bottle-Washer at Franklin Institute (Phila., Pa.), last month, was Philco's telephone-dial-like "Mystery Control." The 700 attendees at this first Remote Control Show were shown that, at one setting of the dial, baby could be rocked to sleep (cubicle at upper-left in photo); and that, at another, this "Mystery Robot" could cook eggs, "perk" coffee, and make toast (upper-right). Even the spot-lights, etc., were remote-controlled!



ELECTRON MICROSCOPE

Radio-Craft last month received this illustration of the new Siemens & Halske (Berlin, Germany) "super-microscope." Magnification up to 30,000 times, with an anode voltage of 100,000, is obtained by employing the principle of "electron optics."

IN REVIEW

BROADCASTING

THE Nazi regime paid Jewry one of its highest compliments last month when, according to an *A.P.* report, Nazis requisitioned radio sets in Jewish homes. The Nazi explanation was that "Radio is a matter of German culture and is nothing for Jews." But radio, you see, is based on the original work of Heinrich Hertz—a Jew!

Shades of Emily Post! Station KOIL now penalizes employees real cash for infraction of etiquette as follows: intentionally dropping ashes on floor, 10c; smoking in studio, 25c; dropping lighted cigarette or cigar on floor, \$1.00, we learned last month.

Crying need is for a course in how to listen to radio programs, it would seem from remarks last month by I. Keith Tyler, assistant professor and research associate in the Bureau of Educational Research, Ohio State University, speaking at the 84th annual convention of the New Jersey Teachers Association.

He said, "Our loudspeakers pour out a withering barrage of political, economic and social propaganda; a flood of verbose sales talk and great quantities of mediocre clap-trap. Boys and girls are now listening to the radio more than 2 hours a day. To withstand clever psychological sales appeal requires consumer education."

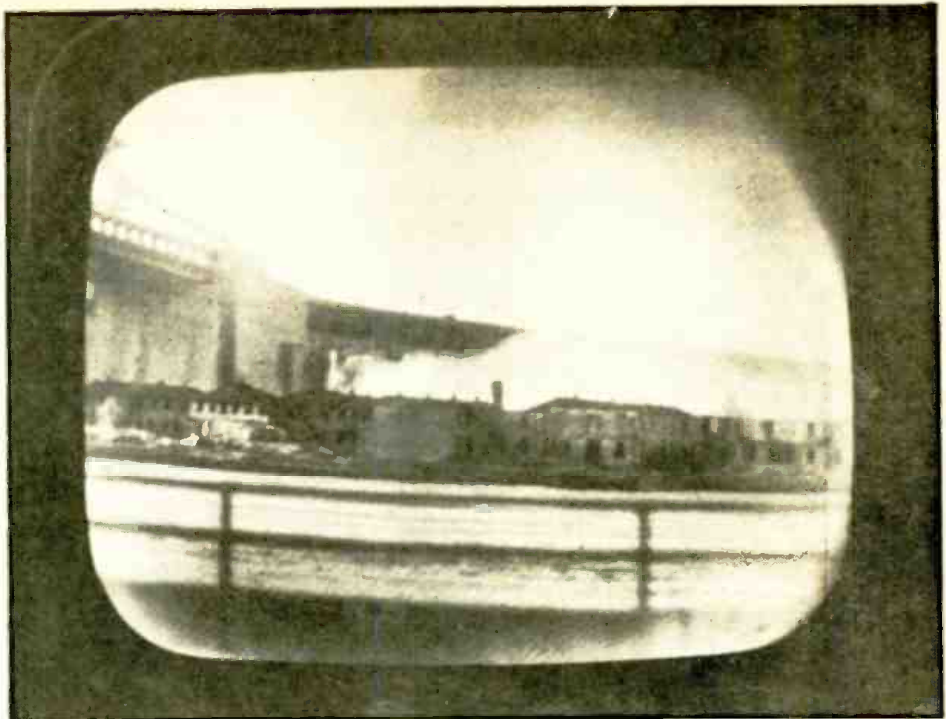

WARD'S ISLAND BLAZE TELEVISED!

Television Reporters went to their first fire, last month, when N.B.C. television engineers, making experimental image pick-ups from the new Astoria (L. I.) swimming pool, spotted a fire on Ward's Island. The above unretouched photo of the fire in progress, aside from its historic and news interest, is important to technicians as illustrating the fidelity achieved in a *television relay*; bear in mind that the "image fidelity" (the view) is much greater than the "picture fidelity" (the photograph). The telemobile unit transmitted the scene via shortwaves to the Empire State Building; from there it went via a second short-wave channel to television receivers at Radio City, where the above photograph was made. In background is the Triborough Bridge; and in foreground, the East River.

Protesting Government concern over the Mae West-Charlie McCarthy-Adam and Eve program (allegedly naughty jokes). Eugene O'Neill's "Beyond the Horizon" broadcast (cuss words, 'tis said), and the Orson Welles "War of the Worlds" fantasy (interplanetary-war scare), the *New York Daily News* last month editorialized, under the title,

"The Threat of Radio Censorship," as follows: "If the Government gets control of radio programs, the totalitarian dictatorship so much dreaded by newspapers will be appreciably nearer."

Caddies who complain of poor business can take a lesson from an event at (Continued on page 497)



RADIO RANGE DEMONSTRATOR

Last month announcement was made of a device which an instructor can use to fully demonstrate the operation of the airplane aural radio range. Boeing School of Aeronautics (Oakland Airport, Calif.) flight instructor LeRoy B. Gregg is here shown explaining its operation. The apparatus consists of 2 units. One contains an A.C. power supply, audio oscillator, and a small motor driving 2 cams on a single shaft at a speed of 1.5 r.p.m. One cam has 12 raised "A" or dot-dash (· —) code signals and the station identification signal OA (Oakland); the other cam has 12 "N" or dash-dot (— ·) signals with the station signal OA. These code signals are heard, at a volume sufficient for a large group, through a loudspeaker in the second unit. This unit also contains a mixing panel and an A.F. amplifier. Headphone jacks are also provided on the amplifier control panel so that 4 students can listen with the instructor at one time. The instructor can talk to the 4 students through an interphone system without removing his headphones, said director T. Lee, Jr. Having learned to correctly interpret the signals the students later practice radio beam flying in a Link trainer.



8TH EUCHARISTIC CONGRESS

New Orleans, La., last month played host twice, simultaneously. Once to the 4-day session of the 8th National Eucharistic Congress (which N.B.C. and C.B.S. broadcast), and once to the largest and most powerful sound system RCA ever installed in the city. Four 100-watt loudspeakers were installed in the belfry of St. Patrick's Church; 2 to 3 pulpit microphones and 2 to 12 loudspeakers were installed in each of 15 other churches. Outdoor location utilized 8 other systems (including one at Union Station). A paging, announcing and record-playing system was installed in the Civic Auditorium. An RCA Mobile Broadcast Unit, P.A.-equipped, helped control traffic. Sound recordings were made. A table-model radio set was installed in the quarters of each of the 76 Archbishops and Bishops who attended the Congress. (Photo shows Gov. Richard W. Leche, of Louisiana, delivering welcoming address to George Cardinal Mundelein (right foreground), Archbishop of Chicago and personal representative of Pope Pius, on his arrival at Union Station.

UNIQUE SOUND EFFECTS

The professional Sound Effects Man came into existence about 10 years ago. Modern programs, as for instance the Wells-Welles "War of the Worlds" broadcast of a couple months ago, attest to the dramatic value of his trade today.

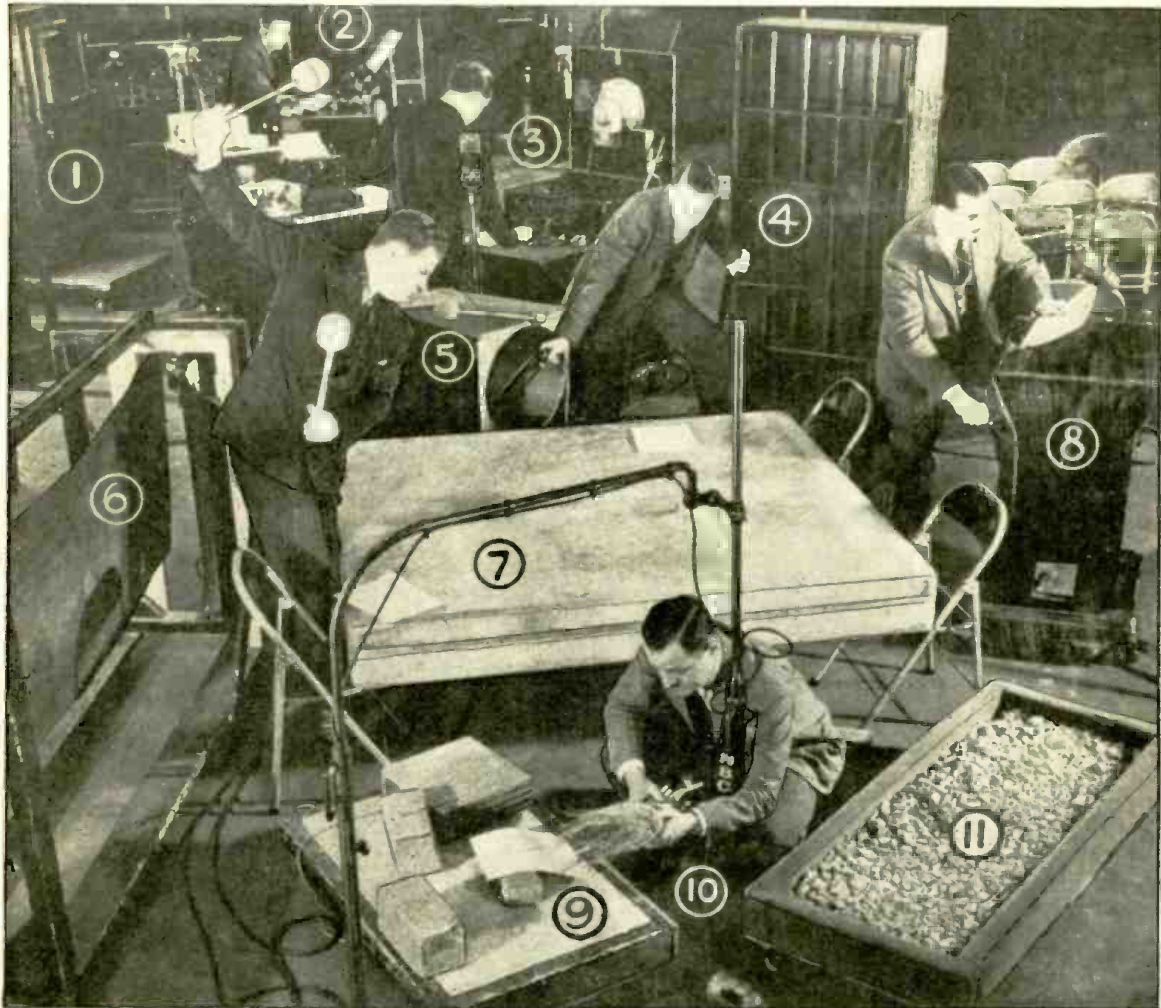

Some of the sound effects used at the National Broadcasting Company studios today are shown in the above scene at Radio City studios. (1) An automobile door, (2) turntable for playing recorded sound effects, (3) "wireless" (radio) code oscillator, (4) jail door, (5) echo chamber, (6) electric thunder sheet for high explosives and thunder, (7) thunder drum for small explosives, distant cannon, thunder, (8) splash box for water effects, (9) concrete walk for footsteps on pavement, (10) straw for sounds in underbrush, (11) gravel pit for walking in gravel.

NEANDERTHAL man may have been the first to employ sound effects—50,000 to 100,000 years ago—when, in order to distract the attention of game he was stalking, he threw a pebble to create the illusion of action at a remote point.

It was not until 10 years ago, however, that the Sound Effects Man really achieved professional status; in 1929 the National Broadcasting Company created a Sound Effects Department and put in charge the man who still heads this department as its Chief Technician—N. Ray Kelly.

Until then sound effects had been produced, when provided at all, by a snare drummer, the traditional sound effects man of the old theatre.

Despite the considerable degree of candor with which sound effects men

R. D. WASHBURNE

discuss their art, still, it reeks of "trade secrets"; and employs all the wizardry expert technicians are able to muster in order that such "scenery" will supply broadcast programs with the proper acoustical backdrop.

One of the most "exclusive" occupations in the world, less than 100 men are professionally employed in the trade, one network estimates.

Since the general activities of these men have been described at considerable length in newspapers and magazines, including *Radio-Craft*, it is for this reason that only the more unusual and newest sound effects they have developed are here described. Columbia Broadcasting System, National Broad-

casting Co., and the British Broadcasting Corp. have cooperated in making available to *Radio-Craft* readers the following descriptions of unique sound effects.

C.B.S.

In a laboratory on the 13th floor of the C.B.S. building, C.B.S. sound effects engineers have developed a big improvement on the old-fashioned hand telephone. Formerly, when a script called for telephone sound effects, the sound effects engineer had to ring a bell, then pick up a dummy phone set. Or if the actor in the script was to dial, the sound effects man had to dial on a phone set and make the sound of the ringing current or busy signal with separate buzzers.

Today, all this can be done on one



A horse and wagon lumbers along a rough mountain road—in the C.B.S. studios! A small wagon wheel is turned by Henry Gauthier, & Walter Pierson works 2 cocoanut shells in sand, for the horse.

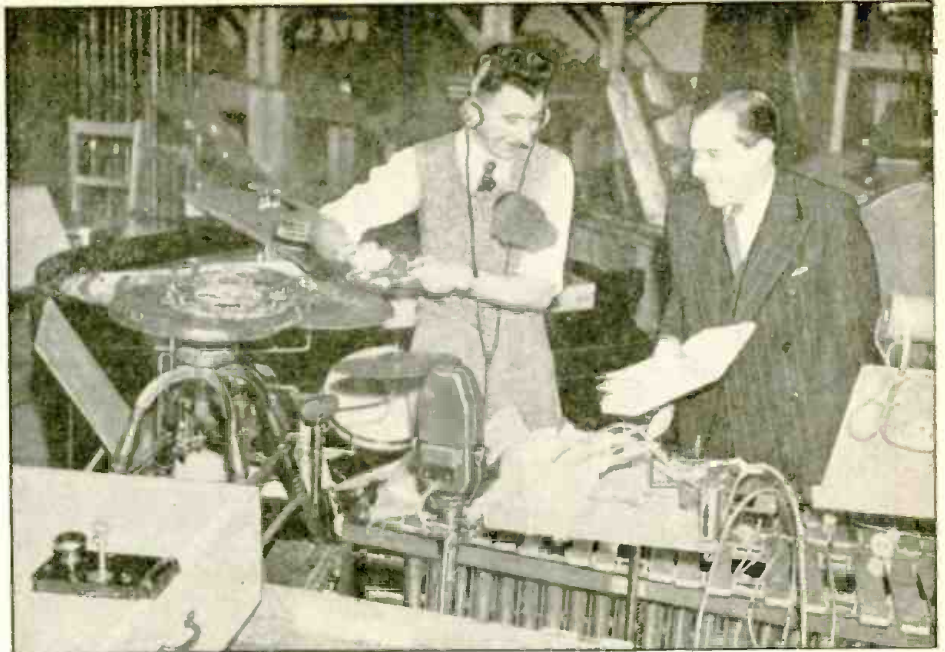

Styx Gibling (left), drummer of the B.B.C. Variety Orchestra, discusses with John Watt, Director of Variety, his efforts for the recent broadcast version of "Snow White and the 7 Dwarfs." As Gibling seldom had time to watch the conductor, he listened to his cues through headphones.

piece of equipment—a specially-built phone set attached to a neat little black box about 8 x 8 x 4 ins. Inside the box is a battery which controls the bell, the ringing current, and a "busy" signal. The C.B.S. Sound Effects Department has 20 such highly-condensed phones.

Also there are 5 specially-built switchboards. They were made from the parts of an actual switchboard, bought from the telephone company. There are 3 plugs to each switchboard, and flipping a little key gives you a triple choice of bass, baritone, or tenor buzz.

There's an anchor machine, too. It consists of 2 horizontal bars with a chain slung over them, turned by a hand crank. It will give you, on the air, the sound of a gang plank being lowered, or the lowering of an anchor. Walter Pierson, Sound Effects head, and his assistant Max Uhlig, shopped for one whole day in a chain factory, selecting the right chain to use on this machine. They went around the factory with hammers, tapping at all the chains to discover the one with the right resonance.

Even the old-fashioned thunder drum has been replaced by an electric one—a big square of stretched screen wire to which an ordinary phonograph pickup has been soldered. When the screen is struck with a padded drum-stick, the vibrations are picked up and fed through a speaker to the microphone. You can't even hear this thunder without the speaker.

Such exotic sound as the whir of meteors rushing through space are taken care of quite scientifically, too. In the Columbia Workshop production of "The Wedding of the Meteors" (a good script for experimental work in college radio guilds and such groups), for instance, they used a wind machine, pitched very high in frequency, along with music, and, as the meteors approached the earth, they "faded-in" a dynamo hum on records.

Another pretty imaginative effect was that of the voice of "Alice in Wonderland," another Columbia Workshop production, as she grew bigger and bigger
(Continued on page 492)

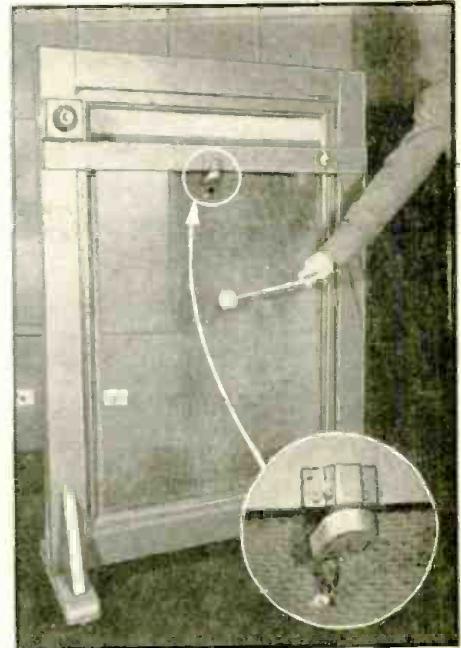

This is C.B.S.'s new electric thunder screen of copper gauze, with phono pickup on top crossbar. Top-right, studio loudspeaker lead; top-left, gain control.



N.B.C.'s "body of man falling to street" sound is accomplished with a squash (of squash, not man).



For a drowning act, C.B.S.'s Ray Kramer removed the "innerds," dunked his head, and bubbled.



For a "telephone voice," N.B.C. actor John MacBryde, pressed nose & talked through cupped hand.



▲ From this modern radio studio in the Interior building will come Federal Government reports to the Nation. A small speakers' studio can be seen through the glass of the control room in the background. The "more important" visitors to the studios, by talking into the microphone in foreground, may have their voices recorded in the "oral guest book."

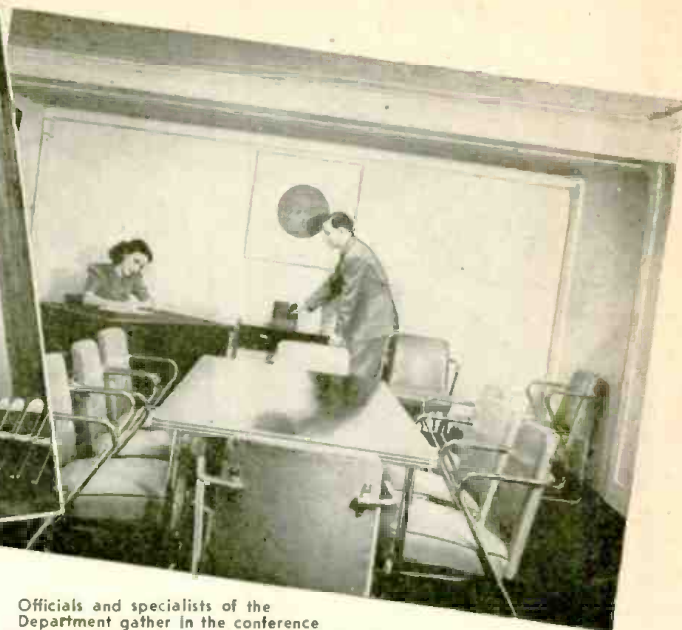

▲ Officials and specialists of the Department gather in the conference room to check the radio "program reports" of that Department, which emanate from the new broadcast studios recently put in operation in the Interior building.

UNCLE SAM'S RADIO STUDIOS

The United States Government does not have its own broadcast station but it does have its own studios. From these new \$100,000 studios the Department of the Interior sends special programs of its activities and plans by wire to broadcast stations throughout the land.



▲ The chief engineer for the Department's new broadcast studios inspects his control room equipment, capable of producing radio programs ready to be "fed" to any station or network in the land.

THE United States Department of the Interior, feeling an obligation to report to the public, the functions and services of its various Offices and Bureaus, has created facilities for the careful planning, preparation and production (up to the point of making the actual broadcast) of program-reports to the public by radio. Therefore, in July, 1938, a radio section of the Division of Information was created.

The Radio Section is housed in the top floor of the new Department of the Interior building, in the first radio studio ever built by a government

agency, with the idea of informing the people of the United States what their government is doing.

Here are offices, an audition room, reception room, artists' lounge, engineers' office, control room and 2 studios; a large studio for dramatic production and a smaller studio for speakers. The large studio is 41 x 24½ feet and has outlets for 6 microphones; this is studio A. The smaller studio is 22 x 13½ feet and has outlets for 3 microphones; this is studio B. The control room contains all equipment necessary to amplify, monitor, and dispatch programs originating in the studios. Both studios are of full floating construction and all rooms are air-conditioned.

The staff of the Radio Section consists of Shannon Allen, Acting Director; Bernard Schoenfeld, Chief Script-Writer; Lola Wyman Horton, in charge of Audience Preparation; and Hugh Russell Fraser, head of the research unit. A. R. Rumble and H. A. Robitaille are the engineers.

The task of preparing program-reports for the nation is a complicated process. The smallest detail of the workings of every agency and bureau within the Department of the Interior are tracked down by expert research specialists and included in the Research Li-

(Continued on page 497)

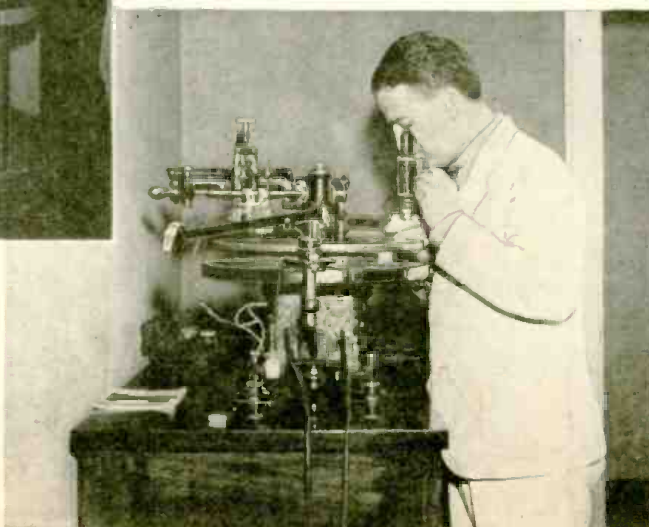

Electrical transcription of "program reports" on the work and services of the Department will be made on this recording machine, part of the equipment of the new broadcast studios.

RADIO HELPS FIGHT AIR-RAIDS!

"Air Raid Protection" is a subject of outstanding importance in England, and during the recent, unsettled situation many "A.R.P." measures were given a try-out. In this article, exclusive to RADIO-CRAFT, author Norton gives some idea of radio's part in the extensive plans; and how B.B.C.'s television programs have brought these measures home to London "telev viewers." Sir Samuel Hoare's radio broadcasts are scheduled to net enlistment of 1,000,000 air-raid wardens.

MICHAEL NORTON

Henley on Thames, England

FEW people over here in England realize how much radio has been used in connection with *air-raid precautions*. More astonishing still is the part it is going to play in the case of a real air-raid. It is now possible for radio fans to learn something of the wonderful service radio is to perform in rescuing mankind from the latest form of brutality.

Last March, Sir Samuel Hoare, the Home Secretary, gave a radio talk on air-raid precautions, which went out from all British stations. Of course millions of people heard this, but they are so used to radio talks in their homes, that they do not realize the enormous power of radio as a link between people and government. This does not mean that they no longer listen. Fortunately, England is not one of those European countries where you have to listen-in to show that you are a good patriot. People listened because they are interested in air-raid precautions.

We all want to know how we are to protect ourselves, our families and friends, if there is an air-raid. One does not have to be a patriot to want to do that. And so, by means of his radio appeal, Sir Samuel Hoare enlisted 400,000 air-raid wardens. Since a total of a million is required, he made another appeal 2 months later, and it is expected that by the time this article appears in print the required number will have been enlisted.

Television has also been used to help against air-raids. Viewers saw a diagram of 3 rooms of different kinds—a basement, a room with 2 outside walls, and an inside room. They witnessed the gas-proofing of these rooms and were shown the regulation dark blind being drawn down over the window to prevent light being seen by attacking airplanes.

In time of war, broadcasting would be used even more to advise the people, and the British Broadcasting Corporation would probably be taken over by the Government. This was done during the General Strike in 1926, when radio was one of the few sources of news, since most newspapers were unobtainable. We can judge only by what happened in the past, because the British Broadcasting Corporation will not disclose what is being done in case of war and in case of air-raids.

As a matter of fact, a friend of mine who works at Broadcasting House, told me that the staff were being asked to become air-raid wardens. He admitted he had done nothing. Having known him since we were at school together 15 years ago, I realize that this is only because he is rather lazy. He said that others had done something. As there are 3,500 members of the B.B.C. staff, they will be able to find enough air-raid wardens.

At Broadcasting House, they will not wear gas masks, but will remain in gas-proof rooms and tents. This is probably

because the studios have no windows and are air-conditioned by the plant in the basement. All this will be made gas proof; but, as yet, no radio station can be made entirely bomb-proof against a direct hit. Therefore, in case of emergency, our 4 transmitters not situated in towns, namely Droitwich in the Midlands, Burghead in Scotland, Start Point in Devonshire and Lisnagarvey in Ireland, could increase their power to 100 kilowatts and cover the whole of the British Isles. The Irish transmitter can already do this. Hence we shall have the radio while sitting in our cellars or in the trenches in our back gardens that the authorities recommend.

The popular idea that radio communication is not to be used in time of air-raids is based on the following statement in the *T. and R. Bulletin*, the journal of the Radio Society of Great Britain:

"We have been informed by the Home Office that the use of radio has not been contemplated in connection with A.R.P. Members joining the A.R.P. organizations should mention and ask for a note to be made that they are



A London "bobby" is here shown using Tannoy's new Power Microphone. This equipment is an effective aid in "A.R.P."



The London firm of Tannoy has made available to *Radio-Craft* this close-up, and the action view at upper-right of this page, of the Power Microphone. This compact public address unit, powered by a 12 V. storage battery, projects speech a distance of nearly 1/4-mile. The microphone is designed to prevent acoustic feedback ("howling"). No amplifier is used; instead, a sensitive microphone drawing several amperes (momentarily), coupled through a matching transformer to the loudspeaker, is used.

interested in radio, in case it should be decided at a later date to include it into the scheme."

So many of us know of the wonderful work done by the United States amateurs at the time of the Ohio floods, that many suppose that British amateurs might do similar work in a national crisis over here. But the British amateur is not quite in the same position as the amateur in the United States. He does not enjoy the same privileges. He cannot handle third-party messages, and moreover, his equipment is less powerful and is inclined to be an inexpensive home-constructed rig.

Despite this announcement, those very experienced British amateurs, who are expert radio engineers, will be asked to cooperate in time of war and in time of air-raids. There was an excellent example of this co-operation during the recent blackout at Slough in Buckinghamshire, an area including Windsor Castle. In this rehearsal, radio, under the direction of an amateur, was used with great success. There were 3 main control points, one of which was the local town hall. These stations took about 27 minutes to install, complete with antennas, and they were in operation within half an hour. They could make contact with each other in less than 5 seconds, whereas telephone communication would have taken 75 seconds.

The 20, 40, 80 and 160 meter bands were used. The receivers were ordinary commercial.

(Continued on page 498)



The RADIO-CRAFT plan for a Radio Home with reception in every room, opens up for the industry a vast new market which will benefit the consumer, the radio dealer, jobber and manufacturer, and the radio Serviceman.

PART II

N. H. LESSEM

LAST month we announced our unique plan for stimulating business in the radio industry—a plan which gives the public radio in every room and the radio manufacturers an immense new outlet for the sale of their sets, speakers, switches and other products.

We went into all the details of the plan, pointing out how everyone concerned would benefit;—how the entire system could be built-in at the time of construction; how the home owner could have his much desired radio-in-every-room with perfect remote control of the master radio; how the builder could use such a radio system as a powerful talking point for stimulating the sale of homes; how the radio manufacturers would thus have a vast new market opened for their receivers, remote speakers, pushbutton tuning switches, volume controls, wiring cables, etc.; how manufacturers of such allied products as mercury-contact light switches and electrical “TELECHIME” paging systems could profitably tie-in; and finally how the radio servicing industry would have an entirely new and lucrative maintenance field thrown into its lap.

Carrying the résumé just a bit further, we announced the construction of the so-called “Average American Family

Home” for the express purpose of building-in such a radio installation. The house is now under construction and at a point which is most propitious for the preliminary work of installation. Provisions for locating and installing the remote speakers must be made now, before the application of the lath makes it inconvenient to run the necessary cables through the wall partitions. In Part II therefore we will discuss the preliminary wiring, suitable locations for the various speaker units, the acoustic problems involved and the method for mounting the remote speakers and other units for convenient servicing. It is well to bear in mind that since few homes are ever built alike, these plans will necessarily vary with individual cases. However the fundamentals remain the same. Therefore our description will pertain to our “Average American Family Home.”



PLACEMENT OF LOUDSPEAKERS

The locations of these various speakers were shown in the diagram of the floor plan in Part I. They are also shown in Fig. 3 and on the cover of this issue. There are 2 in the large living room (1 on each side of the fireplace under the built-in book niches); 1 in the master bedroom conveniently located between the 2 twin beds; 1 in the small bedroom; 1 in the bathroom; 1 in the kitchen; and 1 in the

dinette. Individual preferences of course will vary.

For best acoustical effects these speakers should be placed at about ear level, which is at an average height of 5½ ft. from the floor. At this height the tuning buttons will also be within easy reach of even short persons. The 2 speakers in the living room however must be installed closer to the floor inasmuch as the book niches are quite low. This is true of the speaker in the master bedroom; although here it does

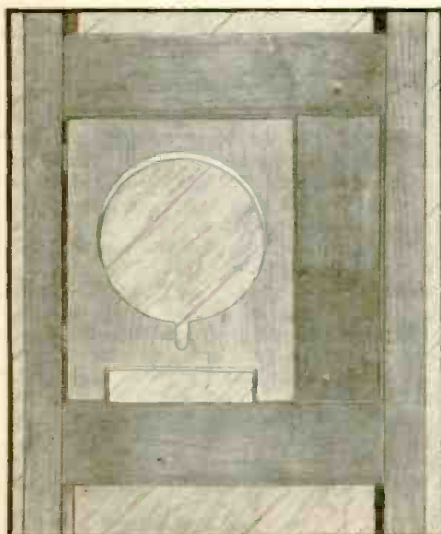

Fig. A. Before the lath and plaster are applied to the walls, the speaker brackets are mounted in place on hinges and squared off with 2" x 4" studs.

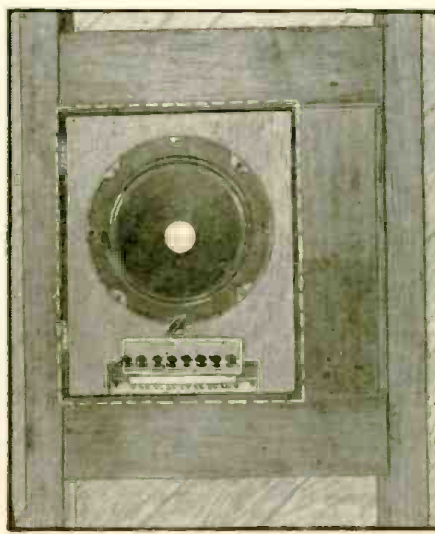

Fig. B. Here the remote speaker, pushbutton switch and T-pad are shown mounted on the bracket. The dotted white line indicates where plaster will end.

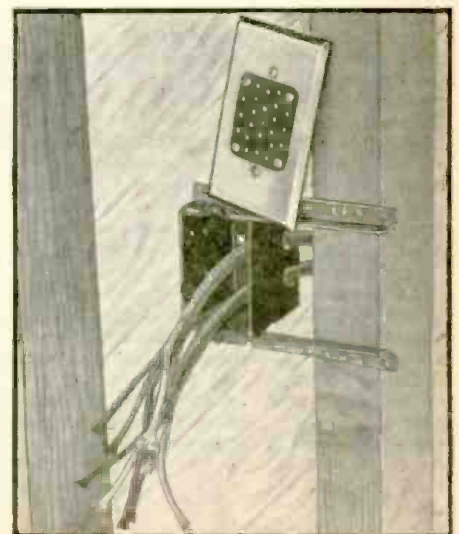

Fig. D. The 22-contact armchair-control outlet mounts in a standard Gem box. Not all of the 22 contacts are utilized for the radio system.

not matter so much for when reclining in bed the loudspeaker is still at ear level.

Wherever the speakers are mounted high in the wall the tuning buttons should be below the speaker; wherever they are mounted low, the tuning buttons should be above the speaker. These are all indicated in the above mentioned diagram (in Part I) of the floor plan as well as on the cover of this issue.

These locations of course may vary depending upon the amount and type of furniture you may have. The speakers should be placed where they will have a free and clear range and where they will not conflict with present or future furniture.

Another consideration is convenience in tuning. It should not be necessary to have to lean over a table to press the tuning buttons or to have to stand on a chair.

MOUNTING THE REMOTE LOUDSPEAKERS

Since this installation is a permanent one, built right into the walls of the house, the problems of future servicing should be taken into consideration. Here, accessibility should be the keynote. For this reason it was decided to mount all remote units, viz., speaker, pushbutton switch, T-pad and pilot light, on one wood bracket as shown in Figs. A, B and C. Specifications for making these supports are given in Fig. 1.

As shown in Fig. A, the speaker bracket is mounted at the desired location between 2 of the numerous vertical 2" x 4" studs which go to make up the wall partitions and is so hinged as to swing out for convenient wiring and future servicing. Figure C shows the point very clearly, showing in addition a rear view of the mounted apparatus. Figure B illustrates the front of the apparatus. Of course, when the system is completely installed, a decorative grille will cover everything. The white dotted rectangle illustrates where the

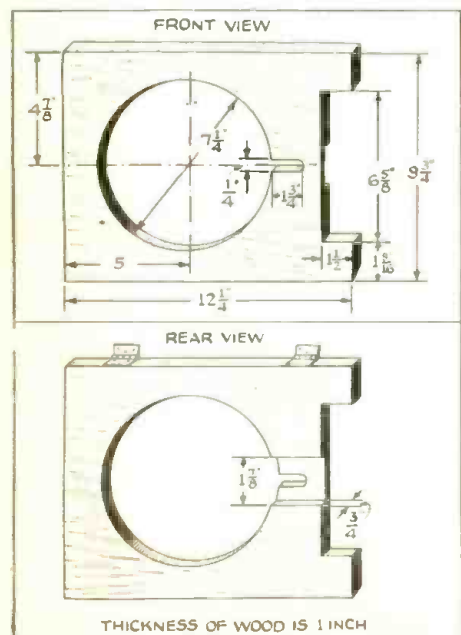

Fig. 1. Complete specifications for making the speaker brackets. The wood may be soft stock for speaker and switch lend strength to it.

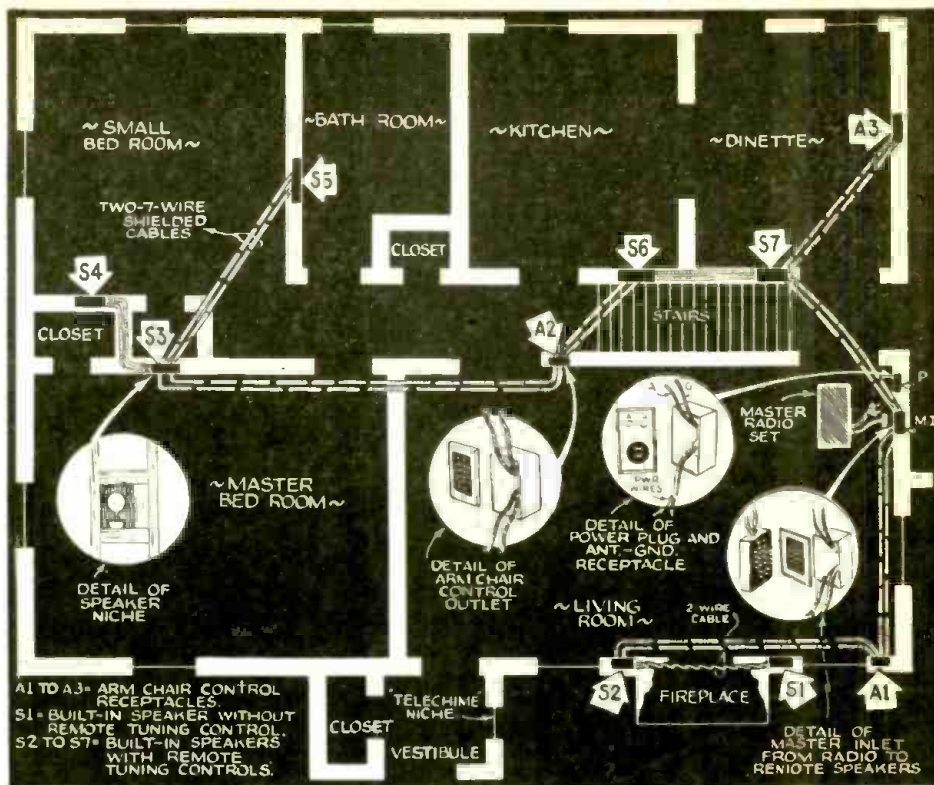

Fig. 3. Preliminary wiring diagram showing how to run the cables to the various remote speaker niches and armchair-control receptacles. The dotted lines represent cables passing under the floor, otherwise they pass through the walls.

wall plaster will terminate, thus permitting the entire bracket to swing out freely on its hinges without obstruction.

AIR COLUMN FOR BACK WAVE

In building the speaker into the wall there is one important difficulty which must be overcome—*cavity resonance*.

It is a well-known fact that if we mount a speaker in a box the back of which is closed in we get a tone which is low and boomy as though it were issuing from an empty barrel. This is due to the back pressure of the speaker diaphragm causing the air inside the box to resonate at certain frequencies.

This frequency discrimination distorts the program to an annoying extent.

In building our speakers into the walls we have a similar condition. To overcome it we must do 2 things. (1) We must provide a long column of air so that the back wave pressure will not be too great and (2) we must absorb as much as possible the sound caused by this back wave.

In Fig. 2 we show how the long air column is obtained. We merely take advantage of the existing airspace between the vertical 2" x 4" studs, being careful not to obstruct it in any way.

(Continued on page 490)

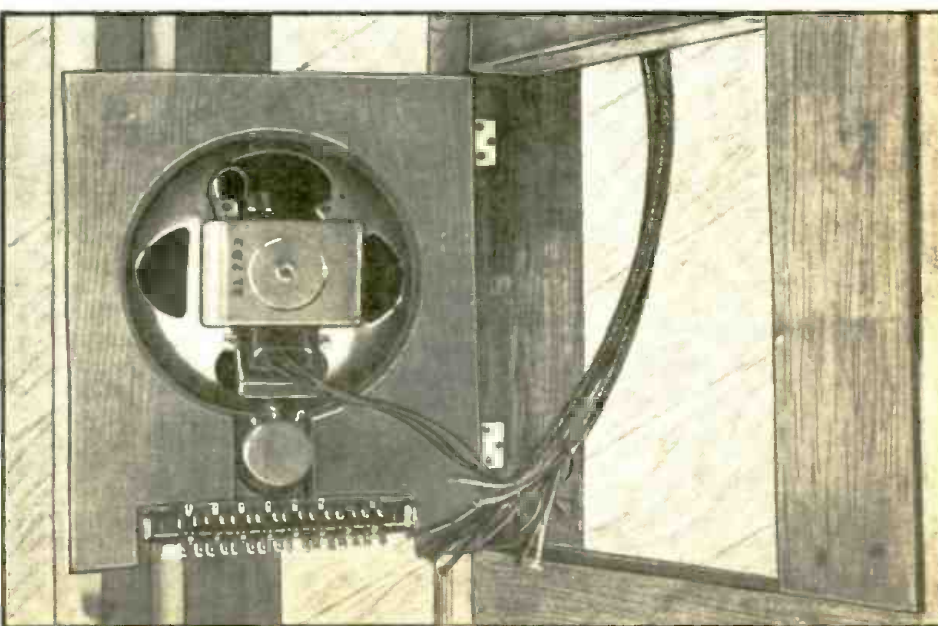

Fig. C. Ease and accessibility of servicing is the obvious keyword of this installation. Speaker, pushbutton switch and T-pad (the pilot light has not been mounted as yet) all mount on a single wooden bracket which swings on 2 hinges. When closed, the bracket is flush with the studs.

BROADCASTING—

As I Imagined It...

Lee de Forest

On his 65th birthday, the inventor of the vacuum tube which made modern radio possible, looks back down the years and comments: "I seldom tune in . . . The programs, all swing and croon, are not only poor, but the interruptions for commercial announcements are maddening . . . Isn't it sickening? It isn't at all as I imagined it would be." (Quotation is from Time magazine.)

IN season and out, from the early days of commercial broadcasting, I have seldom missed an opportunity to criticize the quality of the average radio program and to inveigh against the crudities, lack of showmanship, and plain bad manners of the majority of the commercial advertisers or their program directors.

In 1930, when I was President of the Institute of Radio Engineers, my Inaugural and Farewell Addresses were devoted in large part to this aspect of radio which, on account of its extreme public interest, has received unfortunately all too little attention from the radio engineering profession. Like most engineers, we assume that if we perform our technical duties to the best of our ability we have fully discharged our public and civic obligations, a narrow minded and selfish attitude which is not particularly creditable to the noble profession of Engineering.

In some of my early interviews or

articles on the subject of radio programs I outlined what appeared to me a happy solution, while fully realizing that in the United States there is at present no possibility of introducing such a reformation.

**This article is
special to
RADIO-CRAFT**

Briefly the idea is as follows: In every metropolitan district a certain station should be devoted to a definite type of program. For example, one to a higher class of music—symphonic and opera; another station to more popular types of music, with certain definite hours devoted to dance programs; another station to drama, serials and the like; one station devoted wholly to crime suppression stories, bedtime thrillers, and miscellaneous hysteria; another to educational themes of popular interest and adapted to popular presentation. This latter station could appropriately be the news outlet for the district, with news bulletins every two hours or so. This station might appropriately be devoted to political harangue, during the open season for candidates. Another station (and this would undoubtedly be the most popular of all) devoted wholly to crooners, jazzers, swingers, and jitter bugs. And finally, one station devoted wholly, 100 per cent, to undisguised, unadulterated advertisements! I do not believe that very short sponsoring announcements introduced every half- or quarter-hour into any of these programs would be seriously objectionable provided these under no conditions ex-

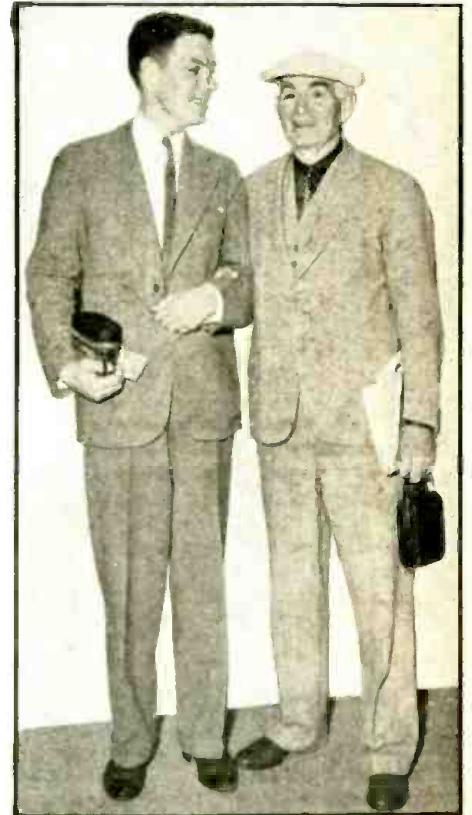

Dr. Lee de Forest (right), inventor of the vacuum tube, as he is today. He is shown with Mr. McMurdy Silver in Chicago (attending the Braddock-Louis fight) where the degree of Doctor of Engineering was conferred upon him by the Lewis Institute. Mr. de Forest is 3 times a "Doctor," holding the degrees of Ph.D. and D.Sc., previously. He was born in Council Bluffs, Iowa, August 26, 1873.

ceeded 30 or 45 seconds in length.

Picture what a relief to the radio listener's nerves such an arrangement as I have above outlined would afford. If any listener wished to hear a certain class of entertainment at practically any time he would know exactly where to dial to obtain it, and he would be certain of obtaining that kind of entertainment from that station so long as he cared to listen. He would not, as at present, having after considerable patience found a pleasing program, seat himself to enjoy same only to have to get up at the end of 15 minutes at most to twirl his dial to find relief from the altogether different material to which the original station had unceremoniously switched. After one does this several times and is more or less maddened by the blatant commercial plugs which he is forced to listen to, he turns off the "relief" switch in disgust, and that is the end of his radio for the evening. Undoubtedly he thereby misses a lot of good entertainment which he would have been delighted to hear had he been freed from the infernal necessity of

(Continued on page 496)

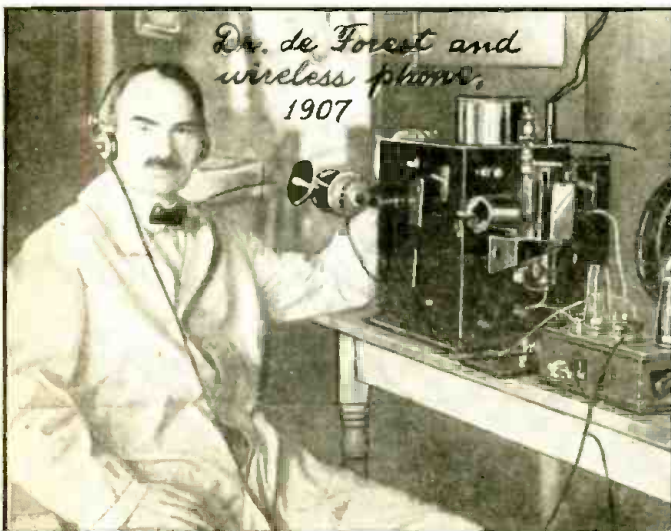

Dr. Lee de Forest as he appeared in 1907 with his first wireless (radio) telephone. Broadcasting—as America knows it today—may be said to have had its birth early in that year when Mr. de Forest constructed the first means of modulating an arc transmitter with voice impulses and began sound broadcasting from atop the 12-story Terminal Building in N. Y. C.

Newest-Type WIRELESS PHONOGRAPH ... with Microphone

The radio industry has at last caught up with RADIO-CRAFT, —several manufacturers are offering a useful device employing principles first disclosed in RADIO-CRAFT several years ago.

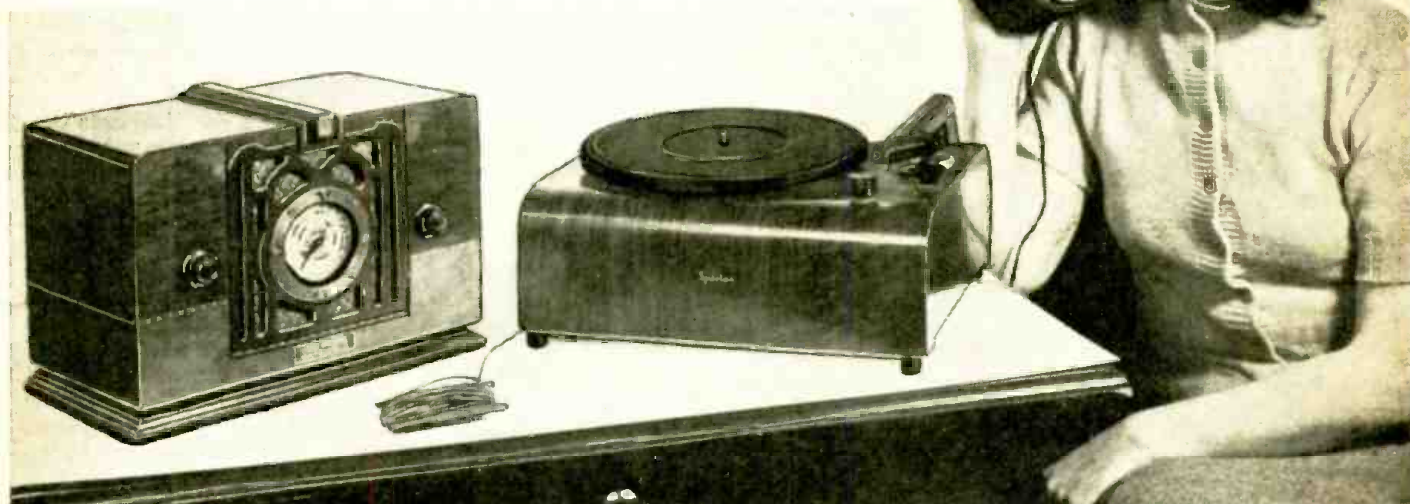

Fig. A. The winsome lass pictured above is using only the microphone connected to a Wireless Phonograph to stage a little "radio broadcast" all her own. The phonograph portion however, may be used simultaneously or independently, as preferred. The wireless phonograph is here shown in close relation to a standard, midget-type radio receiver; it may be connected directly to it or located in another room, as conditions dictate.

LAST month a well-known radio set manufacturer introduced a "Wireless Phonograph and Microphone" which makes every home radio set a sort of self-broadcast station. That is, the program originates in the home and is received in the home.

The "sending station" in this case is the little box shown (center) in use in the heading illustration. As this view shows (note "spooled up" antenna wire, in foreground), it is not even necessary to make direct wire connection between the "sending station" and the regular radio receiver (left) provided the distance between the two is only a few feet—possibly up to 50 or 60 ft., if the radio receiver is operated at maximum sensitivity and the "antenna" of the little 2-tube (and ballast "tube") sending station is strung out for the few feet of its length. The diagram of this A.C.

operated device is reproduced, with values, in Fig. 1.

This instrument has numerous uses—many of them profitable to Servicemen—as the little "thumbnail" illustrations at the end of this article show.

EARLY DESIGNS

At this point many readers of *Radio-Craft* may recall that this magazine presented what is believed to have been the first published article on a device of this sort in which the phonograph operation was stressed. (See "How to Make a Novel Portable A.C.-D.C. R.F. Phonograph Attachment," by R. D. Washburne and N. H. Lessem, April 1934.) We quote as follows from the April, 1934 issue of *Radio-Craft*: "... connect a phonograph pickup or a . . . microphone . . .

(Continued on page 500)

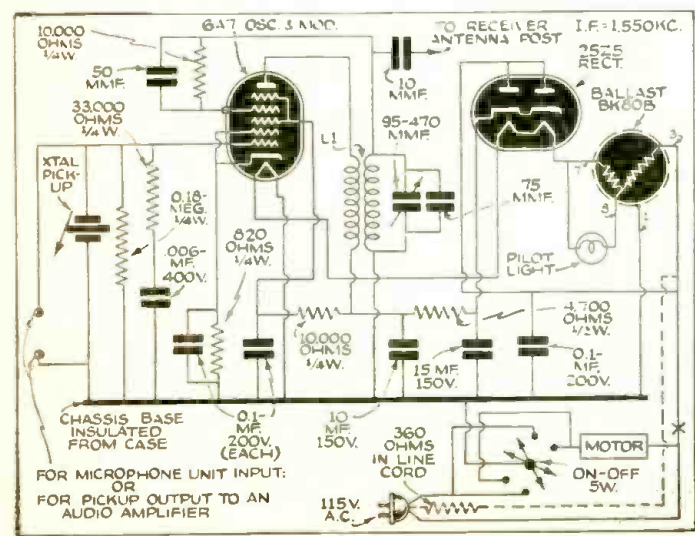

Fig. 1. This diagram shows the unit's efficient circuit arrangements made possible by recent improvements in tube design. A "ballast tube" takes care of the comparatively wide variations in line voltage found in various sections of the country.

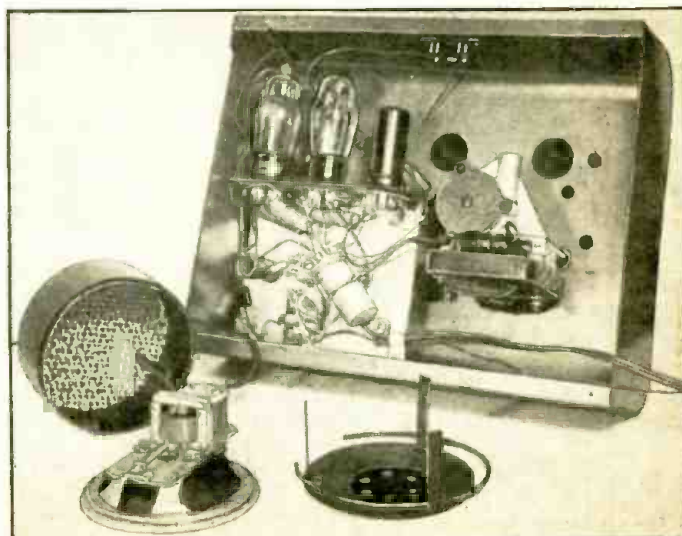

Fig. 8. Servicemen are here given a squint at the apparatus which, like any other good piece of radio equipment, they will in time be called upon to service. Meanwhile it is a swell sideline item—and easily demonstrated.

BUILD THE "LUNCHBOX 5"

A perennial favorite in radio apparatus is the portable receiver. To it, new attainable. The experimental model of the super-sensitive and -compact at \$100! Servicemen can "clean up" by demonstrating what this little set



Fig. A. This humble-appearing "lunchbox" is a radio set—complete with self-contained power supply and extensible antenna—ready to operate, at a moment's notice, and at loudspeaker volume.



Fig. B. The "innards" of the Lunchbox Portable. One No. 6 drycell will run the set for months. Note the P.-M. dynamic speaker above the cell; and note the telescoping fishpole-type antenna which plugs into the front panel and extends to 45 ins.

THE writer was planning a fishing trip into Canada where supplies had to be packed on foot and by canoe which created the need and the inspiration for a very small, lightweight, efficient portable battery radio set, sensitive enough to give good reception in that isolated section. About the same time leading tube manufacturers announced the 1.4 V. filament tubes which made this Lunchbox Portable possible.

LUNCHBOX

Much thought was given to obtaining a practical case that would be as small and light of weight as possible yet strong enough to stand the abuse given a portable. The ordinary lunchbox was finally decided upon and one was purchased at the retail store of a leading mail order house.

The inside dimensions of the lower unit were 9-13/14 x 4-19/32 x 3-28/32 ins. deep. The oval cover was a perfect design for a standard No. 6 drycell replacing the space occupied by the thermos bottle with room at one end to spare for the 3½-in. permanent-magnet speaker. A size of "B" batteries was found that fit the exact width and height of the lower unit. The problem then was to completely encase a 5-tube superheterodyne including 1 radio-frequency stage, its own antenna, and speaker, so that with the box closed it would be practically weatherproof, with the appearance of just a lunchbox.

LAYOUT

The parts layout was carefully planned to give a commercial appearance with precaution to have all aligned circuits dependent only on the chassis and partition for support and not on the lightweight case.

Size .030 sheet steel was selected for the chassis and formed into speaker panel, receiver panel, partition and sub-chassis as per photos and drawing. All chassis-to-case mounting holes in the chassis and partition were tapped for 6/36 machine screws, and countersunk to allow the screw heads to draw the lightweight case into the countersink and to present a flat, finished appearance.

It was necessary to mount the tubes horizontally as shown in Fig. B. Bakelite sockets that press-fit into holes cut into the sub-chassis were used as space did not permit use of sockets requiring mounting rivets or bolts. These tubes do not require external shielding if the layout is correctly planned. Referring to Fig. B, the layout starting at the upper-left-hand corner and proceeding in a clockwise direction is as follows: 2nd-detector and 1st audio tube, 2nd I.F. transformer, I.F. tube, R.F. tube, oscillator coil, converter-oscillator tube, output tube and in the center the 1st I.F. transformer. The output transformer can't be seen, but it is behind the 2nd-detector tube.

CIRCUIT

The superheterodyne circuit as per Fig. 1 is quite conventional and regeneration is not used. The antenna coil, L1, is

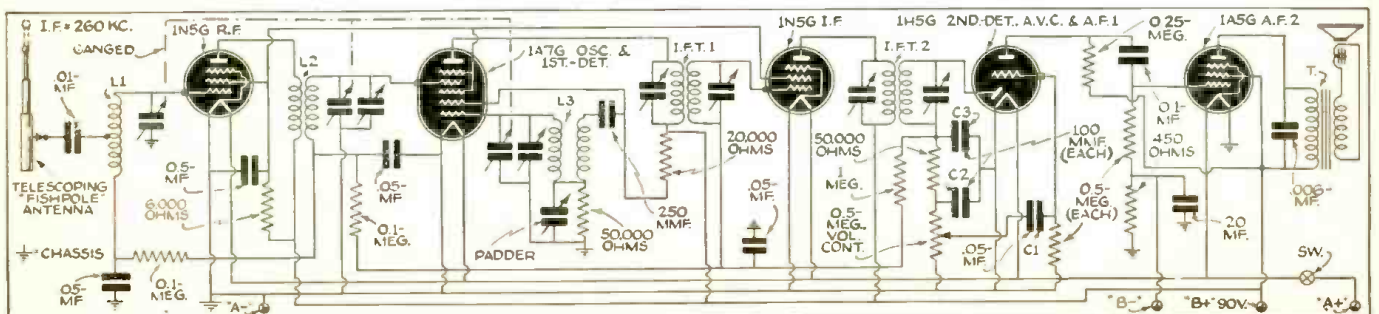

Fig. 1. Schematic diagram of the battery portable. The development of the 1.4-V. low-current tubes makes portable battery sets economical to operate.

BATTERY PORTABLE

1.4-V. tubes now add a degree of sensitivity and compactness never before portable "super." described in the following article is valued by the author can do; the custom trade will "go" for a set of this sort built to their order.

exactly matched to the telescopic antenna when it is extended to 45 ins.; the addition of a longer aerial or ground is a detriment and unnecessary. This coil is of iron-core, high-gain type. The R.F. coil is capacity- as well as inductance-coupled to increase that stage's gain at the 600 kc. end and thus compensate for loss at that end in the antenna coil caused by the small amount of coupling offered by the telescopic antenna (which measures 27 mmf. capacity).

The grids of all the tubes except the output tube are returned to ground. The self-bias is desirable on the output tube as it removes only 4½ V. from the "B" supply to that tube and the bias remains of right proportion as the "B" batteries run down.

Automatic volume control is used to compensate for fading of signals. The sensitivity measured with a General Radio output meter and a signal generator was 3 microvolts at the 1,500 kc. end, with a linear drop to 10 microvolts at 600 kc. This was at 50 milliwatts which is ½ the rated output of the 1A5G tube; with distortion, about 150 milliwatts can be obtained. The total "B" current drain was very low, measuring 3¾ ma.; the "A" drain was only 250 ma. The estimated life of the batteries using the radio set 3 hrs. per day is approximately 2 months (that is, using a "double life" drycell).

The center section of the 3-gang condenser should be used as the oscillator tuner separating the R.F. and the antenna sections and thus prevent regeneration of the high-gain circuits. The R.F. section is the one nearest the shaft end. The trimmer should be removed from the antenna section with sidecutters (pliers), or by employing a similar method.

The gang condenser may be mounted without rubber washers as, due to the speaker being mounted in the top away from the tubes and gang, no microphonic howl was encountered.

COILS

The antenna, L1, coil is wound on a good grade of iron core, and with 15/44 litz wire. Use the universal type of winding in a 7/32-in. pie. The grid end should be the start or inside of the winding and a tap brought out between 60 and 65 microhenries from the grid end. The overall inductance should match a condenser gang having a capacity of approximately 350 mmf. per section. The inductance value given above is the effective value with the coil in the shield can.

The radio frequency coil, L2, should be of high-gain (auto-radio) type and

G. E. ARCHENBRONN

the beginner might find it much better to purchase one, from some auto-radio service department or supply house, which is matched for a T.R.F. gang of 350 mmf. rather than try to construct one. It should be designed for a shield can of 1¾ ins. outside diameter, or less. Capacity coupling should be added if it doesn't have it. For this, wind 5 or 6 turns of No. 40 S.S.E. over the secondary, using a suitable insulating material between (such as cellophane), and connect one end of this coil to the plate end of the primary winding (leaving the other end free).

The oscillator coil, L3, of No. 32 wire, is wound on a ¾-in. form, with the secondary inductance matched to a 350 mmf., T.R.F. gang. The primary consists of about 15 turns, wound over the grid end. Insulate with cellophane, and mount in a shield can of not more than 1¾ ins. outside diameter.

The intermediate-frequency transformers, I.F.T.1 and I.F.T.2, should be designed for 260 kc. and should be of high-gain type. They must have their trimmers mounted in the top of the can (of not more than 1¼ ins. outside diameter). They do not have to be of iron-core type.

CHASSIS

For the speaker panel, cut from the sheet steel a piece 4-3/16 x 10-1/16 ins. For the center of the speaker hole measure 2-5/32 ins. from the top edge and cut a 3-1/16 in. diameter hole. The speaker mounting holes can be drilled by using the speaker as a template. About 6 ins. from the top edge cut a "back-wave" speaker vent ½-in. wide and extending within ¾-in. of both sides. Drill holes ¼-in. in from the side to accommodate the speaker and "A" battery wires, as per the photos. Solder 6 angle brackets, tapped for 6/32 threads, into the box cover in each corner and in the middle, and drill the panel to match. Cover the vent with grille cloth and place a wire mesh under the cloth for the speaker front.

The receiver panel is cut from sheet steel to 10-5/16 x 5-3/32 ins. This will allow a ¼-in. turn-down on 4 sides, leaving a top panel 9-13/16 x 4-19/32 ins. At a point 4-25/32 ins. from the top edge and 1½ ins. from both sides (see photo) drill two ⅜-in. holes for the condenser shaft and the volume control. At a point 5-15/16 ins. from the top edge and ¼-in. in from both sides drill 2 holes to mount partition. Add holes for binding posts to match lead holes in speaker panel.

The partition is cut to 4-27/32 x 4-11/32 ins., and turned down ¼-in. on

(Continued on page 505)

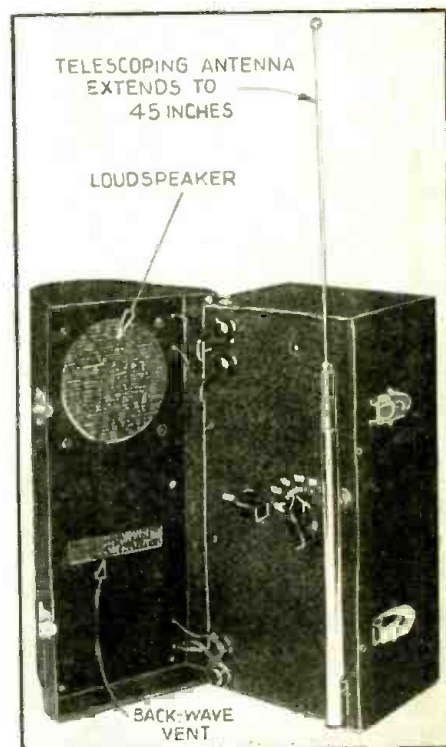

Fig. C. The selectivity of this little receiver is surprising. We were able to receive numerous stations in the editorial offices of *Radio-Craft*, located in a modern steel building in New York City, without interference. The "A" battery is located with the speaker where the thermos bottle is usually contained—in the cover.

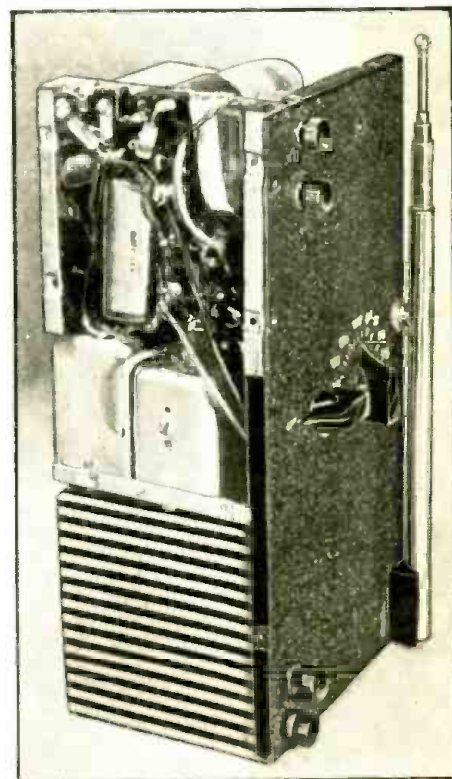

Fig. D. This under-chassis view of the portable gives you an idea of its compactness. The front panel controls are simple: one for tuning, and one for volume and on-off.

PLAY TALKIES THROUGH

Sound adds just as much to Home Movies as Television adds to radio; and in this concluding expense and less work. You merely place the new "wireless" home-movie unit near your

JACK ROBINS

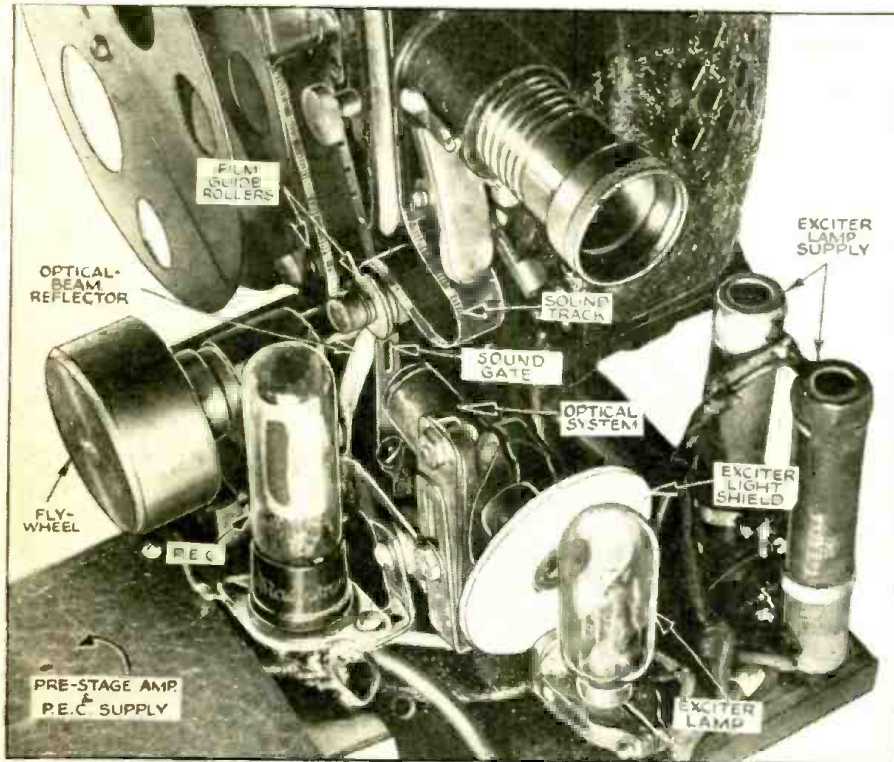

Fig. D
Close-up of the experimental model of the "wireless" home-talkie system.

were thoroughly discussed in the preceding installment. This, Part II, installment will therefore concern itself with the photoelectric cell and optical systems, and an explanation of how they work.

THEORY

Perhaps a short discussion of the fundamental principles involved will help get us started. In recording sound on film, the electrical variations in the microphone circuit, after being amplified, are caused to control a *light source* (an arc lamp, for instance) which in turn exposes a narrow track on the film. Thus for instance a shout in the microphone would cause a comparatively heavy current impulse in the microphone circuit and therefore a larger amount of light (due, for example, to the motion of parallel ribbons of a galvanometer-type *light valve* interposed between the light source and the *sensitized* or light-sensitive film) from the lamp and a more intense exposure on the film. The net result is a sound track, consisting of various degrees of exposure, evidenced as light and dark lines.

In translating this sound track back into sound, it is necessary to transform these light and dark lines into electrical impulses of corresponding strengths.

This is done by the optical and photoelectric cell systems mentioned above. Figure 3 shows in great detail just how this system performs. The light from the exciter lamp is first narrowed to a very fine ribbon by means of the *slit aperture* and then concentrated (focused) upon the sound track of the film. In back of this sound track is a highly-polished, reflecting surface. The amount of light falling upon this mirrored surface at any given instant will depend upon the amount of exposure which the sound track at that same instant had in the recording process.

In the December (1938) issue we described a unique but practical method which makes it possible for silent projectors to run off talkie films—through any radio receiver. (In many instances the projector will work by "wireless"—that is, *without direct connection to the radio set!*—Editor)

PRACTICE

Briefly, the description of how this is accomplished is as follows: A specially-constructed optical and P.E. cell (or "PEC") system, for translating the light variations on the sound track into corresponding electrical impulses, is added to the projector. These weak impulses are then amplified by a so-called *preamplifier* and then sent to another unit known as an *oscillator*.

This oscillator essentially is a miniature broadcast transmitter which sends out a radio signal modulated by the electrical impulses of the *sound track*. Therefore, any broadcast radio set coupled (connected, directly or indirectly) to the output of the

oscillator is able to amplify this signal and reproduce the original sound recorded on the sound track.

The remarkable part of this system is that not only does an inexpensive broadcast receiver replace the expensive amplifying equipment usually required to handle talkies but that fidelity of reproduction is comparable with if not better than this A.F. equipment.

Both the oscillator and preamplifier

For More Information . . .

. . . on this topic, refer to the following articles in RADIO-CRAFT:

HOW TO CONDUCT A SOUND-ON-FILM RECORDING STUDIO (In 3 installments)

All about making your own "talkies" at home; the principles of the several methods of recording; essential technique. (Servicemen can start their own Recording Studio.)

By I. Queen. . . . Started, November, 1937

HOW TO MAKE HOME TALKIES (Serial, starting next month)

An easily understandable, more elementary discussion of the equipment needed and the technique essential for making good home "talkies". It's easy to add "sound" to your old "silent" film; or to make your future "shots" as talkies! Such things as sound effects, angle shots, proper lighting, acoustics, scenery, etc., are amply covered.

By C. A. Tuffill. . . . Starting, March, 1939

YOUR RADIO RECEIVER

article, a motion picture engineer tells you how to get sound on your projector with little radio set's antenna post, to get sound! Patent has been applied-for on this system.

PART II

Thus if the exposure had been intense the line will be extremely black and very little light would fall upon the reflector and consequently upon the photoelectric cell. For a slightly exposed portion of the sound track more light will pass and more will fall upon the photoelectric cell, which thus generates a proportionately heavier current impulse.

We therefore obtain in the photoelectric cell circuit, current variations which exactly correspond with those in the microphone circuit in the recording process. These current variations are of course subsequently translated into sound by the loudspeaker of the radio receiver.

The variations on the sound track are sometimes extremely fine lines. Therefore in order that such fine lines be capable of blocking off a light beam passing through it, the beam must be no broader than these lines.

Stated more simply, the beam of light projected upon the sound track from the optical system must be no broader than the finest recorded line on the sound track. Further, this beam of light which is more in the shape of a very thin ribbon, must be no wider than the sound track. It is the function of the lens system to fashion this ribbon of light out of that received from the light source. The slit aperture between the 2 lenses, for this particular system, must have the dimensions of 0.71 x 0.00115-in. (exact).

IMPORTANCE OF CONSTANT SPEED

We all know that motion picture film must pass through the *film gate* of the projector in jerks or intermittently. This is done at the rate of 24 frames per second, thus giving the illusion of motion. However when this film passes through the optical system for translation into sound, it must do so at a constant speed or else distortion will result. To obtain this constant speed a fly-wheel system is worked out as shown in Fig. 3. It is important that this wheel run absolutely true in order to prevent "flutter."

This fly-wheel is in no way geared with any of the sprocket wheels of the projector. It depends entirely upon the friction of the film against its film drum for motion.

Add this "wireless" system to your *silent* or *talkie* unit.

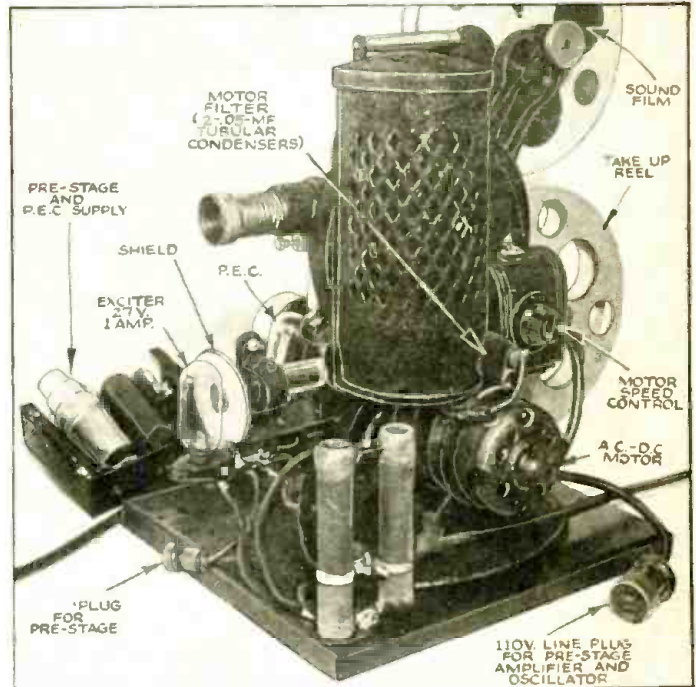

Fig. E

View of the exciter lamp supply resistors and the motor-static filter.

There must be a difference of 23 frames between the picture that is projected and the sound that accompanies the respective picture (note position of "film drum" in Fig. 3). It is *essential* that the photoelectric cell be *completely* shielded to secure quiet operation. Your local photographic supply dealer will be glad to help you secure any of the thousands of entertainment, industrial and educational talkie films, suitable for home projection, now available from a number of film libraries.

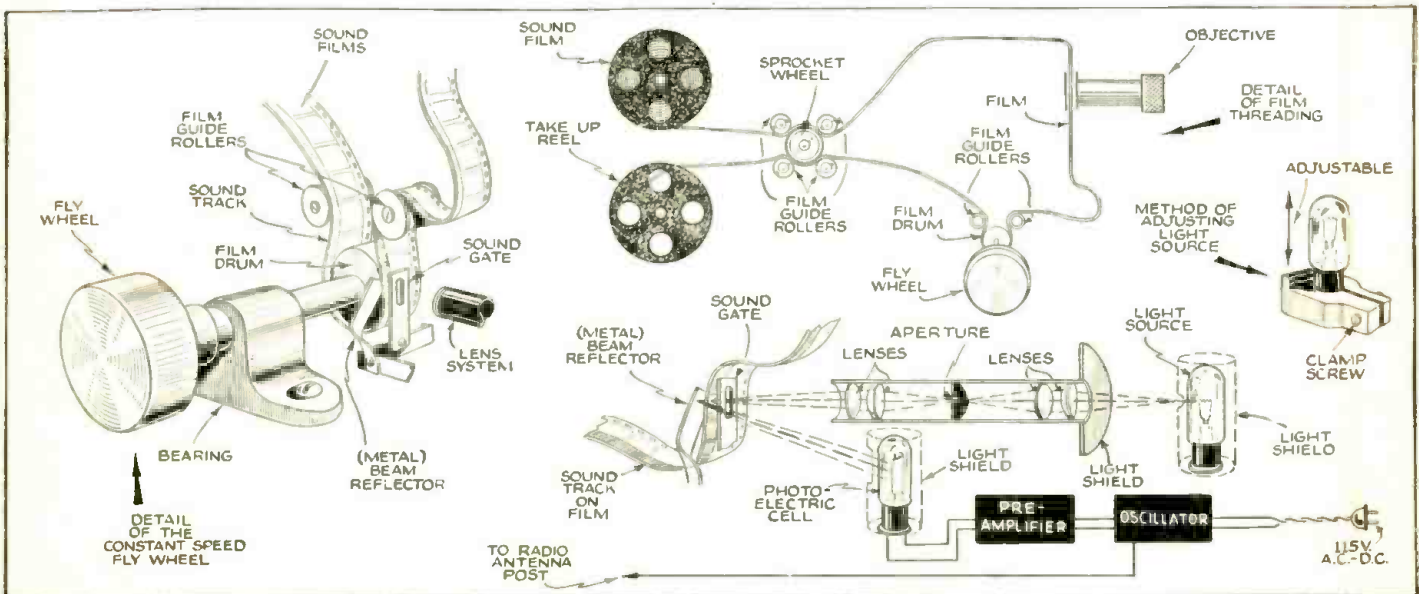

Fig. 3

The intense beam from the exciter lamp ("light source") passes through the home-talkie film and is reflected, by a strip of highly-polished metal, into the P.E.C.-unit.

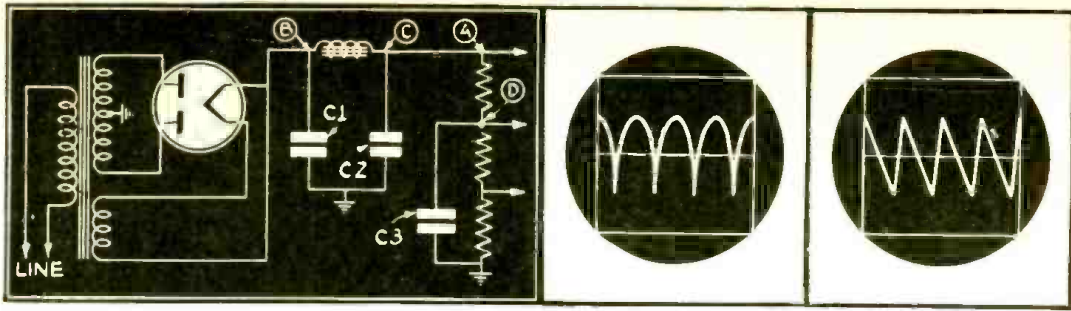

Fig. 2A. Indicating points of check of full-wave rectifier, condenser-input power supply.

Fig. 2B. Correct pattern, full-wave rectifier ~~condenser~~ input.

Fig. 2C. Correct pattern, full-wave ~~condenser~~ input.

CHOKES

CONDENSER

COMPLETE STEP-BY-STEP

Part I in this highly informative series of articles for the radio Serviceman, which appeared speeding service work; and how to set up the oscilloscope portion of the test equipment. Part

KENDALL CLOUGH

In the following dynamic analysis procedure, it is assumed that the power pack is operative. To check this, connect a D.C. voltmeter at the point "a" in Fig. 2A. Since this does not guarantee that the filter assembly is performing correctly, however, the following additional checks should be made.

Section 2 CHECKING POWER SUPPLY PERFORMANCE

Refer back to Section 1, and set the oscilloscope controls as directed to obtain the pattern of Fig. 1D. This will give a sweep rate of 30.

Since all the voltages in the filter are related to the line frequency, time will be saved by locking the linear sweep once and for all to the line frequency. To do this, hold the pattern of Fig. 1D and turn the CONTROL knob to FREQ. Turn up the SYNC. control until the pattern is locked. In this way the sweep is held to 30 per second, irrespective of the frequency of the applied voltage, or, in fact, with no VERTICAL voltage applied.

TESTING THE FIRST FILTER SECTION

Apply the VERT. test prod to the filament or cathode of the rectifier at the point marked "b" in Fig. 2A, showing a full-wave rectifier, condenser-input power supply.

If the circuit under test corresponds to Fig. 2A, and is OK thus far, the pattern of Fig. 2B will be seen when the VERTI-

CAL amplifier control is properly adjusted. This is 4 cycles of the 120-cycle pulse on the input of the filter.

Suppose the condenser C1 is open. The point "b" will then be the connection to a choke-input filter. and the pattern of Fig. 2C will be seen. Since we know from the circuit that it is supposed to be a condenser-input filter, the pattern of Fig. 2C indicates immediately that the input condenser is open.

On the other hand, suppose the pattern of Fig. 2D is seen. This is a 2-cycle pattern, showing a 60-cycle pulsation. This would be the correct pattern for a half-wave rectifier condenser input, but since we know we are dealing with a full-wave circuit, one side of the rectifier *must* be faulty, or one side of the power transformer *must* be open. Replacement of the rectifier tube will determine which.

Figure 2E, showing a half-wave rectifier choke input, completes this group of patterns, 4 in all. You have only (1) to inspect the diagram of the receiver to learn if it is half-wave or full-wave, choke-input or condenser input, and (2) to apply the VERT. test lead to the filament or cathode of the rectifier as instructed, to learn with complete certainty whether the operation of the first filter section is correct or defective, and, if the latter, where.

TESTING THE SECOND FILTER SECTION

Apply the VERT. to test prod to the point marked "c" in Fig. 2A.

Figures 2F and 2G show how the pattern

should appear with full-wave and half-wave rectification, respectively. The important point in this test is not so much the shape of the curve as the amplitude, compared with patterns observed in testing the first filter section. If the filter choke (sometimes the speaker field is used) is OK, and the condenser C2 is in circuit, the amplitude of the pattern at "c" will be smaller than at "b" by about 25 times, in the average receiver.

This difference in amplitude can be checked by the relative heights of the pattern on the screen, or by the number of degrees that it is found necessary to advance the VERTICAL amplifier control in order to hold the pattern to the same size.

CHECKING OTHER FILTER SECTIONS

Apply the VERT. test prod to other points along the bleeder such as "d." Each step should show a successive decrease in the amplitude of the pattern. If condenser C3 across some point of the bleeder is large (1 mf. or more), that point as well as others nearer the chassis should show only a tiny pattern or none with the VERT. amplifier control turned all the way up.

Section 3 VIBRATOR TESTING

A mistaken idea has spread that vibrators can be independently checked for defects and adjusted with the aid of cathode-ray equipment.

This is not true; in fact, the only real

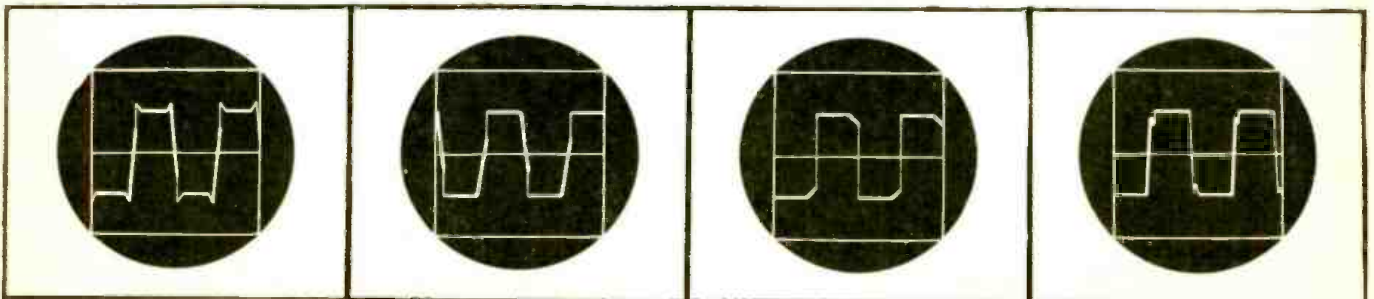

Fig. 3A. Correct image, non-sync. vibrator on load, or sync. type no-load.

Fig. 3B. Correct performance pattern for sync-type vibrator with D.C. load.

Fig. 3C. Non-sync. type on load. Buffer condensers too large.

Fig. 3D. Non-sync. type on load. Buffer condensers too small.

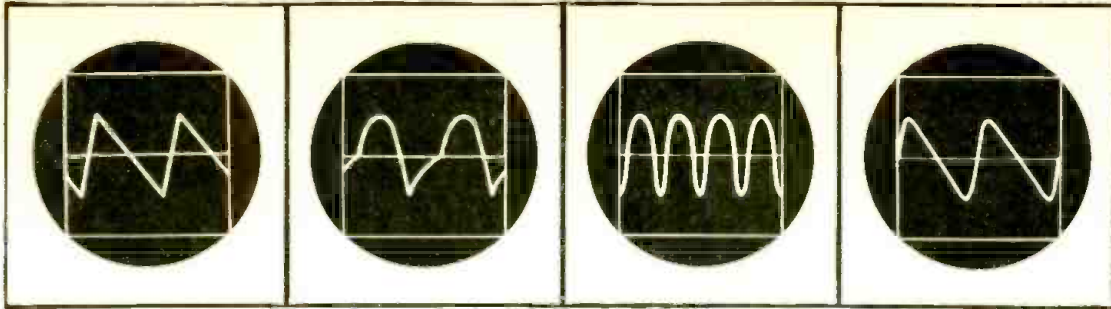

Fig. 2D. Correct pattern for half-wave rectifier, condenser input.

Fig. 2E. Correct pattern for half-wave rectifier, choke input.

Fig. 2F. Second filter section, full-wave rectifier.

Fig. 2G. Second filter section, half-wave rectifier.

DYNAMIC SERVICING

in RADIO-CRAFT last month, told how *Dynamic Servicing* increases earning power by II now tells how to check power supply performance, and how to test vibrators.

PART II

test of a vibrator is in the receiver itself, where it is operating as an interrelated unit with the power transformer, buffer condensers and rectifier, according to original engineering calculation.

Further, while cathode-ray tests provide a quick and revealing dynamic analysis of the entire vibrator circuit as a whole, it is only inviting trouble to attempt adjustments without the fixtures and tools used by the manufacturer.

Usually the best, safest and cheapest procedure for all concerned is to replace a defective vibrator and also possibly to install new buffer condensers, as subsequently noted:

SOURCE OF OPERATING VOLTAGE

In actual operation, the vibrator and its associated circuits are required to deliver smooth D.C. power under all conditions of the car battery, which may vary from approximately 5 to 8 volts. For this reason, 4 cells of battery should be used for test work, together with a rheostat to enable adjusting the voltage to this range.

CONNECTING THE OSCILLOSCOPE

See that no ground is connected to the receiver, and connect the GND. post of the oscilloscope to the center tap of the transformer primary. Connect the VERT. post to one end of the primary.

SETTING THE CONTROLS OF THE OSCILLOSCOPE

Turn the SWEEP control to LINEAR and adjust the HORIZONTAL control until

the trace just fills the scale. Turn the CONTROL to INTERNAL and turn on the receiver. Adjust the vertical control until the pattern is about 1 in. high.

Now, turn the FREQUENCY and VERNIER dials until 2 complete cycles are seen, and lock the pattern with the SYNC. control.

CORRECT OPERATION

Figure 3A shows the pattern indicating correct operation of the non-synchronous, or tube-type vibrator, while Fig. 3B is for the synchronous or self-rectifying type.

Figure 3A shows the flat tops of the trace occupying about 80% of the length of the cycle, indicating good time efficiency, and the slant portion of the trace occupying about 2/3 of the vertical distance. The rest of the up and down trace becomes vertical. (The vertical portion of the trace may not be seen at all without turning up the INTENSITY control a great deal.)

The pattern produced by the self-rectifying vibrator is the same, if the little points at each end of the horizontal traces are considered as being horizontal. These appear in the pattern of a properly operating self-rectifying unit, indicating the closure of the rectifying contacts after the primary contacts are closed. To avoid any confusion due to these peaks, open the D.C. load at the output of the filter. The correct pattern for the synchronous type, operating without D.C. load, will then be the same as for the non-synchronous type with load, as in Fig. 3A.

Caution. In making this test, be certain

that the filter including the first condenser is in circuit.

UNDER- AND OVER-VOLTAGE TESTS

In addition to obtaining the correct pattern shape, the starting voltage of the vibrator should be determined and correct operation assured at over-voltage.

To check the starting voltage, reduce the input voltage from the battery to about 3 volts. Then slowly increase the input voltage to the point where the vibrator starts. Observe the pattern, which should be free from flicker. Repeat this test 2 or 3 times. If the vibrator will not start reliably at 5 volts or less it should be replaced. Also, if the pattern and the output are not perfectly steady after starting, worn contact points are indicated and replacement should be made.

To check at over-voltage after ascertaining that the starting voltage is satisfactory, the input should be advanced to 8 volts. The pattern, although increased in size, should be steady on the screen.

A few minutes of operation at this voltage will insure that the insulation of the power transformer, buffer condensers and filter condensers will stand up under conditions of abnormal car battery voltage. The input should then be reduced to 6.3 volts for all further testing.

BUFFER CONDENSERS

The buffer condensers must not only have satisfactory insulation, but they must be of the correct size. If not, the life of the
(Continued on page 488)

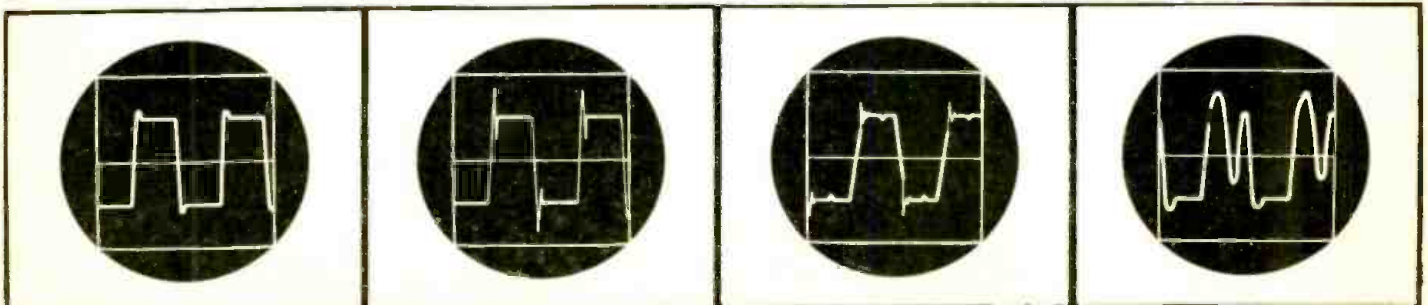

Fig. 3E. Non-sync. type, no-load. Buffer condensers too small.

Fig. 3F. Sync. type, no-load. Buffer condensers too small.

Fig. 3G. Single-footing.

Fig. 3H. Contact chatter.

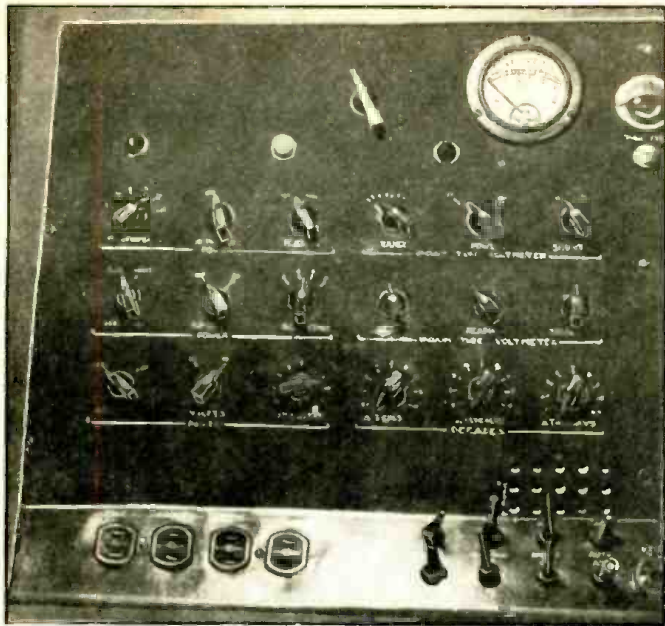

Fig. A. Partial view of instrument panel showing the power-inlet group under discussion, with the associated controls. Several pilot lights are visible, as is the meter of the wattmeter circuit. The 4 outlets are shown in the sloping shelf at bottom. A few of the test cords show. The 3 knobs in the left-hand column control the autotransformer; the top one selecting the voltage tap, the second changing the phase relation, and the bottom being "ON" and "OFF." The flasher switch is the top one in the 3rd vertical column. The top knob of the 2nd column is not truly of this group, yet in use is closely related. Labeled HI-PWR. OSC. ON-OFF, it controls a 40-watt oscillator for breakdown tests on suspected paper and mica condensers, pumping high-voltage high-frequency current through them. The middle knob controls the panel lighting. The bottom knob of Col. 2 changes the wattmeter range. The middle and bottom knobs of Col. 3 control the D.C. input, being the voltage selector switch and the series rheostat, respectively. (The others are not allied with this article.)

Dear Editor:

I am submitting a brief discussion (the article printed here—Editor) of my treatment of Servicing's most annoying problem—intermittents. While not infallible, this system does speed up eighty per cent of such cases so they may be handled profitably instead of merely finally. I have shown an entire power outlet group because it is so closely related.

My observation is that the average shop, like Topsy, just grew. Most Servicemen collect a conglomerate assortment of inadequate portable equipment, haywire it together on makeshift shelves at the back of a carpenter's workbench, then hang out a shingle proclaiming "Service Laboratory." The portable (?) instruments, weighing from 25 to 45 pounds each, are never moved thereafter except for dusting, and need that oftener than they get it. Because of its design for portability such equipment inherently lacks the highly advantageous features of permanent accuracy and interlocking hookup with associated instruments.

The layman, who after all is the man who buys our beans, is not greatly impressed by the ingeniousness of the patented super-gadget in a 2-by-4 case that tests for everything except hoof and mouth disease. He is properly impressed (in the pocketbook) by a clean, coherent, convenient and capable layout.

For 15 years I used the familiar buy, try, and cuss system, then 2 years ago decided to do something about it. Customers entering my shop no longer ask the stock question, "How do you ever find anything?" Instead I am agreeably flattered by such exclamations as "That's really handy" and "I've never seen one like that before." Le femmes say outright, "That's good-looking." Most people say, "It must cost a lot to have the stuff to do the job right." It does. It pays.

Far from being portable, my unit shop measures 4½ by 7 feet, and weighs some 600 pounds. It is a compact analysis bench designed for eye appeal as well as convenience and electrical efficiency. It does NOT have wood-working and blacksmith departments. There is no room for an accumulated museum of radio development. And after 15 years of hunting equipment up and down the usual 30-foot picnic table I've gone on a sit-down strike. The cushioned swivel stool is built into the unit.

Salient features include streamline styling, lumiline panel lighting, and dual spotlight worktop lighting. I have departed from conventional black and brass for a two-tone luminescent blue and silver color scheme, and the panels are symmetrical as a whole rather than a group of esthetically unrelated instruments. Approximately 15 square feet of panel surface is at one's fingertips when in the "operating" position. Every instrument consuming current has a visual

(Continued on page 489)

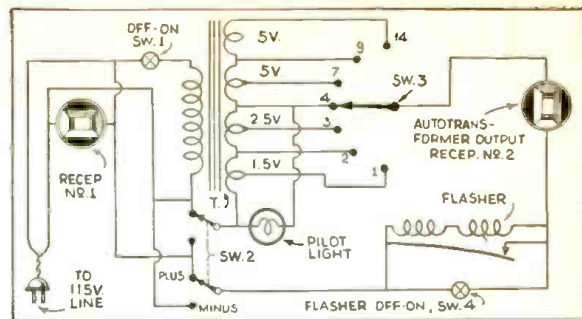

Fig. 1. Connections of the autotransformer, flasher and switches.

KILLING THE

"Permanizing" intermittent operation enough for the Serviceman to localize procedure, the result of 15 years' of this opportunity to help exter-

INTERMITTENTS" waste more time and cause more callbacks for Servicemen than any other one trouble. They may be roughly divided by causes into 3 classes, namely: (1) *thermals*, (2) *surges*, and (3) the *purely mechanical*.

The 1st group is rarely met, and usually occurs as a mechanical imperfection actuated by heat. I find a parabolic electric heater, gingerly directed, to be of some little assistance in locating this trouble. The 3rd group, while most common, is also the most readily located. Discreet probing, prying, and thumping are all that are needed. That *middle group* is the one that calls you to the phone at 9 P.M. to hear that "you can't fix radios worth a —!" Or the man says, "My radio changes volume every time I turn on a light. I think my speaker is leaky."

Believing in the old saw, "Fight fire with fire," I apply overloads to cause the temporary trouble to become permanent so it may be located.

Every radio component is susceptible to surge damage. I have found resistors, condensers, and coils, of all types, that trigger off and on better than a mercury switch. The important thing is to "permanize" the fault:—that is, make the fault last long enough to get a test. I find subjecting the set to a brief but decided overload to be the surest method. This method of overloading, then, is the subject of this article. Figure 1 shows an effective yet inexpensive way of controlling the applied voltages.

"PERMANIZING" EQUIPMENT

My system comprises an autotransformer (home-built), 4 storage cells, and associated switches; and handles autotransformer sets and 6-volt household sets as well as the usual 110V. A.C. type. This set-up must be instantly operable to be very valuable as a time-saver. I made a group of 4 outlets by using two standard dual receptacles and sawing the terminal strip, common to both portions, in two. They are spaced on the panel so they become 4 single outlets, both in effect and appearance (see Fig. A).

The first one is connected directly to the line and is "hot" all the time (see Fig. 1). Outlet No. 2 is connected through the autotransformer and automatic switch and is controlled by 4 switches. The simple and effective pilot light not only serves as a telltale whenever the primary is connected on the line, but lights whenever a set is plugged into No. 2 socket whether the switch is on or off. Receptacle No. 3 is permanently connected through a simple wattmeter circuit (see Fig. 2A). Number 4 receptacle brings D.C. to the panel through switch No. 5 and rheostat R, which may be adjusted for the required voltage (see Fig. 2B). Thus everything is

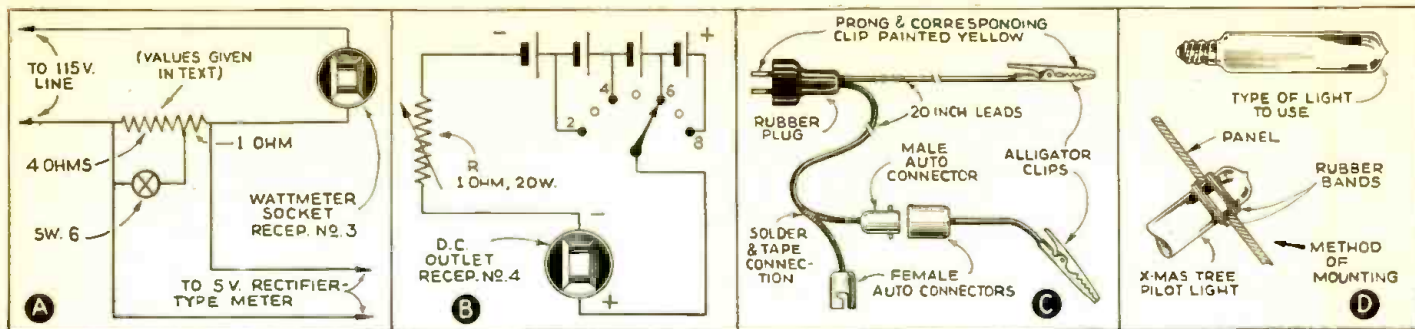

Fig. 2. The simple wattmeter circuit Hookup of the D.C. outlet Details of the D.C. cord Mounting the pilot lights.

"INTERMITTENT" BUG

tion—making the intermittently-operating radio receiver remain non-operative long the fault—is the system Mr. Piety uses to eliminate customer call-backs. The author's servicing experience, is described in detail. RADIO-CRAFT is indeed proud minate the "intermittent" bug—a heretofore annoying and costly plague.

HARL O. PIETY

ready for instant use with no more trouble than the flip of a switch.

AUTOTRANSFORMER

To make the autotransformer, the filament windings of the power transformer are connected series-aiding and tied to one end of the primary in the proper phase relationship.

Perhaps the easiest way of getting the windings correctly connected is to check and mark the voltage of each winding, then tie 2 ends together in the desired sequence and check to see that the voltages add; if not, reverse ends on one winding. Add another section to it, rechecking the same way. A reversed section of winding will cause the transformer to overheat as well as reduce the effective voltage. The only prerequisite of the transformer used is that the sum of the voltages of the secondary windings used shall be equal to the maximum increase or decrease in voltage desired.

Casual inspection does not reveal the current-handling possibilities of the transformer. The rating of the lowest current filament winding in amperes multiplied by 110 (115, etc., depending upon line voltage), the value of the line voltage, gives the approximate watts capacity of the unit. Thus, assuming a 5-volt, 2-ampere rectifier winding to be the lowest, the rating of the transformer in this service will be 220 watts (though it be normally 40 it will stand considerable overloads for short periods).

Referring to the diagram (Fig. 1) switch No. 1 disconnects the unit from the line. Number 2 chooses whether the voltages are to add or subtract by reversing the phase relationship, while switch No. 3 selects the desired tap on the winding.

The automatic switch or flasher, F, is thrown in or out of the circuit by switch No. 4, which shorts it out when

not needed. It often assists materially by increasing the instantaneous surge voltage at the moment of break. A set that will take the flasher on 130 volts for 10 or 15 minutes is not likely to return to the shop immediately. The automatic switch is adapted from a cheap blinker of the type used on Xmas tree decorations and temporary signs. It may be found in almost any variety store.

WATTMETER

The wattmeter circuit in Fig. 2A is crude but practical. It will not give even comparative indications between a neon sign and a motor because it neglects phase displacement, but it is good for practical tests on power supplies. Any 4-tube midget that shows 120 watts has more to account for than mere meter inaccuracy.

It is a very old and simple scheme: just pass the current through a known resistor and measure the voltage drop, calibrating the meter directly in watts. I use a 5-volt A.C. meter.

The dropping resistor is approximately 5 ohms, with a tap at 1 ohm, and is made of an old-style rheostat adjusted for full-scale deflection with a 100-watt bulb in the socket. The tap is located by obtaining full-scale deflection with switch No. 6 closed and a 500-watt load on the circuit. The scale is not linear, but may be calibrated directly by using light bulbs of known watts rating. When possible, use 3 or more bulbs of each size and take the average, since they are not precision resistors. Thus when switch No. 6 is closed one has a 500-watt range, when open the range is 100 watts, and the setup is permanently ready for use.

D.C. OUTLET

The direct current outlet, No. 4 (see Fig. 2B), is connected to the storage

cells through switch No. 5 and rheostat R, which control the voltage. The switch must have good contacts, since it sometimes carries from 10 to 12 amperes. Rheostat R must be capable of dissipating 20 watts.

I show my D.C. cord in Fig. 2C because it is truly universal. A rubber attachment plug is used for durability. The alligator clips attach to all battery sets regardless of supply voltage or type of plug. Only one lead has the auto connector break since an auto radio chassis is always tied to one side of the supply and the clip can be used on it. Reversing the input voltage is merely a matter of reversing the attachment plug, which is not polarized especially for that convenience. One prong of the plug and one clip are painted yellow for quick checking of polarization. The outlet on the panel is appropriately colored red and black to indicate positive and negative.

This arrangement permits quick and positive tests for vibrator worth as well as overload tests on all types of battery sets. Simply touch the test meter prods across the clips, and starting at about 5 volts, gradually increase the voltage until the vibrator starts. If it starts at 5.25 volts, or less, it is good, assuming that the output voltage is fairly steady. If between 5.25 and 5.5 volts potential is required the vibrator is poor and may give trouble soon; and if 5.6 is necessary to start it trouble may be expected immediately. It is a simple matter to insert an ammeter in the clip leads whenever current readings are desired. I do not have one in the circuit permanently because of the difficulty of readily protecting it through the wide range encountered.

Throughout my panel I use standard tubular Xmas tree lights for pilots, as shown in Fig. 2D. The lighter colors
(Continued on page 489)

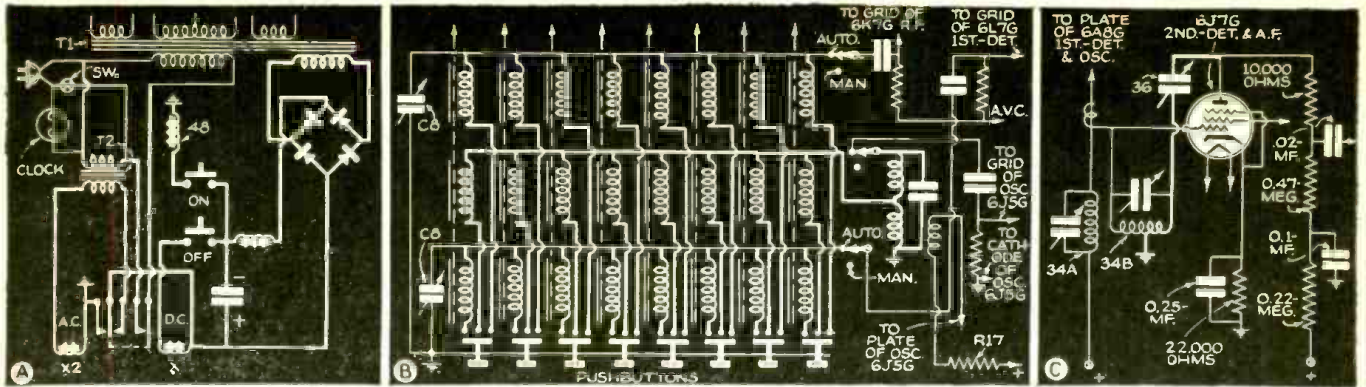

Fig. 1. New circuit details of (A) Motorola, (B) Zenith and (C) Stewart-Warner sets. The heavy lines accentuate the features.

NEW CIRCUITS IN MODERN RADIO RECEIVERS

The details of the modern radio receiver circuits that make them "different" from previous designs are illustrated and described each month by a well-known technician.

F. L. SPRAYBERRY

NUMBER 17

(1) ON-OFF CONTROL BY PUSHBUTTONS

Motorola Models 89K-1, 89K-2, 109K-1 and 109K-2. With this arrangement the set may be turned off or on by local or remote pushbutton control, or by the automatic time tuner — all without changing any station setting unless desired.

The mechanism consists of a power line A.C.-D.C. relay line as shown in Fig. 1A. When the line cord of the set is plugged in, the time tuning clock is permanently connected to the line, while a standby transformer T2 is energized through the main power switch Sw. Depressing the "on" switch closes the 13-volt secondary of this transformer through an A.C. relay solenoid X2, a D.C. relay solenoid X1, the "off" switch which is closed and a solenoid (48) similar to the other solenoids for each station of the magnetic tuning system. Relay X1 unlatches the armature which closes the main power transformer (T1) primary and connects the D.C. solenoid for operation. The off switch then springs open by the regular pushbutton action.

The "off" button energizes the D.C. relay from a bridge copper-oxide rectifier opening the power transformer

primary circuit and setting the A.C. relay.

All pushbutton and time tuning switches, with their respective station selector solenoids are in shunt with the "on" switch and solenoid (48) so that the selection of any station by the time tuner or pushbutton will turn the set on and off automatically.

(2) GANGED TRIMMERS FOR AUTOMATIC TUNING GREATLY SIMPLIFY TUNING ADJUSTMENTS

Zenith Models 9S307, 9S324, 9S344, 9S367 and 9S369. Only one adjustment is now needed with a carrier signal or signal generator to perfectly align any of the 8 stations tuned by pushbutton selection in these models. The same system is used in many similar models.

The inductance variation idea is used for the automatic tuning mechanism of this receiver. In Fig. 1B are shown the 24 inductances with only 8 adjustments indicated by the arrows. Three iron cores of low permeability are mechanically mounted together so that they move in and out of their respective coils simultaneously. Thus for one station the R.F., detector, and oscillator stages are simultaneously adjust-

ed. Trimmers C8 are set and remain at one value while the stations are set up.

(4) DEGENERATION AUTOMATICALLY SELECTED BY VOLUME SETTING

General Electric Models G-61, G-66, G-68, G-69. An output bridge circuit is arranged to provide maximum degeneration at the minimum-volume setting of the volume control; and vice-versa.

Across the voice coil there are 2 resistors as in Fig. 2A having values as indicated of 47 ohms and 22 ohms. Their center point is connected to the high-voltage negative terminal and hence remains fixed in potential. To the end of the voice coil at which the 47-ohm resistor is connected is a lead through a 2.2 meg. resistor to the top of the volume control.

The voltage across R10 (47 ohms) is of such phase as to produce regeneration but it is more than lost across R13. The drop across R17 (22 ohms) is of opposite phase and hence produces degeneration. The degenerative drop across R17 is reproduced roughly across R7, the volume control, as it is an adjacent leg of the bridge. The top of the volume control when C19 is at

(Continued on page 496)

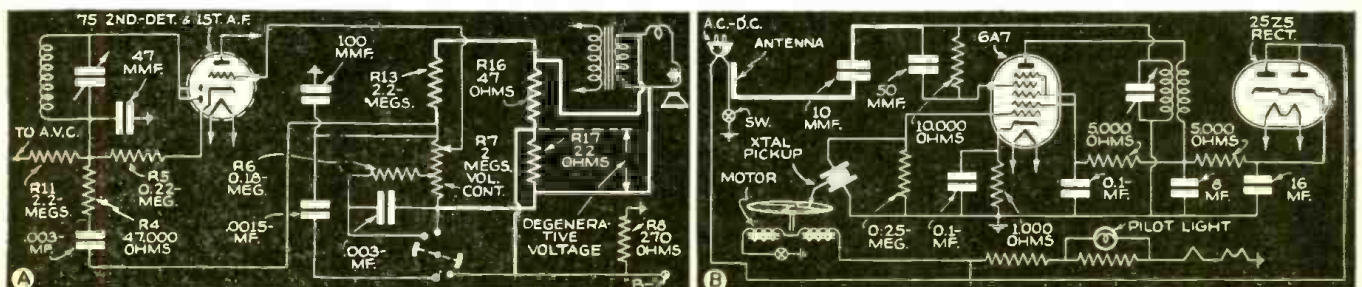

Fig. 2. New circuit features of (A) General Electric and (B) Wilcox-Gay receivers. The heavy lines accentuate the features.

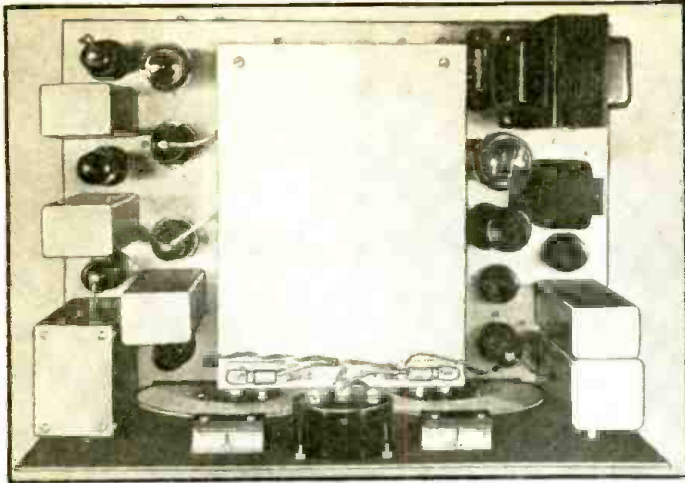

Fig. A. Top view of Hammarlund's new receiver. Tuning and bandspread condensers are inside the can.

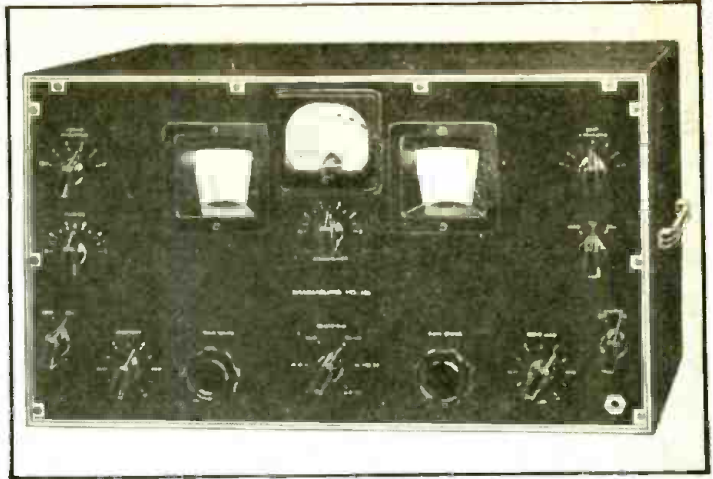

Fig. B. This front view of the HQ-120-X shows the panel lay-out and various controls.

"HQ-120-X" SHORTWAVE RECEIVER

The new 12-tube Hammarlund receiver which this article describes introduces the use of a crystal filter circuit (diagrammed at end of article), developed by the company's laboratories, which makes it possible for the shortwave fan (broadcast listener) to enjoy all the privileges of a crystal filter that hams have been enjoying the past few years. Such voice and music reception with a crystal filter opens up a new field in shortwave DX-ing.

SO many stations are now crowded into the narrow shortwave bands due to the ever-increasing popularity of shortwave broadcasting that the short-wave listener and DX-er

require a receiver with all the fine technical features of a communications set in order to cut through the "hash". Such a receiver is the new Hammarlund "HQ-120-X";—a thoroughly engineered shortwave set illustrated in Figs. A and B, and by diagram in Fig. 1.

CRYSTAL FILTER

Let us briefly discuss some of the important features which required special design and treatment. We will begin with the new *crystal filter* which is an entirely new development.

The conventional crystal filter, while it serves excellently for "single-signal" C.W. reception in crowded amateur bands, does not help the shortwave listener or phone man to any great extent since it tends to slice off some of the voice frequencies, resulting in distortion. Hammarlund's new crystal filter however, has a complete range. Its selectivity is variable from the maximum band width of the receiver to the usual razor-edge selectivity of ordinary crystal filters. The range of this crystal filter is divided into 6 steps including the "off" position. The first 2 or 3 ranges of the crystal filter are suitable for phone use. Position No. 1 even permits a broad enough band width to admit fairly decent musical renditions.

In other words, the shortwave listener with this receiver, can now enjoy the same benefits of the crystal filter which the amateurs have for years been enjoying with their communications jobs.

Number 2 position, while not entirely suitable for music, is perfect for voice reception. While these band widths, which do *not* represent *extreme* selectivity, may be similarly obtained with

ordinary I.F. amplifiers, they can be controlled from the front panel when obtained with the crystal filter. The *phasing*, or *neutralizing*, control serves this purpose.

Further, with an ordinary I.F. amplifier, the usual heterodynes and similar disturbances ride through with the desired signal. Not so, however, with the new crystal filter because this interference can be neutralized or "phased-out" with the front panel phasing control which, in addition, is capable of adjusting the band width of the receiver to cope with existing conditions.

Positions 4 and 5 on the switch are entirely for C.W. or code reception. Position No. 5 represents maximum selectivity. The degree of selectivity remains unchanged regardless of the position of the phasing control. There is no interlocking. Also, the output of the crystal filter is relatively uniform over the entire selectivity range. Attenuation is not apparent when switching from the "off" position to any other point. In other words, the crystal has no effect on the output level of the signal.

SPECIAL TUNING CONDENSERS

The second unusual feature in this receiver is the arrangement of the tuning and bandspreading condenser gangs. Figure C shows both the *main tuning condenser gang*, and the *bandspread condenser gang*. There are 6 individual sections in the main tuning condenser and 9 in the bandspread unit. This method of condenser design is absolutely necessary if uniform gain and bandspread are to be achieved throughout

(Continued on page 506)

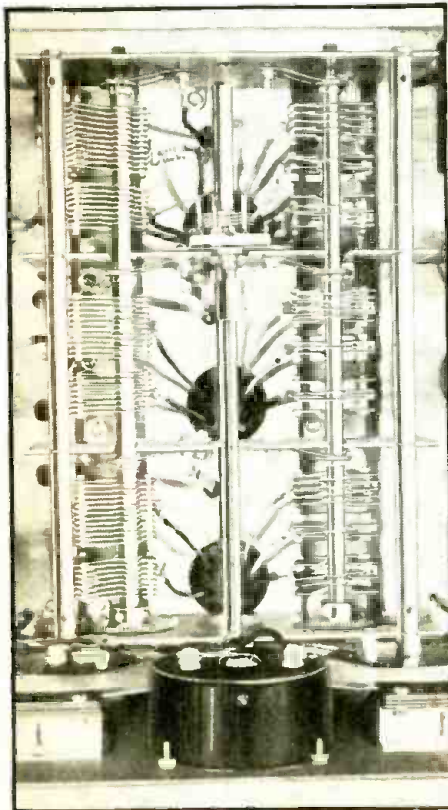

Fig. C. View, showing main tuning and bandspread condenser assemblies. The small condenser in the center, with the extended shaft, is the antenna compensator. Note that there are 3 rotor contacts for each section. These are inlaid, silver-to-silver contacts. The rotors of the 2 large condenser assemblies are hung on ball bearings—one at each end.

MAKING A SERVICEMAN'S TEST UNIT THE "SUPER-GENO-SCOPE"

Here in compact, portable form is a combined oscilloscope, and R.F., I.F., A.F., and modulated (and wobbled) -R.F. and -I.F. oscillator, complete with power supplies. This unit permits visual analysis of any radio set's R.F., I.F., and A.F. circuits.

PART III

CANIO MAGGIO

IN Part I we described the Scope (oscilloscope) section of the Super-Geno-Scope test unit and in a general way described this entire instrument. Part II last month described the Super-Geno portion except for the controls. This month we continue the story where we left off.

A.F. OSCILLATOR (Continued)

The grid-condenser selector connects the condenser between the coil and the grid of the tube to establish the proper timing or the relationship between the charge and discharge of the condenser and the frequency selected. The frequency-condenser selector connects the proper value of capacity to resonate the circuit at the desired frequency. The plate-bypass-condenser selector connects the proper value of condenser to bypass the accumulative plate charges which otherwise would introduce harmonic distortion.

Resistor R26 is a rheostat-type control mechanically coupled to Sw.3. Its use is to vary the resistance of grid-leak R25 in relation to the generated audio frequency. The 3 selectors are mechanically coupled to one common shaft.

The output frequency of the A.F. oscillator has a sine wave characteristic (Fig. 3A-B-C), and the output circuit has a high impedance of the constant-resistance type (R8, C17, J10). Additional characteristics are as follows:

Frequency range 40-7,000 cycles
Harmonic suppression . . . less than 10%
Variable output voltage 0-5 volts
The indicated values of the condensers will vary in accordance with the inductance

value to establish the designated frequencies: 40 - 80 - 125 - 250 - 500-1,000-2,000-3,000-4,000-5,000-7,000 cycles. If the constructor is to retain the same capacity value then the frequency will differ according to the difference of the inductance value. Calibrations of this unit is explained in Part IV.

CONTROLS

The various controls that interconnect the many circuits for the specific diagnoses are briefly described in the order of their functions.

(1) Modulation Selector Sw.4. A 4-circuit, 5-point rotary switch; interconnects the essential circuits to establish the chosen type of modulation.

Pos. 1a—Amplitude Modulation. The source for this type of modulation is the variable A.F. oscillator.

Pos. 1b—Amplitude Modulation 60. The source for this type of modulation is the 60-cycle power line at reduced potential of 6.3 volts.

Pos. 1c—External Amplitude Modulation. For external modulation the source can be from a microphone, phono., A.F. oscillator, etc.

Pos. 1d—Frequency Modulation. The carrier frequency is modulated at a rate of 60 cycles per second (or the oscillator frequency is varied 60 times a second) from minus to plus for the 1st phase, and plus to minus 60 times per second for the 2nd phase.

Pos. 1e—A.F. External. At this position the A.F. oscillator is connected for external use. The A.F. oscillator is valuable in diagnosing audio amplifiers of all types for overall frequency characteristics, gain per stage, loudspeaker frequency response, etc.

(2) % Modulation. This unit, resistor R8, is a constant-impedance attenuator for controlling the intensity of the modulating source. It also acts to attenuate the signal amplitude of the A.F. oscillator when it is used for external audio frequency diagnoses.

(3) Channel or Band-width Control. When frequency modulation is used, this unit, R3, is the attenuator of the exciting voltage (60 cycle) for the operation of the frequency control tube.

(4) Band R.F. Selector. This selector, Sw.6, is of the shorting type. It will short all coils except the one needed to establish the frequency band used. The rotary switch has 2 single-circuit selectors of the "make" contact type, and a shorting or "break" section which has all contacts shorted except the one used.

(5) The A.F. Selector. Switch Sw.3 will select any one frequency of the 11 audio frequencies used.

(6) The Main Line Switch. This switch, Sw.9-K, is of the key type, the advantage for this type of switch is that no other person can use the apparatus except the one person that the key has been entrusted to.

(7) The R.F. Selector. This unit, C49, will select any one frequency within the coverage of the selected band.

(8) Coarse R.F. Attenuator. A 3-point toggle switch, Sw.5, connected with resistance network R19-20-21-22. This system allows better attenuation of the radio frequency voltage or signal strength.

(9) Vernier R.F. Attenuator. Resistor R18 provides a vernier control between the selected taps of the coarse attenuator.

CONSTRUCTION

The various photographs of the unit (Figs. A and B in Part I, and Figs. C and D in Part II) will give an approximate conception of the layout of the necessary parts and chassis design.

On the front panel (See Fig. A, Part I) we have the following controls from left to right, top to bottom.

Vertical Spot Control, Focus, Intensity, Horizontal Spot Control, Synchronization Selector, Vertical Amplifier ON or OFF, Trace Eliminator, Horizontal Amplifier ON or OFF Switch, Sweep or Timing Selector, Vertical Gain Control, Synchronization Control, Fine Frequency Control, Coarse Frequency Selector, Horizontal Gain Control, Mod. Selector, % Mod., Main Line Switch, Kc. Band-width Control, R.F. Band Selector, A.F. Selector, Coarse R.F. Attenuator, Fine R.F. Attenuator, R.F. Selector.

The case measures only 11x12x8 inches; chassis design and dimensions are given in Fig. 4.

Parts mounted on top of subpanel of the oscilloscope section (See Fig. B, Part I): power transformer, filament transformer, synchronization transformer, tubes V1, V2, V4, V5, and cathode-ray tube V3 (mounted horizontally at upper-center of panel). Left and right of the C.-R. tube are coils L1-L2.

Parts mounted below subpanel of the oscilloscope section: condenser block mounted directly under cathode-ray tube, filter choke mounted directly over power transformer terminals on the uprights, all resistors and condensers are mounted directly to, and between, the various controls.

The wiring of the units is of the progressive type, that is, all filaments and the rectifier tube connections are wired first. Wire controls R14, R10, and Sw.4, before mounting the condenser block. All wiring begins at the front panel and advances progressively. All connections should be mechanically secured, clean and well-soldered, and the subpanel kept free of loose solder.

Wiring of the oscilloscope should be completed and tested according to operating

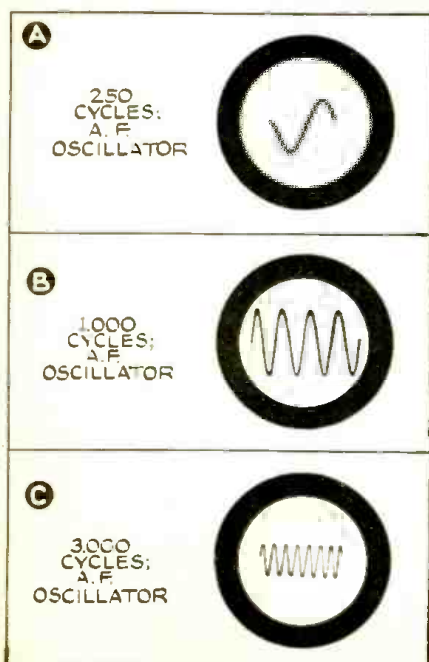

Fig. 3. The A.F. oscillator output is a sine wave.

characteristics before commencing and mounting wiring of the necessary parts for the Super-Geno section of the unit.

The subpanel of the signal generator (see Fig. D), as shown in the bottom view photograph, is cut to fit the various shields; these are the shields of the A.F. oscillator assembly, R.F. output circuit assembly, and the necessary cut-out of the tuning condenser.

Mounted on top of the subpanel of the Super-Geno section (see Fig. C) are: at right the power transformer and filter choke mounted directly over it, 80 rectifier, 6J7 frequency control tube, 6J7 fixed R.F. oscillator and the variable R.F. oscillator assembly. Behind the frequency control tube is the A.F. oscillator transformer and tube, and behind the A.F. oscillator tube are the oscillator assembly and 6K8 modulator tube.

The variable R.F. oscillator assembly consists of the R.F. choke and condenser L11 and C48, grid condenser C35, and the 6 inductances L5-L6-L7-L8-L9-L10, air trimmers and shunt capacities, band switch and tuning condenser.

The R.F. output circuit assembly includes units L12, R24, C21, R18, R19, R20, R21, R22, Sw.5, J9.

TABLE III—COIL WINDING DATA

VARIABLE R. F. OSCILLATOR HET. FREQ. OUTPUT

Band	Frequency Range	Winding Data
Band 1	85- 325 kc.	985-1,225 kc. pri. turns—28, No. 32 D.C.C. (L5) sec. turns—74, No. 30 enam. fixed shunt capacity, 250 m m f. (C37)
Band 2	300- 1,100 kc.	1,200-2,000 kc. pri. turns—23, No. 32 D.C.C. (L6) sec. turns—70, No. 30 enam. fixed shunt capacity, 70 m m f. (C39)
Band 3	1,000- 3,000 kc.	1,900-3,900 kc. pri. turns—18, No. 32 D.C.C. (L7) sec. turns—45, No. 28 enam. fixed shunt capacity, 50 m m f. (C41)
Band 4	3,000- 7,000 kc.	3,900-7,900 kc. pri. turns—10, No. 32 D.C.C. (L8) sec. turns—20, No. 26 enam.
Band 5	7,000-15,000 kc.	6,100-14,100 kc. pri. turns—8, No. 32 D.C.C. (L9) sec. turns—12, No. 22 enam.
Band 6	15,000-32,000 kc.	14,100-31,000 kc. pri. turns—8, No. 32 D.C.C. sec. turns—7, No. 18 enam., single-spaced Coil form: 9/16-in. dia.

FIXED R. F. OSCILLATOR

- L3: pri. turns—98, No. 32 D.C.C.
- sec. turns—190, No. 32 D.C.C.
- L4: sec. turns—205, No. 32 D.C.C.
- L3, L4: lattice-wound, 3/16-in. wide; coil form, 1/2-in. in dia.

The A.F. circuit assembly Sw.3 and its associated condensers and resistors are as shown in the diagram.

The phase inverter condensers C10, C11, C12 (notice rear of subpanel) are totally shielded when enclosed in the case.

The front controls are wired first, also the A.F. oscillator assembly is wired completely with leads protruding from assembly, likewise the R.F. output circuit is wired before mounting subpanel. The condenser block is mounted under the variable R.F. oscillator assembly.

For the remainder of the wiring follow same instructions as given in the Scope (oscilloscope) section

The tube terminal voltages of the completed Super-Geno section may be checked at once against the operating values, obtained by the writer in his original set-up, as given in Table II (Part II).

OPERATING THE SCOPE

Actual operation of the Scope (oscilloscope) section of the Super-Geno-Scope is simple.

With the tubes placed in their sockets the unit is ready for operation. Turn the key switch, the main line switch, Sw.9-K, to the ON position. Scope line switch, Sw.7, is mechanically-coupled to R26, the intensity control.

Assuming the operator does not possess a signal generator (amplitude-modulated from a sine wave audio source or audio oscillator), he can use the sine wave of the power lines at a reduced potential of 6.3 volts or any arbitrary voltage. This will permit the operator to become accustomed to the various controls of the oscilloscope.

At first a dot*, created by the beam of electrons, appears on the screen. This is the basic operation of the tube. With no input made on the vertical- or horizontal-deflecting circuits, and with the Sweep Selector at OFF position, correct spot size is attained by proper adjustment of the Focus and Intensity controls. Note that the spot has to be uniformly round (without any jagged edges). Also this spot has to be properly centered by adjusting R15-R16.

Then we introduce the sweep voltage (Int.). This will appear as a straight line on the horizontal axis.

If we use the 60-cycle line frequency for the vertical input, this will show some parallel lines; or odd, short lines at various fixed angles until the proper controls are adjusted. The controls (a) are the Coarse Frequency Control of the sweep oscillator, Sw.4 (which is set at position 1-2), and (b) the Fine Control, R-14 (which is varied until a tracer appears, tracing 1-2-3 cycles). The lock-in control or Synchronization Control is advanced until the image remains stationary upon the screen.

With a 60-cycle signal voltage at the Vertical Input, the Synchronization Selector can be set at either Internal or 60-Cycle. It should be understood that this 60-cycle sync. voltage is not the sweep voltage. All it does is to actuate the sweep oscillator (depending upon the frequency setting) to generate sawtooth pulsations which are multiples or submultiples of 60 cycles, or whatever the frequency of the power line operating the oscilloscope unit may be.

This practical experience of the operation of the oscilloscope, with a 60-cycle at V

***Warning:** A sharp, intense spot is not to be prolonged on the screen, as this will cause irreparable damage to this tube. As the operator becomes experienced in the use of the oscilloscope he will soon discard the *spot method* and use instead the *horizontal-line method*.

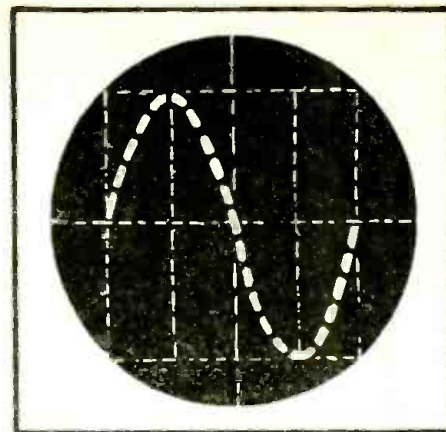

Fig. 5. The maximum correct size of image.

input, will give the operator a good approximation of the sine waveform. The operator is able to note the presence of more than one cycle thus knowing the waveform or the tracer form of the pattern that any continuation of more than one cycle would be into the succeeding cycle.

The Harmonic Sweep or 60-cycle sweep, possesses limited utility in that it can not be used for the examination of waveforms other than those at frequencies which are multiples or submultiples of 60 cycles. However, knowing the accurate frequency of the power line, the harmonic sweep can be used as a frequency standard for calibration work at audio frequencies.

The amplitude or dimensional controls of the image are adjusted until a sizeable image is had or properly squared (framed) as in Fig. 5.

SUMMARY OF THE MAIN POINT OF OPERATION

- 1—Establish a tracer that is properly focused and centered.
 - 2—H-input (the sweep frequency) should be a submultiple of the V-input frequency.
 - 3—The shape of the H-frequency wave should be a linear sawtooth to avoid double exposure.
- Synchronization—(A) Internal, when a small part of the voltage under observation is used for the lock-in.
 —(B) 60 cycles, voltage under observation is a multiple or a submultiple of 60 cycle.
 —(C) External.

(Continued on page 495)

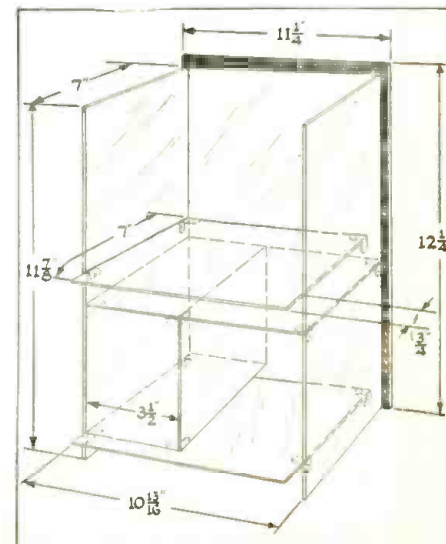

Fig. 4. Chassis specifications.

Is Public Address

Equipment Overrated?

At the request of RADIO-CRAFT the Chief Engineer of a manufacturer specializing in sound and recording equipment has prepared for our readers one of the most informative articles it has ever been our pleasure to present. Manufacturers as well as practitioners in the sound field are here given the "low down" on sound equipment by a man who knows many of the answers.

ARTHUR W. NIEMANN

THE wide-awake Public Address man of today will insist on definite and accurate information from the manufacturer concerning the equipment which he uses in his business. He must know the frequency range of all component parts of the system: the power capacity and distortion content, and the gain and volume range of amplifiers; the power capacity and efficiency of the speakers; and, the efficiency of the microphones.

Without this information the Public Address man is in the position of a builder who doesn't know the proper ingredients for his concrete, or the civil engineer who knows nothing about the strength of the materials he has to work with.

RATINGS DIFFER!

A considerable amount of confusion can result from lack of uniform practice in rating Public Address equipment. It is confusing to compare 2 amplifiers with equal rating and find one delivering a considerably higher power than the other; or to compare 2 amplifiers with the same rated gain and find one is adequate for a certain purpose while the other fails by a few db. to give the required amplification. Such conditions result when manufacturers fail to follow the same procedure in rating equipment.

DISTORTION RATING

One manufacturer might rate an amplifier at its maximum power output without regard to distortion, while another follows a more conservative picture in rating. There is no such thing as a distortionless amplifier. The important question then is, how far down in db. is the total distortion content with respect to the output power for any given output level?

If the distortion is 30 db. or more below the output level, only the most skilled and discriminating ear can detect it by listening. This corresponds to about 3% total harmonic content of the output current. In most cases 5% harmonic current content is acceptable as distortionless output although a large percentage of the listeners can detect some degradation of quality when this much distortion is present. In such a case the power in distortion products is 26 db. below the output level. When the distortion rises above this value there is a marked impairment of quality.

For Public Address work the first consideration is intelligibility of speech. The distortion content which may be tolerated before the intelligibility becomes impaired is considerably above the 26 db. point. However, long before the intelligibility is impaired the quality becomes harsh and rasping and produces a distinctly disturbing and unpleasant sensation. Many Public Address men are not fully alive to the importance of the impression thus created or the desirability of avoiding the unfavorable, though perhaps subconscious, opinions which result in the minds of the listeners. Some manufacturers, though, are not averse to making exaggerated

claims for the power capacity of their equipment and then letting the Public Address man bear the brunt of the adverse opinion created by his attempts to do a job with wholly inadequate equipment.

POWER GAIN AND FREQUENCY RANGE RATINGS

Concerning the power gain and frequency range of an amplifier there is less chance for misrepresentation because both can be measured without unduly complicated measuring equipment and the chance of the manufacturer's meeting with flat contradiction from a wide-awake buyer is correspondingly increased. However, there is one point concerning the gain of an amplifier using no input transformer which should be made clear.

The gain of an amplifier in db. is:

$$N(\text{db.}) = 10 \log_{10} \frac{P_2}{P_1} \quad (1)$$

Where P_2 is the power delivered to the load impedance and P_1 that delivered to the input impedance. The output resistance load is always known and the power is:

$$P_2 = R_L i^2 = \frac{e_2^2}{R_L} \quad (2)$$

Where R_L is the load resistance, i is the r.m.s.



Fig. 1

current in this resistance, and e_2 the voltage across the resistance. The input power is:

$$P_1 = R_1 i^2 = \frac{e_1^2}{R_1} \quad (3)$$

Where e_1 is the input voltage, R_1 the input grid resistor and i the current through this resistor. For a given input voltage source the input power can be made very small by using a high-resistance gridleak. Hence the gain of the amplifier as given by (1) will appear larger in spite of the fact that the output voltage will not be increased by this device after the input resistance has been increased beyond that of the source.

The gain of the amplifier is really increased but there is an exactly corresponding mismatch loss between the generator and the grid resistance, which is the generator load. Hence, when no input transformer is used no appreciable gain can be obtained through use of a grid resistor greater than about twice the resistance of the generator used. Therefore, the amplifier gain should be computed using as a grid resist-

ance the resistance of the voltage source to obtain the effective gain of the amplifier when used with such a source.

To make this point clear let us consider an amplifier intended to be used with a reproducer having an impedance of 10,000 ohms, into a speaker having a 10-ohm coil, and having an over-all voltage amplification of 1,000. Suppose the manufacturer used a 200,000-ohm gridleak and computed the gain of the amplifier from equation (1). The result is:

$$N(\text{db.}) = 10 \log_{10} \frac{e_2^2}{R_L} = 20 \log_{10} \frac{e_2}{e_1} + 10 \log_{10} \frac{R_1}{R_L} \quad (4)$$

or $N = 60 + 43 = 103$ db.

However to work a generator of 10,000 ohms impedance into a 200,000-ohm resistor will give a mismatch loss which can be computed as follows:

Consider the circuit of Fig. 1. The current flowing in such a circuit is

$$i = \frac{e}{R_g + R_L} \quad (5)$$

The maximum power which such a generator can deliver to any load is obtained when $R_L = R_g$. In this case:

$$i = \frac{e}{2R_g} \quad (6)$$

$$P_{\text{max}} = R_g i^2 = \frac{e^2}{4R_g} \quad (7)$$

The power delivered to any other load resistance R_L is

$$P_L = R_L i^2 = \frac{R_L e^2}{(R_g + R_L)^2} \quad (8)$$

The mismatch loss is given by

$$\alpha = 10 \log_{10} \frac{P_{\text{max}}}{P_L} = 10 \log_{10} \frac{(R_g + R_L)^2}{4R_g R_L} \quad (9)$$

For the case where $R_g = 10,000$ ohms and R_L is 200,000 ohms we have

$$\alpha = 10 \log_{10} \frac{4.31 \times 10^{10}}{8 \times 10^9} = 10 \log_{10} 5.4 = 7.3 \text{ db.}$$

Thus to use the amplifier with this microphone as a generator results in this mismatch loss which reduces the effective gain from the 103 db. computed above to 95.7 db.

If the amplifier gain is recalculated by (1) using 10,000 ohms as the input resistance we get $N =$

$$60 + 30 = 90 \quad (10)$$

The greatest possible net increase in gain which
(Continued on page 498)

OPERATING NOTES

ANALYSES of RADIO RECEIVER SYMPTOMS

SERVICEMEN—What faults have you encountered in late-model radio sets? Note that RADIO-CRAFT will consider your Operating Notes provided they relate to characteristic (repeatedly encountered) faults of a given set model. Payment is made after publication of the Operating Note.

Trouble with . . .

. . . ACRATONE ROYAL MODEL 9A

Receiver inoperative and continued blowing of the A.C. line fuses, caused by a shorted bypass condenser in the plate circuit of the 25Z5 rectifier tube. This condenser connects not only to both plates of the 25Z5 but also to one side of the A.C. line; the other side connecting to the chassis and A.C. power line which is at ground potential. Value, 0.1-mf. Oscillation is traced to the 2nd R.F. circuit and is easily remedied by turning the 2nd R.F. coil at right-angles to the antenna coil, or vice versa.

. . . ATWATER KENT MODEL 53A

Oscillation due to receiver out of alignment or the twisted lead around the control-grid of the 75 2nd-detector and 1st audio frequency tube. This twisted lead controls the feedback in the 75 tube and should be adjusted until the oscillation just stops. If this adjustment does not cure it, then it is necessary to realign the receiver. The I.F. adjustment is 450 kc.

. . . A.K. AUTO-RADIO MODEL 776

Receiver inoperative due to an open or defective electrolytic condenser. This is a dual unit, capacity 4-8mf., 300 volts. Replacing same cures the trouble. Inoperative tone control caused by no contact at tone arm or a poor 41 2nd audio frequency tube. Check 10-ampere fuse inside of connector. Check cable contact to grounded terminal of storage battery for loose connection causing static or hash when car is operating. Sometimes it is necessary to add a drop of solder to the fuse ends to insure a good electrical connection, and at the same time to file off the extra solder, slightly, so as to make a good, flat connection overcoming this difficulty. This should hold true for other receiver fuses as well.

. . . PHILCO MODEL 11

Set inoperative, due to a shorted electrolytic condenser in the power pack. Capacity, 4-8 mf., dual unit. Also replace 84 rectifier and check vibrator points for arcing; if such, replace vibrator buffer condensers, capacity 0.05-mf. It may also be necessary to replace vibrator points, if the points are pitted. Change the value of the buffer condenser when installing new vibrator points.

To determine the correct buffer condenser capacity in a *non-synchronous* unit proceed as follows: remove 84 rectifier tube from the receiver, and place an ammeter in series with the primary (input) of the vibrator unit. Note the ammeter reading and then apply an additional buffer of 0.01-mf. If the ammeter reading decreases, then the buffer condenser in the receiver is open or of insufficient capacity. By adding additional values of buffer condensers in small values until the ammeter swings up, the

correct buffer condenser capacity will be the capacity used when the ammeter reading is at its lowest point.

The same routine is followed in testing *synchronous* vibrators, there being no rectifier to be removed; the output circuit is left open instead, and the ammeter reading closely noted.

GEORGE F. BAPTISTE

. . . STEWART-WARNER MODEL 97-56 CHASSIS

This chassis is equipped with a special sensitivity control trimmer on the back of the set so that the receiver can be adjusted to have maximum sensitivity on the customer's aerial.

The control is adjusted to an average position at the factory, but to get maximum performance, the control should be adjusted when the set is installed in the customer's home. **IMPORTANT:** The adjustment must be made with the set connected to the aerial with which it is to be used.

The sensitivity control is the center trimmer condenser of the 3 mounted on the back of the chassis. In most receivers, a hole is provided in the center of the back of the receiver cabinet, so that this trimmer screw is easily reached without removing the back. In a small percentage of the sets, no hole is provided, and in these sets, the back must be removed to adjust this trimmer.

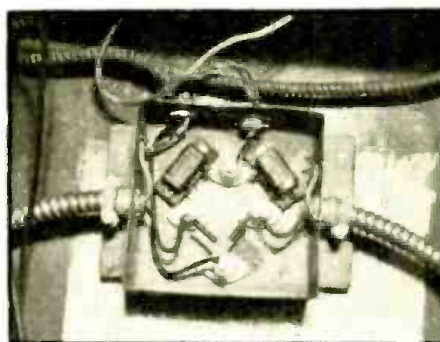

Fig. A

To adjust the sensitivity control, proceed as follows:

Connect the receiver to the aerial and tune it to a fairly weak station preferably at the low-frequency end of the dial. Then, set the volume control so that the volume is fairly low.

Now, using an insulated screwdriver, turn the sensitivity control trimmer *clockwise*. The sensitivity will increase up to a certain point at which the set will begin to squeal. Turn the screw back until the squeal disappears and the tone quality is good. In making this adjustment, keep turning the volume control down so that the set will not overload. If this is not done, you may confuse the overloading with oscillation.

Check operation of the set over the entire dial scale with the volume control turned to maximum volume position. It should be understood that under this condition many of the stations will be badly distorted because of overloading. If there is oscillation (squealing) on any part of the dial, turn the trimmer to the left (counterclockwise).

J. N. GOLTEN,
Service Department,
Stewart-Warner Corp.

. . . INDUCTIVE PICK-UP IN "TALKIE" SYSTEM

Herewith is an article I have prepared entitled "Eliminating Inductive Pick-up in the Photocell Circuits of a Motion Picture Sound System." The problem which confronted the author and its solution should be of interest to a large number of radio Servicemen, as I know of 3 specific instances in this locality where radio Servicemen have been called upon to correct troubles of this nature recently.

Although a probable majority of the motion picture theaters have sound systems that either have preamplifiers located at the projectors, or utilize photocell transformers at the projectors and thence a low-impedance line to the amplifier, there are a large number of theaters, especially in our smaller towns, where a local radio Serviceman is often called upon to make repairs, wherein the photocells are coupled directly through a high-impedance line to the amplifier. It is with the latter type that inductive pick-up in the photocell circuits, and its elimination will be herein discussed.

Inductive pick-up, if at a low level was not necessarily objectionable, and in many cases was unnoticed until the introduction of the *bilateral variable area* and the *variable-density squeeze* tracks, and the lower recording levels now being maintained, necessitating the raising of the gain control far beyond the settings formerly used.

The photocell leads on such sound systems are generally a flexible cable composed of a stranded copper wire with $\frac{1}{4}$ - to $\frac{1}{2}$ -inch rubber insulation and an outer covering of tinned braided copper.

In addition to the photocell leads being highly sensitive to inductive pick-up, the polarizing resistors and coupling condensers, which are, as a rule, in a system of this nature, located in the amplifier, and are just as susceptible or more so than the photocell leads, as due to space being at a premium they are not sufficiently isolated from the other amplifier components.

The writer solved the problem of isolating the condensers and resistors by mounting them in a metal box 6 x 6 x 3 ins. deep (see Fig. A), located directly underneath the amplifier. To make short-circuits a re-

(Continued on page 502)

THE LATEST RADIO EQUIPMENT

The address of any mentioned manufacturer will be sent on receipt of a self-addressed, stamped envelope. Mention of item number hastens reply.

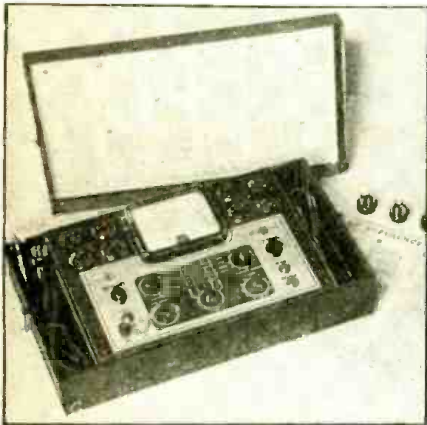

New "Unilyzer" Tester. (1712)

NEW "UNILYZER" TESTER (1712) (The Clough-Brengle Co.)

THIS unit combines 2 complete instruments, viz., plug-in socket analyzer and point-to-point unimeter, instantly convertible from one to the other. Twenty-nine meter ranges including capacity and output in A.C. volts or decibels are available through the use of only 2 switches; one of which exclusively selects the function and the other the range. The first switch automatically shuts off the receiver power when thrown to resistance or capacity position. A safety button keeps the meter isolated at all times except during measurement.

Additional time-saving features are: (1) only 2 binding posts for point-to-point checking; (2) polarity-reversing switch; and (3) single zero-set for resistance and capacity scales. Accompanying reference chart locates and identifies elements of over 450 types of receiving tubes for measurement of current, voltage, resistance or capacity in the circuit of any of the socket terminals. Only 2 rotary switches provide all socket connections.

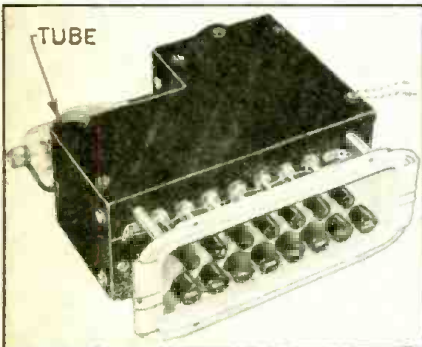

Pushbutton converter. (1713)

PUSHBUTTON CONVERTER (1713) (Meissner Manufacturing Co.)

THIS unit provides a complete pushbutton tuning system for any superheterodyne receiver with an intermediate frequency of approximately 456 to 465 kc. It uses a 6A7 or a 2A7 tube as mixer and oscillator. Connection is made directly to the I.F. channel of the receiver, the R.F. portion remaining undistorted and unused. Both plate and heater power are obtained from the receiver itself. Adjustments for each station are made directly from the front, requiring no tools.

The application of this unit is independent of the number of tuning condenser sections as well as the number and type of wave-band switch. Further, the tuning dial of the receiver need not be set to any particular point in order to use the pushbutton converter.

DUMMY-ANTENNA RESISTOR "TUBE" (1714)

(Ohmite Manufacturing Co.)

BUILT like a vacuum tube, with a glass bulb and 4-prong ceramic base which mounts in a standard tube socket, this new dummy antenna resistor provides a simple, accurate and convenient means for checking the output and accuracy of high-frequency radio transmitters used in amateur, aviation radio communication, police, and

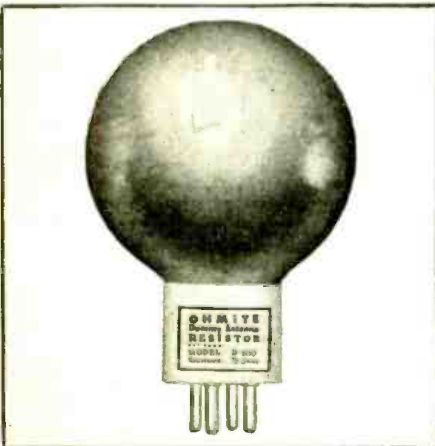

Dummy-antenna resistor "tube." (1714)

broadcast services. Its use permits stage-by-stage checking and insures tuning for peak efficiency. It further eliminates the necessity for creating interference during periods of tuning-up and adjustment.

The unit is non-inductive and non-capacitive therefore maintaining its resistance (and impedance) constant within a very few per cent at any frequency up to 14 megacycles (20 meters) and even beyond. The unit is rated at 100 W. and has a resistance of 73 ohms. The output of the transmitter is simply determined by Ohm's law—the square of a current through the dummy antenna (measured with an R.F. ammeter in series with the resistor) multiplied by the resistance of the dummy antenna (73 ohms). Bulb is gas-filled at atmospheric pressure.

TAP CHANGE SWITCH (1715) (American Phenolic Corp.)

THIS is a compact, 8-position, single-pole switch for impedance matching, universal power transformers, circuit selection on oscilloscopes and similar applications. The base is of molded bakelite, contacts are brass, switch arm phosphor bronze. All electrically charged metal is shielded by a snap-on cover. A side set-screw locks switch in position, eliminating accidental tap changes. A contact indicator is visible through a window in the cover.

NEW TUBE TESTER (1716) (Precision Apparatus Co.)

THIS unit is a pushbutton-operated dynamic-mutual-conductance tube tester combined with A.C.-D.C. volt-ohm-decibel-milliamper-ampere ranges. Its ranges are as follows: 4 A.C. and D.C. voltage ranges at 1,000 ohms/volt: 0-10, 0-50, 0-250, 0-1,000 V.; 5 current ranges (D.C.): 0-1, 0-10, 0-50, 0-250 ma., and 10 amperes; 4 resistance ranges: 0-400 ohms (20 ohms center) Shunt Method, 0-0.1-meg. (800 ohms center), 0-1 megohm (8,000 ohms center), 0-10 megohms (80,000 ohms center).

All ohmmeter ranges powered by self-contained supply. A 4½-V. battery powers all but the 10-meg. range. Four decibel ranges from -10 to +55 db., 0 db., +14 db., +28 db., +40 db.; 4 output ranges: 0-10, 0-50, 0-250, 0-1,000 V.; paper condenser leakage tests (neon method). Provision for measuring leakages of all types of electrolytic condensers directly on the meter in terms of current. Portable type (illustrated) has hardwood carrying case. Compact in size, only 12¼ x 11½ x 6 ins. Approximate carrying weight, 12 lbs.

(Continued on page 503)



Tap change switch. (1715)



New tube tester. (1716)



Magnetodynamic phono pickup. (1717)

All the worthwhile
Radio Trade News
of the past Month—
Digested for busy
radio men.

RADIO Trade Digest

A PLEDGE: — To
print the important
news of the radio
industry; to review
major news events;
to help point a path
to radio profits.

IMPORTANT HAPPENINGS OF THE MONTH IN THE RADIO INDUSTRY

No. 6

FEBRUARY, 1939

No. 6

RMA REORGANIZES ENGINEERING WORK

*More Effective Operations
Promised By Set-Up
Under Dr. Baker*

Dr. W. R. G. Baker of G-E, Bridgeport, Conn., heads the reorganized Engineering Department (it used to be "Committee") of the Radio Manufacturers' Assn., with V. M. Graham of Sylvania, Emporium, Pa., Chairman of the Standards Committee, as his assistant.

The Board of Directors approved elaborate rules for the new set-up, highlights of which follow:—

Standardization Procedure

Material for standardization may be proposed by any of the Committees in
(Continued on page 508)

Helps Cut Coil Stocks

A new coil repair & rewinding service, offered by the Meissner Mfg. Co., Mt. Carmel, Ill., will help dealers & Servicemen keep their replacement coil stocks & inventories at unprecedented lows.

Meissner guarantees prompt & efficient service. Price will be \$1 per unit. Coils will be repaired wherever possible, but if this cannot be done, a new coil will be made at the same price.

Defective coils must be sent in with all available data, in order to minimize delay.

U. S. TELEVISION SHOWS TO BEAT BRITAIN'S BEST, SAYS SAGALL

*Competitive Set-up in States Will Aid Progress;
Movie Experience Highly Valuable,
British Expert Avers*

DUE HERE SOON



When 20" x 24" screen of this Scophony television set is removed, still larger pictures are projected on wall. Inserted on screen by RTD is pic of Solomon Sagall, head of the British co. Sets & Sagall are expected in U. S. early this Spring.

Despite the late start America is getting in bringing telly to the public, it will probably leap into the forefront in the new art, according to the dynamic Russian-born British citizen, Solomon Sagall, here to organize an American affiliation of Scophony, Ltd., the English television co. which he heads. This will be due to struggle to produce best possible entertainment by competing chains & indies. Also to interest of movie cos. centered in world's film capital, on West Coast.

As far as Sagall's outfit is concerned, Britain's chief contribution will be the invention of the apparatus used to produce his large-screen (20 x 24 in.) home television images; America's share will be bringing it to a point where it may be produced at a price to compete in the retail market. He predicts that this 39-tube job will sell at about the same figure as U. S. sets which provide pictures only about 8 x 10 in.

In an exclusive interview, RTD's reporter learned many of Scophony's plans for the U.S. Much of the data was confidential & "off the record," but it may be disclosed that arrangements are under way for a unique spot-news tie-
(Continued on page 508)

SANTA TOOK TIME OUT



Clever display by Philco tied-up Xmas spirit, mystery control & sense of humor, showing busy Saint taking it easy in spare time. Display was lithoed in full color on 3 pieces; featured model 116RX.

ADVERTISES TUBES, TOO

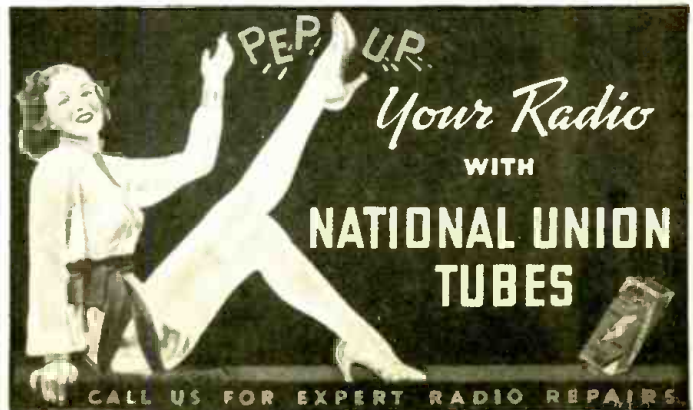

Looking more like an ad for the local burley-kew house than for tubes, this National Union 6-color banner stopped crowds & caught masculine eyes. RTD Observer at store window noted 68 comments on girl; 3 on tubes.

RTD takes a LOOK at LIFE



© Bachrach

SON & FATHER

G. Peabody Gardner, Jr., is newest member of G-E board of directors. Graduated Harvard 1910; lives in Boston; ex-Captain, Officers' Reserve Corps.; ex-Quartermaster, U. S. N. R.; ex-Ensign, Naval Auxiliary Reserve; ex-broker.



George Peabody Gardner, Sr., was senior member of G-E board of directors. Graduated Harvard 1877; lives in Boston; member of board since 1895 (that's 43 yrs.), has also been director of numerous other cos. throughout East.



MEETING. Tom Joyce (left) & Jack Williams, adv. mgr. of RCA Victor & popular record sales promotion specialist, respectively, dining in Waldorf-Astoria, where Benny Goodman, whose swing sells swell, is playing. They seem to like his rabid rhythms.



RETURN of McMurdo Silver (left) to radio kit & parts field wins congrats from Eddie Riedel, Raytheon Gen. Sales Mgr., & pres. of Western Div. of Sales Mgr's Club. Mac is now with Edwin I. Guthman & Co., & is pushing an improvement for shortwave work.



HEADS ENGINEERING STAFF

E. G. "PERK" PERKINS, for 3 yrs. on the engineering staff of Supreme Instruments Corp., has been appointed Chief Engineer. Park holds a B.S. in Electrical Engineering, and was member of many honor societies in college.



MANAGES SERVICE LABS

FRED J. WESSNER has become part owner & Gen. Mgr. of Radio Service Lab. of N. H., now operating in 3 states. Fred was formerly Gen. Sales Mgr. of National Union Radio, and until now, Sales Promotion Mgr. of Webster of Chicago.

The RSA Monthly Bugle

(News of the Radio Servicemen's Assn.)

Chicago (Ill.) Chapter held a meeting at which an engineer from Bendix Radio Corp. went into detail concerning the servicing & maintenance of modern airplane receivers. Neal Austin, Chairman of the Barter and Exchange Committee, is rapidly acquiring a knowledge of the numerous things that Servicemen want to get rid of. Lew Evans, Shops Standards Committee, went into the costs of doing radio servicing.

Decatur (Ill.) Chapter has launched an extended publicity and advertising program to acquaint the general public with the type of service done by RSA members. This is intended to counteract the ill effects of so-called radio mechanics who are daily fleecing the public. (And it's time the Servicemen were getting wise to this.—Editor)

The Washington, D.C., Chapter of the RSA has been established and formed under the direction of J. B. Austin, Jr., Chairman. Pat Hendrican, Sec., Bill Carrick, Treas.

Danville (Ill.) Chapter participated in the publicity and program attendant upon the opening of Station WDAN. The local charter of the chapter was presented by Joe Marty, Jr., Executive Secretary of RSA, at a recent meeting.

Staten Island (N.Y.) Chapter held its annual picnic recently and was host to 177 persons. There were so many prizes that a few had to be returned to the donors!

Minneapolis (Minn.) Chapter was host to over 150 Servicemen, including the RSA group from St. Paul. Chairman of the Minneap. group is Forrest A. Nelson.

All the efforts of the Green Bay (Wis.) Chapter were centered on a shindig to be held during the Christmas season for all members, and their wives and guests. A. J. Nejedlo was elected Chairman to make the necessary arrangements.

Fremont (Ohio) Chapter had the pleasure of hearing Mr. Scott of the Clough-Brengle Company give the complete story on Dynamic Testing for Radio Receivers, with a very interesting demonstration. (See article on this test system elsewhere in the issue.—Editor)

Annual banquet of the Buffalo (N.Y.) Chapter was a great success, as was the annual bowling party.

Combined meeting of all chapters in the 9th District of RSA was held in Pontiac, Mich. Fifty men representing the officers and executive heads of committees of all the chapters (Continued on page 508)

OFF THE PRESS

PEAK-BAND AMATEUR ANTENNA. CAT. NO. 165. Technical Appliance Corp., 17 E. 16 St., N.Y.C. Single sheet describing new "tuned doublet" for S.W. use.

INSTRUMENTS. PRICE SHEET NO. 49-I. Triplett Electrical Inst. Co., Bluffton, Ohio. 4 pp. Prices & descriptions, wide variety of meters.

RADIO TESTERS. PRICE SHEET NO. 49-T. Same co. 4 pp. Prices & descriptions, numerous testing devices.

RIDER MANUAL. VOL. IX. John F. Rider, 404 4th Ave., N.Y.C. 1650 pp. Includes 64 pp. on mechanical features of automatic tuning, etc., 140 pp. index, data on 1938-'9 receivers. Price \$10.

MAPS. General Electric Co., Schenectady, N.Y. Form GES-1996 is azimuthal world projection map centered on Schenectady; GES-1999 is same, but centered on Oakland, Calif. Both free to Hams.

1939 AMPLIFIER CATALOG. Amplifier Co. of America, 17 W. 20th St., N.Y.C. Complete specifications for 14 amplifiers, equalizers, mikes, speakers, etc. Free on request.

THROUGH SALES-COLORED GLASSES. Sales Talk Pubs., 148 W. 23rd St., N.Y.C. 16 pp. Inspirational dope for salesmen. 10 copies—\$3! (Continued on page 509)

AN EDITORIAL

By Artie Dee

The Chinese are a great people. But they are not as great as our ignorance of them.

However, there is one story about the Chinese which, whether true or not, is worth believing. **Darned Clever** It is so good it ought to be true—but probably isn't.

It isn't a funny story. It isn't even an exciting story. But it does contain a basic idea that, if put into effect, would not only clean up the radio business, but would put industry in general back on its feet.

Here, in a few words, is the story:—*Every year, on New Year's Day, the self-respecting Chinese pays up every cent he owes.*

Don't take it lightly; it's magic.

Perhaps Dr. Smith, and Butcher Brown, and Candlestick-Maker Jones owe you for service, or parts, or merchandise, and are letting their bills run on and on. . . . Therefore you cannot afford to pay Lawyer Robinson, and Grocer Green, and Merchant White. Which is why Robinson, Green and White cannot pay what they owe to Smith, Brown and Jones—and why Smith, Brown and Jones cannot pay you.

If we could but emulate those probably mythical Chinese and have a day for settling up—how much better business would be! We feel poor because we owe money; we feel short of cash because we cannot collect money due us. Therefore, we don't spend any more than we have to. And our customers, being in the same predicament, feel just the same as we do. This hurts our business.

That's the practical side of the story. Now look at the moral side.

Many of us do not value our financial integrity because it has no dollars-and-cents price tag on it. **Honor's Price Tag** remember, however, that financial honor is without a price not because it is valueless, but because it is invaluable.

Start the New Year by trying to get straightened out with your creditors. Your debtors will eventually do likewise.

Personal

WALTER SHERMAN MOODY, pioneer in transformer design, & in charge of this work for G-E from 1892 to 1927, when he became consulting engineer for the co. until 1931, died at his home in Pittsfield, Mass., at the age of 74. He was the first to apply silicon steel to transformer use.

G. PEABODY GARDNER, JR., has succeeded his father, GEORGE PEABODY
(Continued on page 510)

REPAIR DEPT. GIVES REAL SERVICE

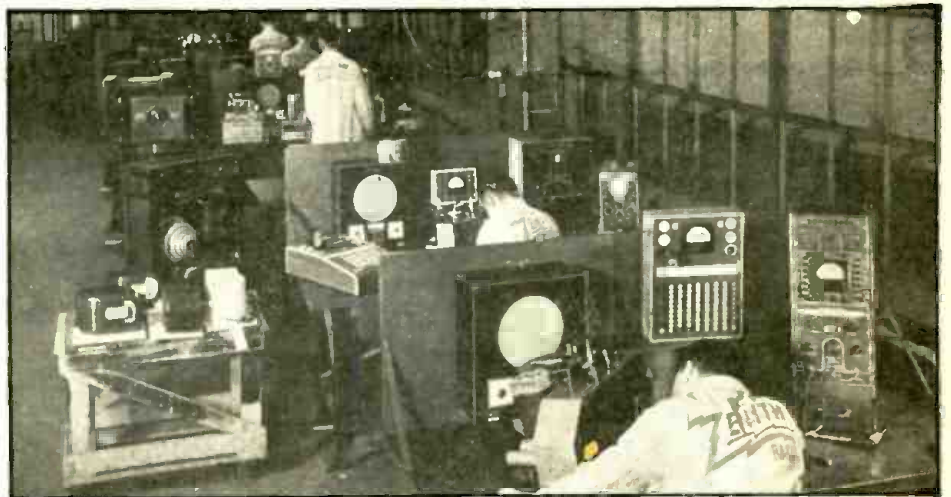

Ample space, personnel & equipment are afforded in repair dept. of Zenith, thus ensuring rapid, workman-like service, satisfied dealers & gratified customers. Note Supreme tube tester, oscilloscope & signal generator are in use by technicians in this well-equipped shop.



Natural Gas Pipeline Co. of Amer., in Chi., is hiring 3rd class radiotelephone operators without previous experience in radio. They've already hired 17 ops with 3rd class & 2 with 2nd class tickets.

Latest radio rag to fold is *Radio Stars*, a fan pub, and not to be confused with Ye Ed's tome, "Radio Stars of Today" . . . Climbing back to its feet is *Radio World*, which took a 10-count last Aug.; new bosses are in, but Herman Bernard, the meter mogul, still swings the blue pencil . . . Sparks-Withington (*Spartan*) have just got their FCC (Federal Communications Commission) license to commence *Finch* facsimile transmissions—& a subsidiary of I T & T (International Telephone & Telegraph Co.) has taken a facsy license under *Finch* patents . . .

Xmas gifts: What inventor opened box marked "Sweets to the

Sweet" and found it contained a cheap, low heel (purchased in 5-&-10)? . . . And how many people whom you know would such a description fit like a glove? . . . Federal Trade Commission alleges Johnson-Smith World-Wide All-Wave Receiver won't live up
(Continued on page 509)

NEW SALES SLANT



Something new in record catalogs is this British idea. It classifies records in divisions headed "Comic-Quaint", "Gay-Sparkling", "Peaceful-Serene", "Spiritual-Divine", "Pompous-Majestic", "Tragic-Gloomy", "Weird", etc. There's an idea worth stealing!

GOOD AS GOLD ON GOLD COAST

RCA tested a tropic radio cabinet by tossing it into the water above Niagara Falls & fishing it out (unharmd, of course) after it had gone over. Feat was celebrated by minting 75,000 gold-colored Lucky Coins, which were distributed here & there throughout the world.

Natives of Africa's Gold Coast took this funny money as seriously as U. S. radio listeners take an Orson Welles broadcast. Result was a letter to RCA from the Cie. Francaise de l'Afrique Occidentale, saying, "Lucky Coins—Our coast friends consider it inadvisable for you to send them this type of material since it results in the native population trying to pass these 'Coins' as gold pieces."

Maybe the natives aren't so dumb—they're passing the coins; not taking them!

MET TO DISCUSS DYNAMIC TESTING



Picture shows meeting of radio Servicemen conducted by Lukko Sales Corp., Chicago, for discussion of Dynamic Testing. Harold Justice, co.'s technician, was the chief speaker. He's one of the standees.

Changes & New Addresses

Ward Leonard announces that the territory of their radio representative, Charles D. Southern, 116 W. Rudisill Blvd., Fort Wayne, Ind., has been expanded to include Ohio, Ky., & Ind.

Amplifier Co. of America is now in larger quarters at 17 W. 20th St., N.Y.C.

Under the terms of a contract between Cornell-Dubilier Electric Corp. & International Standard Electric Corp., C-D's assistance on the production & sale of condensers has been made available to I.S.E. through the following affiliated mfg. cos.:

- Le Material Telephonique, 46 Quai de Boulogne, Boulogne-Billancourt (Seine), France.
- Bell Telephone Mfg. Co., Bubenberplatz 10, Berne, Switzerland.
- Standard Telephone und Radio A. G., Seestrasse 395, Zurich, Switzerland.
- Bell Telephone Mfg. Co., 4 Rue Boudewyns, Antwerp, Belgium.

BUCKS IN YOUR BELFRY?

Transformer Corp. of Amer., N.Y.C., has found a way of equipping churches with excellent & inexpensive "bells"—and helping Servicemen find dollars in empty belfries.

TCA's system employs a set of 21 chimes of the standard tubular type, such as musicians use. These are played from a small keyboard attached to the church's organ console. Their sound is picked up by 2 xtal mikes connected to a special 250-watt amplifier which feeds 4 horn-type speakers, each capable of handling 160 watts, placed in the belfry. Tried in a town with 10 sq. mi. area, the system has never had to be turned fully up.

Installation costs the church but a fraction of what it would pay for bells—and the sound can't be distinguished from that of a real carillon.

BIZ OPPS

There's business for those who will take the trouble to go after it. Here are 2 chances. Are they in your line?

Can you get this business? It's worth while!—Elwood M. Holleman, 102 Arthur Ave., Endicott, N. Y., writes:—

"I am interested in obtaining data and prices on carrier communication (wired-radio — Ed.) equipment, which must consist of several sending stations operating on different frequencies (possibly crystal-controlled), and 200 or more receiving stations capable of listening to any one of the several sending stations. All receiving stations would be for headphone operation and should be as compact as possible. A client of mine has a special use for this equipment."

F. Van Kerckvoorde, engineer of A.C.R., a Belgian radio mfg. co., 92 Rue de l'Ermitage, Bruxelles, Belgium, wants to buy a sample of "an excellent Vibrator 'B' Unit, on 6 V. battery, about 250 V., 75 ma., capable of supplying a shortwave super. without noise." He'll want more if the sample is satisfactory.

Sales Helps and Deals

A new baked enamel-on-metal flange sign with a hanging nameplate, for dealers & Servicemen, is offered by Hygrade Sylvania Corp., N.Y.C., to plug both the tubes & the dealer. Sign, 16 1/4 x 11 3/4 inches, is free; nameplate, 14 x 3 1/2 inches, is 25c blank, or \$1 with dealer's name in baked enamel.

Discounts ranging from 5% to 20% are given by NBC on supplementary networks when sold in conjunction with time on the complete basic Blue net.

Trade War With Dutch Over Argentine Market

New protests are being filed by RMA with Secretary Hull of the State Dept. & with the Dept. of Commerce against efforts of the Philips interests of Holland to secure special privileges in Argentina.

A preferential tariff on tube imports from Holland to Argentina is being sought by Philips & there is pending a reciprocal trade agreement between Argentina & Holland, reported to be sponsored by the Philips organization. Detailed information regarding the aims of the Philips concern is being furnished to the State and Commerce Departments by RMA together with pleas
(Continued on page 510)

\$'s & N^o. 's Dept.

RCA DOWN, when dividend for 3rd 1/4 of '38 was put at 6c a share, as compared to 8c of yr. ago. First 9 mo. of '37 brought stockholders 30c a share; of '38, 12c.

AND RCA UP, with an 87 1/2c divi-
(Continued on page 510)

Watch Out for April 30

The term "Ballast Tube" will be officially dead commencing April 30, 1939. It will be replaced by the words, "Plug-In Resistor".

Better Business Bureaus & the Federal Trade Commission had asked embarrassing questions about "ballast tubes" being considered in tube complements, so leading radio mfrs. decided to junk the phrase when advertising literature already printed has been used up. This, it is estimated, will occur well before the deadline set.

BRIEF BIOGRAPHY



HERMAN J. BERNARD is managing editor of *Radio World* for 14 yrs.; designed test equipment for mtrs.; wrote numerous tech. books, including 1st complete one on superhets.; is a grad. of St. Lawrence U. & a member of many learned societies. Now, having taken out several new patents, he has opened his own co. for mfg. a complete line of hi-quality, lo-price, test instruments.

SERVICING

QUESTIONS & ANSWERS

Servicemen may write, requesting answers to specific service questions. Address inquiries to Service Editor. For questions answered by mail, a service fee of 25c per question is made. Only questions of wide interest can be published.

LACKS SENSITIVITY

(106) Kenneth Stoll, Mount Pulaski, Ill.

(Q.) We have an Air-Mate model 544289 Pontiac radio set which does not operate very satisfactorily on an under-car aerial as supplied on the car, nor on a very short aerial in the shop. The stronger station comes in very suddenly when the set is tuned. Reception is distorted. This condition clears up when a ground or a good outside aerial is used.

We have tested a number of auto sets but none have acted just like this one. A new vibrator has been tried but it did not help. The set has been aligned which helped it a little. I have almost come to the conclusion this set is not sensitive enough because of the few tubes that are used.

(A.) We suggest replacement of the types 6F7 and 85 tubes. Should this procedure fail to overcome the condition described, check carefully the diode load and A.V.C. circuits. Check grid filter condensers for leakage and replace those which show leakage of 50 megohms or less.

INTERMITTENT NOISE

(107) Geo. Smith, Lebanon, Pa.

(Q.) I am having trouble with a Buick '38 Centerline radio set which breaks into a rasping noise after playing a while. I checked all condensers and all tubes, also the "B" voltage and everything seems to be OK. This noise is intermittent; it will be on for a while, then the set seems to "flop" and everything is OK again. I have checked the tuning condensers for shorted plates but they are OK, also. Please let me know if you have any suggestions as to this type of trouble.

(A.) From your description of trouble experienced with a "Buick" auto-radio set it would seem that the intermittent condition was caused by a loose or grounding antenna. This would be the most logical assumption if the rasping of which you complain were present when the automobile in which the receiver was installed was in motion. The fact that the noise is heard only after some period of operation, would lead us to suspect a faulty vibrator or a defective, loose-element tube. Check the voltage supply output with a voltmeter for some time to determine vibrator condition.

Diagnosing receiver troubles, as this department attempts, is difficult, especially where the information supplied is scanty. We shall better serve you in the future, where detailed symptoms are described.

SET "DEAD"

(108) C. H. Gaston, Bronx, N. Y.

(Q.) I have in my shop a Kolster 24 in which I have replaced the defective voltage divider. The set however would not play, so I placed a condenser, or at least touched the condenser to the plate and grid of the 210 output tube, and the set started playing, but with lots of crackling and distortion. When the set is turned off I again

have to do the same thing in order to make it play. I also find the type 26 tubes, 4 in all, are cold. Now what would you suggest could be the trouble?

(A.) It would seem that a close check of the input transformer to the 210 tube, in the Kolster model 24 receiver, is in order. Test the output transformer primary. Determine definitely the condition of the voltage divider once again.

You state that all four 26-type tubes are "cold." Should it be found, after test that these tubes are "good," then check the leads at the terminal strip between power amplifier and tuner chassis.

BACKGROUND NOISE

(109) Stephen T. Brock, Malden, Mass.

(Q.) I have a Bosch 670C on the bench for repair. This set has a continuous background noise which is heard on all bands. All voltages test OK, also all condensers and tubes seem to be all right (8 tubes).

I would appreciate some help on this set.

(A.) Analysis of the symptoms described points to defective I.F. transformer primaries. Check the D.C. resistance of these windings for a decided increase in value. Another method to determine the source of your trouble is that of shunting a low-range of a sensitive voltmeter across each primary winding, in turn, during operation. Any fluctuation noted on the voltmeter will disclose the faulty transformer.

INTERMITTENT CUT-OFF

(110) Harry A. Wagner, Jackson Heights, L. I.

(Q.) I have an Atwater Kent model 649 in for service. On the call, the customer said three different Servicemen tried to service the set in the last few months but failed to clear up the trouble. Complaint was that the set will play swell for about an hour, sometimes longer, then cut off and not play again. Sometimes it can be started the next day. Again it cannot be played for a few days, yet will play all of a sudden and stop within an hour or so.

I tested the tubes and found the 5Z4 rectifier very bad, showing no emission on 2 testers, I replaced the tube and supplied a new ground and antenna, and explained to the customer that the tube could be the trouble but from his story it was most likely something else. I advised him to try it out and call me back if the trouble occurred.

He called me in a few days and said the set had played all day, a couple days before (and much longer than usual), but finally cut off and could not be started again. I brought the set to the shop and gave it a complete check. Even changed the volume control, checked tubes again, especially the 5Z4, and all connections, voice coil, etc. I assured the customer I will finally clear it up and I don't want to admit defeat on this. I keep a file of all service notes published in your magazine but can find nothing on this. Can you suggest a lead?

(A.) On the Atwater Kent model 649 receiver, the most common causes for intermittent operation have been traced to open-circuiting 6F6 cathode bias resistors, open-circuiting coupling condensers to the volume control, and intermittent oscillator coil assemblies. The 6F6 cathode resistor is a flexible 250-ohm resistor. The audio coupling condenser is a 0.01-mf. unit. The oscillator coil may be removed, all leads checked at connecting lugs and resoldered.

In any event, the action of the shadow-graph should disclose which portion of the receiver is at fault when operation cuts off. Should the shadow operate normally when the receiver is tuned, then the trouble lies with the audio circuit.

OSCILLATION TROUBLE

(111) Barnett Mitchell, Selma, Ala.

(Q.) I have on hand a G.E. S-42 (RCA-R9) which is giving me some trouble by oscillation. Oscillation is bothersome on the high side of the B.C. band, occurring when each station is tuned in. Sensitivity is very bad on the high side also. The set operates very good on low side of the band. The 1,400 kc. oscillator adjustment doesn't seem to have any effect on the oscillation. I can tune through the oscillation and bring in a 1,500 kc. local, but other usually loud stations are very weak and interfered with by a whistle.

(A.) Oscillation and noisy reception on the G.E. S-42 receiver is usually caused by corroded rotor contacts of the tuning condenser gang. Remove the spaded rotor contacts, clean and reshape to secure improved tension, and then replace. For a permanent repair, secure a flexible pigtail lead between gang rotor and chassis.

There are 2 positions or settings where the oscillator trimmer may be adjusted. Adjust the oscillator shunt condenser (1,400 kc. trimmer) so that a 1,400-kc. signal is heard at 1,400 kc. on the dial with the trimmer at *minimum capacity* position.

NO CONTROL OF VOLUME

(112) L. Rojek, Lackawanna, N. Y.

(Q.) Here is a problem which has given me no end of grief. I have in my shop a "Bosch receiver," model 405, the tubes are 2A6, 57, 58, 47 and 80. The trouble is "no control of volume."

This radio receiver had a big hum when I got it. Replacing the 8 mf. filter condenser made the set play OK. Previous to this I disconnected the connections to the R.F. and I.F. coils which are in one can. I made a rough sketch of it and don't think I made a mistake in making the connections again. I tested the tubes, resistors and all the condensers and they tested OK. The voltages at the sockets tested OK. As a matter of fact I tested everything in the receiver and all tested OK. But still the volume control would not work. I tried a new one but with no results. Will you please tell me what to do?

(Continued on page 511)

RCA VICTOR HIGH-FIDELITY MODELS HF-2, HF-4, U-130

12-Tube Superheterodyne; 8-Station Electric Pushbutton Tuning; 5-Bands (540 kc. to 15.39 mc.); Shortwave Band-spread Tuning; A.V.C.; Phase-Inversion A.F. Amplifier; Undistorted Output 10 Watts; Aurally-Compensated Volume Control; "Triple-Cone" 12-in. Electrodynamic Speaker; Automatic Victrola (Model U-130 only); Temperature-Compensated Trimmers; Visual Tuning Indication; Noise-Reducing Control ("A" Band only).

(See Data Sheet No. 246 for Schematic Diagram, and No. 247 for Additional Information.)



RCA VICTOR Model U-130 combination high-fidelity receiver and automatic victrola.

ALIGNMENT PROCEDURE

Cathode-Ray Alignment is the preferable method. Connections for the oscilloscope are shown in the schematic diagram (see opposite page; Data Sheet No. 246).

Output Meter Alignment.—If this method is used, connect the meter across the voice coil, and turn the receiver volume control to maximum.

Test-Oscillator.—For all alignment operations, connect the low side of the test-oscillator to the receiver chassis, and keep the output as low as possible to avoid A.V.C. action.

Calibration Scale on Indicator-Drive-Cord Drum.—The tuning dial is fastened in the cabinet and cannot be used for reference during alignment, therefore a calibration scale is attached to the rear of the indicator-drive-cord drum which is mounted on the front shaft of the gang condenser. The setting of the gang condenser is read on this scale, which is calibrated in degrees. The correct setting of the gang in degrees, for each alignment frequency, is given in the alignment table, Fig. 2.

dial with 0-180 calibration scales drawn at top and bottom.

Pointer for Calibration Scale.—Improvise a pointer for the calibration scale by fastening a piece of wire to the gang-condenser frame, and bend the wire so that it points to the "0" mark on the calibration scale when the plates are fully meshed.

Dial-Indicator Adjustment. After fastening the chassis in the cabinet, attach the dial indicator to the drive cable with indicator at the 530 kc. mark, and gang condenser fully meshed. The indicator has a spring clip for attachment to the cable.

Spread-Band Alignment.—The most satisfactory method of aligning or checking the spread-band ranges is on actual reception of shortwave stations of known frequency, by adjusting the magnetite-core oscillator coil for each band so that these stations come in at the correct points on the dial.

In exceptional cases, when the set is being serviced in a location where the noise level is high enough to prevent reception of shortwave stations, a test-oscillator may be used for alignment, but an extremely high degree of accuracy is required in the frequency settings of the test-oscillator, as a slight error will produce considerable inaccuracy on the spread-band dials. The frequency settings of the test-oscillator may be checked by one or both of the following methods:

1. Determine the exact dial settings of the test-oscillator (for frequencies at or close to the specified alignment frequencies) by zero-beating the test-oscillator against shortwave stations of known frequency.
2. Use harmonics of the standard-broadcast range of a test-oscillator, first checking the frequency settings on this range by means of a crystal calibrator (RCA Stock No. 9572, for example), or by zero-beating against standard broadcast stations.

When a test-oscillator is employed for spread-band alignment, a final check should be made on actual reception of shortwave stations of known frequency, and the magnetite-core oscillator coil for each band should be re-adjusted so that the stations come in at the correct points on the dial.

Using RCA Stock No. 150 Test-Oscillator.—When using this oscillator for spread-band alignment, insert an open-circuit plug in the "EXT. MOD." jack, and set the test-oscillator dial 800 kc. lower than the desired frequency for the 4 lower frequency ranges, and 800 kc. higher than the desired frequency for the 2 high ranges. This provides an unmodulated signal of the desired frequency and the Magic Eye may be used as an output indicator for this unmodulated signal.

PRECAUTIONARY LEAD DRESS

- (1) Keep tuning tube cable and the lead from the left pilot light away from the 6F5 grid cap.
- (2) Leads on spread-band antenna and R-F coils and trimming condensers should be kept short as possible.
- (3) Keep black lead from L25 away from C38 and L21.
- (4) Keep black lead from L25 to cathode lug on 6J7 away from R17.
- (5) The power cord lead and the primary lead of the power transformer which connect to the power switch should be twisted together, and kept away from Volume Control.
- (6) Keep C13 away from the 6A8 control-grid lead and from the chassis.
- (7) Shielded leads to Victrola jack must be dressed away from switch terminals and jack.

(Text continued on Data Sheet 247, Schematic Diagram on Data Sheet 246.)

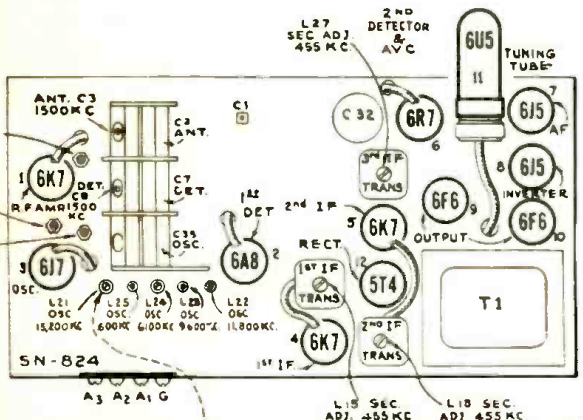

CAUTION: THIS ADJ. SCREW MUST PROJECT AT LEAST 3/4" FROM TOP OF CHASSIS TO PREVENT SHORTING +B.

Fig. 1. Locations of tubes and aligning trimmers.

Steps	Connect the high side of test-oscillator to—	Tune Test-Oscillator to—	Range Selector	Set Tuning Gang to—	Adjust the following for max. peak output
No. 1	Turn Fidelity Control to	Maximum Counter-clockwise position.			
No. 2	6K7 2nd I-F grid cap in series with .01 mfd.	455 kc.	"A"	Quiet Point between 550-750 kc.	L26, L27 (3rd I-F transformer)
No. 3	6K7 1st I-F grid cap in series with .01 mfd.	455 kc.	"A"	Quiet Point between 550-750 kc.	L17, L18 (2nd I-F transformer)
No. 4	6A8 1st-det. grid cap in series with .01 mfd.	455 kc.	"A"	550-750 kc.	L14, L15 (1st I-F transformer)
No. 5	A2, in series with 100 mmf. A3 to Chassis.	1,500 kc.	"A"	1,500 kc. (151.5')	C39 (osc.) C3 (ant.) C8 (det.)
No. 6	A2, in series with 100 mmf. A3 to Chassis.	600 kc.	"A"	600 kc. (30.0')	L25 (osc.)
No. 7	A2, in series with 100 mmf. A3 to Chassis.	1,500 kc.	"A"	1,500 kc. (151.5')	C39 (osc.)
No. 8	A2. Connect A1 to chassis.	6,100 kc.	"49M"	6,100 kc. (106')	L24 (osc.)*
No. 9	A2. Connect A1 to chassis.	9,800 kc.	"31M"	9,800 kc. (102')	L23 (osc.)** C4 (ant.) C10 (det.)
No. 10	A2. Connect A1 to chassis.	11,800 kc.	"25M"	11,800 kc. (90.0')	L22 (osc.)**
No. 11	A2. Connect A1 to chassis.	15,200 kc.	"19M"	15,200 kc. (78.0')	L21 (osc.)**

* Use maximum inductance peak (plunger in) if two peaks can be obtained.
** Use minimum inductance peak (plunger out) if two peaks can be obtained.
Note that oscillator tracks above signal frequency on all bands except "49M," where it tracks below.

Fig. 2. Alignment chart. Read text before using this chart, particularly "Precautionary Lead Dress."

RCA VICTOR
HIGH-FIDELITY
MODELS HF-2,
HF-4, U-130

(See Data Sheets No. 245 and No. 247 for Additional Information.)

Above — Connections and Colors of Loudspeaker Wiring.

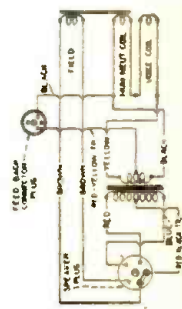

NOTE 1: CONNECT OSCILLOGRAPH "HI" TO THIS TERMINAL OF VOLUME CONTROL, "LO" TO CHASSIS.

— Universal Power Transformer Connections. (110-volt supply for a Victor Attachment may be obtained by connecting the motor to the red and the red-black leads.)

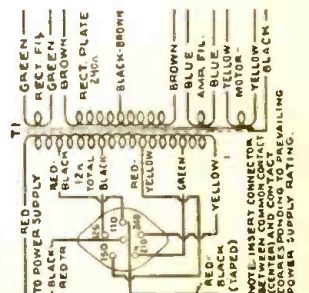

CATHODE CURRENTS

1	5.2 mA	7	0.88 mA
2	6.55 mA	8	0.88 mA
3	7.6 mA	9	26.8 mA
4	2.4 mA	10	25.0 mA
5	0.40 mA	11	109.2 mA
6	0.40 mA	12	109.2 mA

* TOTAL RECTIFIED CURRENT

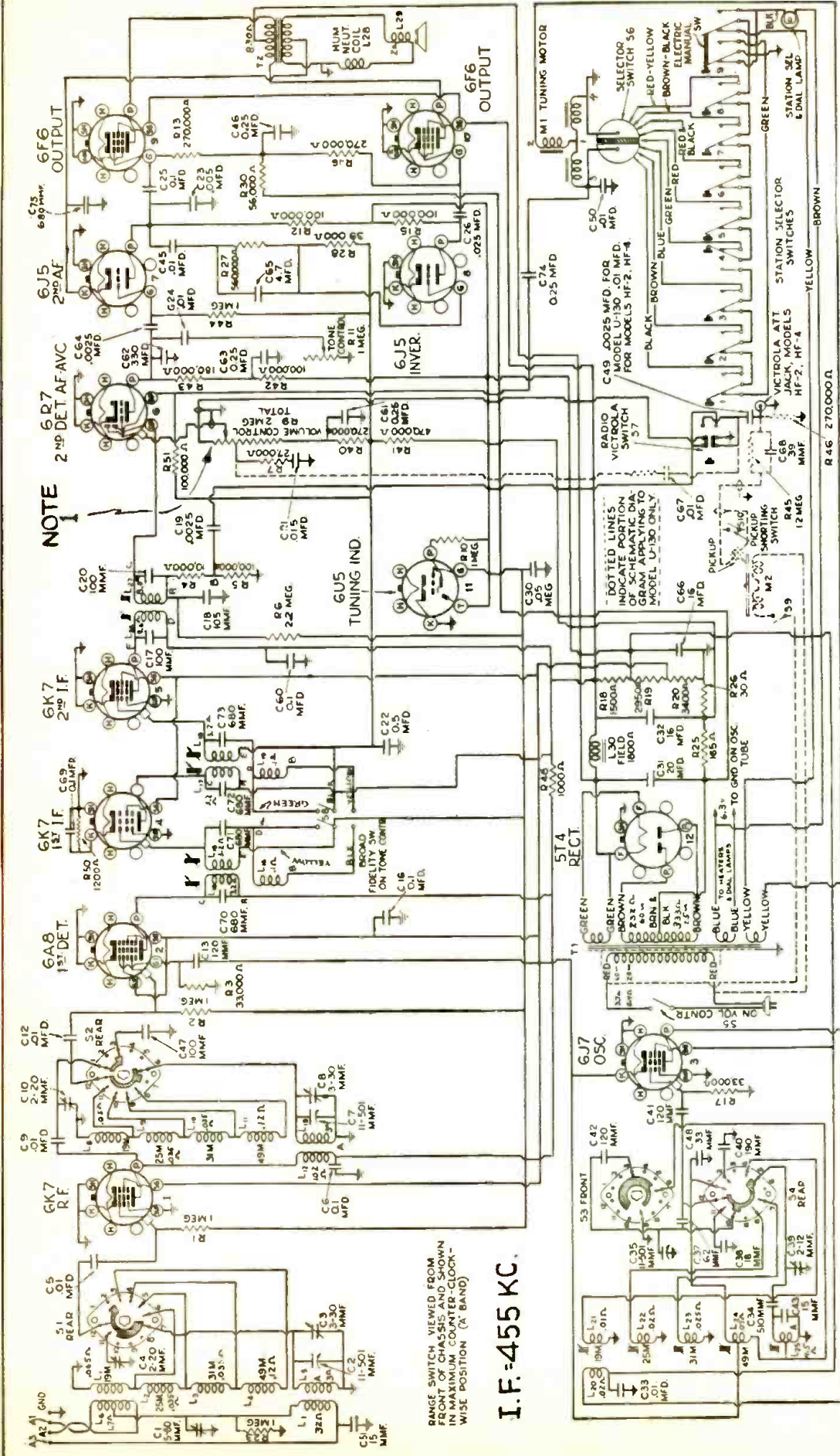

NOTE

RANGE SWITCH VIEWED FROM FRONT OF CHASSIS AND SHOWN IN MAXIMUM COUNTER-CLOCKWISE POSITION (A BAND)

I. F. = 455 KC.

THE RADIO MONTH IN REVIEW

(Continued from page 454)

MY FREE BOOK SHOWS HOW YOU CAN BECOME A MONEY-MAKING RADIO EXPERT!

YOU with my New **SPRAYBERRY Personalized HOME TRAINING in RADIO AND TELEVISION**

EASY TO START... EARN WHILE YOU LEARN

I Train You Quickly in Your Spare Hours ... Right at Home

You Do Practical Experiments with Real Equipment



I offer you a new and altogether different type of practical training for a money-making career in Radio and Television. I teach you in a simplified, logical, understandable style—all about Television, Electronics, Facsimile Radio, Radio Set Repair and Installation. I GIVE YOU PERSONAL COACHING ALL THE WAY.

TRAINING PREPARES YOU FOR GOOD RADIO JOBS . . . at Excellent Pay

No matter if you desire to BE YOUR OWN BOSS in your own business or hold down a good job in Radio, my Training will give you the useful information and knowledge to win success. DON'T JUST VISIT FOR MORE MONEY—START TRAINING FOR IT RIGHT NOW.

Read What This Graduate Says:
EARNED \$250 SINCE STARTING COURSE
 "I have only completed one-third of the Sprayberry Course and I find it very interesting, which makes it easy to learn."
 "By devoting several hours of my spare time daily to studying and servicing, I have made about \$250 since starting the Course." Earl W. Hostetter, R. No. 4, Lebanon, Pa.

YOU GET PROFESSIONAL TEST EQUIPMENT PLUS EXPERIMENTAL OUTFITS

Includes 146 RADIO PARTS for building a complete 5-tube Radio Receiver, RADIO TOOLS, ALL-WAVE, ALL-PURPOSE ANALYZER. Besides its invaluable use in experimental work, my Equipment will enable you to make spare time profits while you're learning and can serve you in your own service business later on. I give you DATA SHEETS on how to build popular radio circuits. Also, you receive BUSINESS BUILDERS which show you how to get and do spare time, neighborhood Radio Service work.



NO PREVIOUS EXPERIENCE NEEDED

My Training starts right at the beginning of Radio . . . covers all essential subjects. It makes no difference what your education has been, I can fit you for an excellent paying job in Radio. Your success is my full responsibility. I know how to get Radio across so that you will understand it . . . and remember it.

SERVICEMEN
 I offer Advanced Training for those already in Radio. Get complete details in my FREE 32-page Book.

REMEMBER THE SPRAYBERRY COURSE IS SOLD UNDER A MONEY-BACK AGREEMENT



RUSH THIS COUPON FREE for BIG FREE BOOK

DON'T DELAY! ACT NOW!

SPRAYBERRY ACADEMY OF RADIO
 F. L. Sprayberry, Pres.
 220-B University Place, N.W., Washington, D. C.

Please send me FREE copy of "HOW TO MAKE MONEY IN RADIO."

Name _____ AGE _____
 Address _____
 City _____ State _____

Tear off this coupon, mail in envelope or paste on penny postcard. Servicemen—Check here

MISCELLANEOUS (Continued)

doned hobby. Seven gave it up for lack of further interest in building sets, 2 for lack of time, 3 for loss of interest, and 3 because the hobby became their vocation.

The F.C.C. reported last month that it was too busy to pass on whether the types of auto alarms so far installed on certain ships meet with their approval. Tentative approval of these automatic SOS devices described as Radiomarine Corporation of America "Model AR-8600 Auto-Alarm" and "Mackay Radio and Telegraph Company Auto-Alarm Type 101-A manufactured by Federal Telegraph Company" is extended to March 31, 1939.

A total of 14 radio sets in the control tower at Chicago Municipal Airport went out of business last month when a power cable broke, darkening the air field for more than an hour, newspapers reported. Maloney and Decker on duty in the tower control room used radio sets in air liners on the field to contact incoming planes. (Is it possible an emergency power supply would have prevented the "blackout"?—Editor)

Variety's radio section, calls it *air-conditioned music* Paramount served up in "If I Were King." Sound engineers found recording best at 55 degrees constant relative humidity. The level was maintained by means of a humidity control machine brought onto the set for the purpose, according to the report last month.

The Federal Trade Commission last month made permanent a division for examining magazines and radio scripts as part of its work in detecting false and misleading advertising.

TELEVISION

N.B.C.'s *telemobile trucks* are really getting down to business at the World's Fair. Last month the ceremonies at the arrival of 1,000,000 tulip bulbs from the Netherlands for the Fair was televised. The air-line distance to the Empire State Building is 7½ miles.

Under the title "Television Future Still Obscure; See Theatre An Outlet," *Better Theatres* magazine last month discussed

many of the practical angles that concern the theatre's aspect of television. We quote one paragraph:

"The opinion that television, when it does arrive commercially, will come via the theatre, rather than the home, is . . . expressed in both television and theatre circles."

In making official announcement of Paramount Pictures' entry into the television field by assuming substantial interest in Allen B. Du Mont Laboratories (as previously reported in *Radio-Craft*), Stanton Griffiths, chairman of the Executive Committee, stated: "Television is bound to be a tremendous factor in entertainment. . . . Paramount recognizes its development in placing upon the motion picture industry a responsibility that is virtually an obligation to the public," according to the *New York Times* last month.

Allen B. du Mont's telepic station set-up is progressing. Call letters are W2XVT, operating in the 46-56 megacycle band. Video station's studios locus will be at the plant on Maine Avenue, Passaic, N. J. Plans are to start experimental operation on a regular schedule by Spring.

SHORTWAVES

The Third Division, U. S. Naval Communication Reserve, last month started a season of radio drills. Naval Reserve members who have attended at least 10 drills are entitled to substitute N for the W customarily used in their amateur call letters. The drills (handling of naval dispatches, etc.), are conducted by the Nassau County (N. Y.) ham group in the 80-meter band.

An emergency drill by radio amateurs in the Susquehanna Valley section was scheduled to go over the N.B.C. radio network last month via a control station at York, Pa. Program was arranged by the Susquehanna Emergency Network and included ham reports on river levels and messages from local Red Cross chapters contacted by the 16 participating amateur stations.

The Newark News Radio Club last month planned to utilize WOR's high-frequency transmitter, W2XJI, for transmitting 2 weekly broadcasts to its thousands of members overseas on a frequency of 26.3 megacycles.

The Pan American Peace Conference which opened at Lima, Peru, last month, utilized the speech translation system shown at right. While the speaker is talking an interpreter in each of the 4 languages—English, Spanish, Portuguese and French—translates into a microphone. Each delegate is supplied with an amplifier (wired to the mikes), earphones, and language-selecting and volume-control switches. One delegate's desk, so equipped is shown at A. The main amplifier to which the loudspeakers are wired is shown at B.

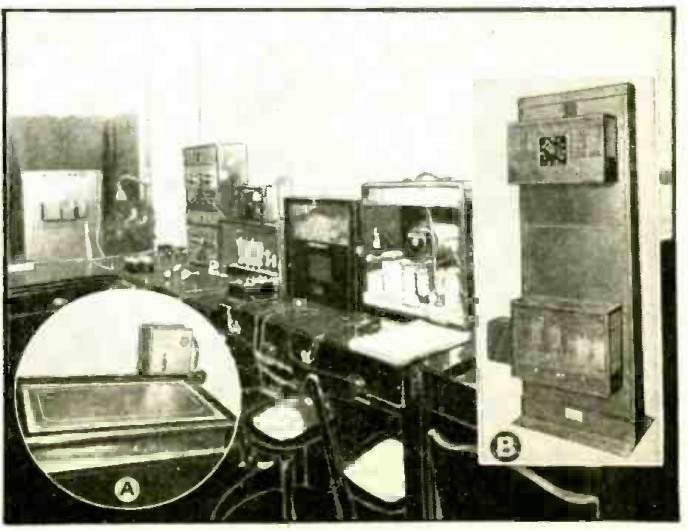

Photos and story—Int'l Tel. & Tel. Corp.

Please Say That You Saw It in RADIO-CRAFT

RCA VICTOR HIGH-FIDELITY MODELS HF-2, HF-4, U-130

12-Tube Superheterodyne; 8-Station Electric Pushbutton Tuning; 5-Bands (540 kc. to 15.39 mc.); Shortwave Band-spread Tuning; A.V.C.; Phase-Inversion A.F. Amplifier; Undistorted Output 10 Watts; Aurally-Compensated Volume Control; "Triple-Cone" 12-in. Electrodynamic Speaker; Automatic Victrola (Model U-130 only); Temperature-Compensated Trimmers; Visual Tuning Indication; Noise-Reducing Control ("A" Band only).

(See Data Sheet No. 246 for Schematic Diagram, and No. 245 for Additional Information.)

(Continued from Data Sheet No. 245)

- (8) Blue and black leads from antenna board to coils must be twisted.
- (9) Black lead and condenser which connect to 6F6 plate should be kept away from inverter grid lead and resistors which connect to it.

SETTING-UP THE STATION BUTTON

The left-hand pushbutton is a Victrola-Attachment switch. The right-hand pushbutton is for dial tuning.

- (1) Make a list of the desired 8 stations, arranged in order from low to high frequencies.
- (2) Turn range selector to "A" band, turn power on, and allow a few minutes for warming up.
- (3) Turn Fidelity Control maximum counter-clockwise.
- (4) Press down the "dial-tuning" (right-hand) button.
- (5) Manually tune-in in the first station on the list, using the Magic Eye for accurate tuning.
- (6) Hold down the "dial-tuning" button, and press down station button No. 1 (second from left). Both buttons will stay down, central dial lamp will light brightly or dully, depending on which side of disc the contact is. Move station-setting contact No. 1 to the insulating line on the disc at rear of gang. When the contact is correctly centered on the insulating line, the central dial lamp will go out.
- (7) Press down any other button in order to release the dial-tuning button and station button No. 1. Then press down station button No. 1 again. The electric tuning mechanism will function to tune in the station, and the central dial lamp will stay on.
- (8) Repeat this process for the remaining stations.

ELECTRIC TUNING MECHANISM

The circuit of the electric tuning mechanism is shown in the schematic diagram on Data Sheet No. 246. The action can be understood by following a cycle of operation:

When a station button is pushed in, it completes the 24-volt circuit through the corresponding station-setting contact and one-half of the brass selector disc, which is connected to one side of the motor field coil. This energizes the motor, and the rotor is pulled forward, engaging with the gear train that drives the tuning condenser and selector disc.

The condenser and disc then rotate until the insulation line comes under the particular station-setting contact, and the motor circuit

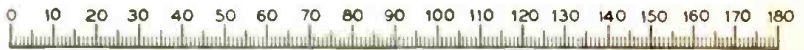
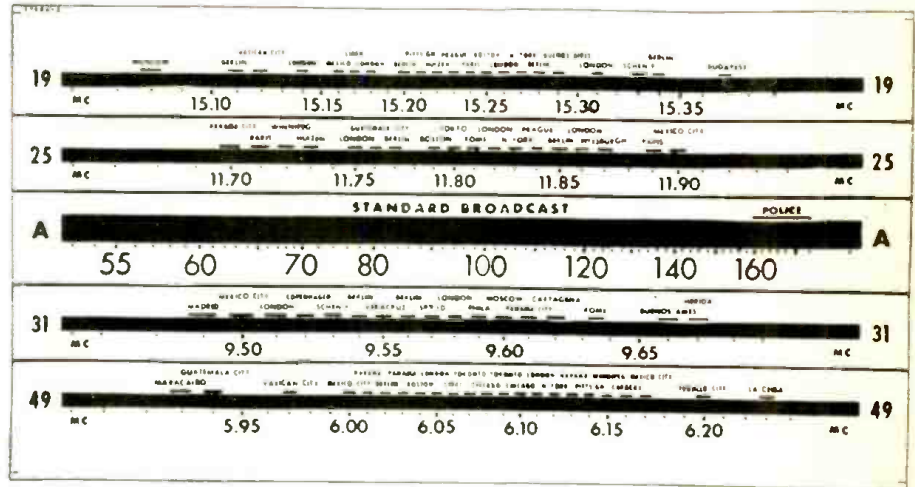
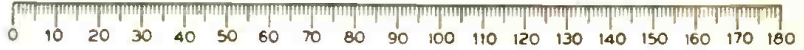

Fig. 3. Reduced Reproduction of the dial of Receiver Dial, and Corresponding 0-180° Calibration Scales. The corresponding position of the dial indicator for any setting of the calibration scale can be determined by drawing a line from this point on the bottom calibration scale to the same point on the top calibration scale. Read instructions under "Alignment Procedure," Data Sheet No. 245.

is broken. Inertia carries the insulation line past the station-setting contact which then makes contact to the other half of the disc. This completes the circuit to the other side of the motor field coil, causing the motor to reverse. The floating flywheel is still turning in the original direction and therefore slows down the reversal movement of the motor; as a result the selector disc is moved slowly back until the insulation line is under the station-setting contact, when the circuit is broken and the mechanism stops.

MUTING CIRCUIT

When the electric tuning mechanism is in action, the motor-supply voltage is fed into a diode rectifier circuit which applies a high bias to the 1.F. 1st audio and 2nd audio tubes. This prevents audio amplification and makes the set quiet or "mute" while the mechanism is operating.

ADJUSTMENT OF FLYWHEEL FRICTION

In normal operation, the motor drives the tuning condenser and selector disc until the insulation line just passes the particular

station-setting contact: The motor then reverses and moves the disc slowly in the opposite direction until the insulation line is under the contact, and the mechanism stops.

In some cases, particularly with high line-voltage, the disc may make 2 or 3 reversals before stopping.

The flywheel friction adjustment screw should be set to give the least number of reversals with the chassis in normal horizontal position.

ADJUSTMENT OF SELECTOR DISC

The brass selector disc is fastened to the rear shaft of the tuning condenser by means of 2 set-screws. When the condenser is at maximum (plates fully meshed) the insulation line should be horizontal, with the operating-end at the left (viewed from rear). The operating-end has dark insulating material and the brass is beveled at this end.

The selector disc should be set so that the contact-tip plungers in the station-setting contacts project not more than 1/16-in. from the body of the contacts.

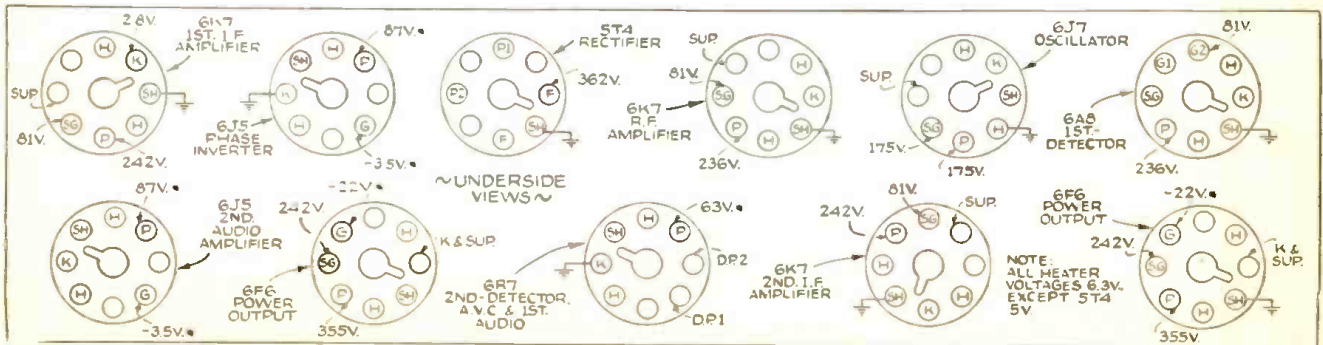

Fig. 4. Socket Voltages. Measurements made to chassis unless otherwise indicated, with set tuned to quiet point and volume control at minimum. Values should hold within approximately ±20% with 117-volt A.C. supply. *NOTE: Values with asterisk (*) are operating voltages in circuits with high series-resistance. The actual measured voltages will be lower, depending on the voltmeter loading.



It's Essential!

YOU'RE CAPABLE OF DOING BETTER SERVICE WORK

and you'll Do it — with **MODERN RADIO Servicing**

TEST EQUIPMENT
Theory and construction of every type of test and servicing equipment.

TROUBLE-SHOOTING
254 bases of latest short-cuts.

REPAIRING
Time-saving repair methods; superb alignment; instant force elimination; etc.

SPECIAL PROBLEMS
442 ranges on Auto-Radio; All-Wave sets; High-Fidelity sets; AVC and QAVC circuits; etc.

Don't be an "also-ran". Step out ahead with Ghirardi. Let him bring your radio service methods up to the minute—with methods that are in use today by leading servicing organizations. Let him teach you practical "tricks" of the trade, as well as fundamental theory. Let him show you how you can do your work better and quicker. Let him put some "juice" into your earning power!

It's got EVERYTHING!

Yes sir, with Ghirardi's great source-book behind you, you'll be equipped for any job that comes along. It gives you "the whole works"—every phase, every angle of modern radio servicing—clearly and concisely presented in Ghirardi's incomparable, easy-to-understand style, with hundreds of diagrams and photos. Get smart. Master-jot this great book today! **MONEY-BACK GUARANTEE!**

1300 PAGES 706 ILLUS.

\$4



RADIO & TECH. PUBL. CO., 45 Astor Pl., N.Y. Dept. RC-29
Here is \$4.95 (foreign) for my copy of "Modern Radio Servicing," with 10-day Money-Back Guarantee.
Here is \$6.50 (\$7 foreign), the "Special Combination Price" for the above book, together with "Radio Trouble-Shooter's Handbook" (see ad opposite).

NAME _____
ADDRESS _____
CITY _____ STATE _____
 Send free literature on MODERN RADIO SERVICING.



MIDWEST FACTORY SALE!



SAVE 50% NEW!

14-Tube WORLD WIDE CHASSIS IN YOUR CABINET

Only **\$19.95** COMPLETE WITH TUBES AND SPEAKER

30 DAYS TRIAL

140 TRADE-IN ALLOWANCE

on the beautiful 17-tube 5-band Model shown at left. Money-back guarantee. Write for new FREE 1939 catalog.

EASY TERMS **MIDWEST RADIO CORPORATION** Dept. 12-HH - Cincinnati, Ohio

COMPLETE STEP-BY-STEP DYNAMIC SERVICING

(Continued from page 469)

vibrator will be shortened and the insulation of both the transformer and condensers endangered.

What follows is especially important when a vibrator is replaced, for even though the replacement may bear the same number as the original, it may, in some instances, have a different reed frequency and different time efficiency. Both these factors will upset the balanced relationship which must exist between vibrator, transformer and buffers to insure long vibrator life.

Figures 3C, D, E, and F are patterns indicating operation with incorrect buffer condensers under various conditions.

Figure 3C is the type of pattern seen when operating a non-synchronous vibrator with buffers which are too large. Note that the slant portion of the trace is very short as compared with Fig. 3A. *Remedy:* Decrease the size of the buffers until the slant portion of the pattern is about 2/3 of the distance between the horizontal traces, as in Fig. 3A.

Figure 3D is a pattern resulting from operation of a non-synchronous vibrator with buffer condensers which are too small. The pattern formed by contact chatter is very similar in character to this (see Fig. 3H). If confusing, remove the rectifier tube and see if a pattern like Fig. 3E is obtained. If so, you are certain that the buffer condensers are too small. *Remedy:* Increase the size of the buffers until the pattern of Fig. 3A is obtained.

An open buffer condenser will be indicated by the patterns of Figs. 3D and E, exaggerated, of course, in characteristic.

Synchronous vibrators are best checked with the D.C. load removed from the filter. Be sure the filter load remains connected to the vibrator and secondary. Too large buffer condensers are then indicated by the pattern of Fig. 3C, and too small by the pattern of Fig. 3F. The oscillatory transient shown in this figure is entirely illustrative, and will vary with different types of vibrators and circuits. The presence of this transient rather than its shape is the important thing, indicating that the buffer condensers are too small. *Remedy:* Increase the size of the buffers until the pattern characteristics of Fig. 3A are obtained, with no D.C. load on the filter. Then connect the load and check the pattern of Fig. 3B.

OTHER DEFECTS

Figures 3G and 3H indicate 2 other defects that may exist in the vibrator circuit—*single-footing* and *contact chatter*.

Single-footing is caused by the reed making an incomplete swing in one direction, thereby shortening the time of contact closure and lowering the overall efficiency.

Additional buffer capacity will sometimes seem to cure this defect but should not be used, as the circuit conditions depicted by Fig. 3C will result, and the life of the unit will be short in any event. Replace the unit.

Contact chatter is not responsible for the amount of noise and other difficulty which is ordinarily attributed to it. It is important only when it indicates wear and needed replacement of the unit. In general, if the D.C. output of the power supply is steady and the pattern is steady, replacement will not be necessary.

This concludes Part II. Part III, the next instalment, discusses Receiver Alignment Procedure. Don't miss it!

This article has been prepared from data supplied by courtesy of Clough-Bregle Co.



It's Indispensable!

SPEED UP YOUR SERVICE WORK WITH THIS NEW DATA BOOK

It's always ready for Trouble!

RADIO Trouble-Shooter's HANDBOOK

Ghirardi's remarkable new servicing HANDBOOK is a fast worker—and a good one! In a flash it gives you the answers to the bulkiest receiver troubles. That "hard-to-find" job data is EASY to get—right between those two covers. There's nothing like it available anywhere! It gives you a huge mass of practical shop-tested information conveniently arranged, skillfully condensed, instantly ready for use, authoritative and up-to-date!

CASE HISTORIES

Trouble symptoms and remedies for 3,313 sets, compiled from actual service records. **J. F. PEAKS** Over 15,000 listings for alignment of all superhets, old and new.

GREATEST TIME-SAVER

Stop guessing! Quit huttering! Doubtful! Save worry! Use this great Ghirardi book and you'll speed up your service work, get better jobs and make more money. It's practical, thorough and thorough—just crammed full of short-cut service dope you can profit from every day in the week. **MONEY-BACK GUARANTEE** protects you. Send for your copy TODAY and use it!

AUTO-RADIO

Installation and Car Ignition Systems Data for all cars; Special Interference Elimination; Electrical Wiring Diagrams; Trouble Shooting Charts; Servicing Intercommunicators; Trade Directories; and over 30 other charts and tables.



New! OVER 500 pps. \$3

RADIO & TECH. PUBL. CO., 45 Astor Pl., N.Y. Dept. RC-29
Here is \$3 (\$3.50 foreign) for "Radio Trouble-Shooter's Handbook," with 10-day Money-Back Guarantee.
Here is \$6.50 (\$7 foreign), the "Special Combination Price" for the above book, together with "Modern Radio Servicing" (see ad opposite).

NAME _____
ADDRESS _____
CITY _____ STATE _____
 Send free literature describing the HANDBOOK.



ELECTRICALLY RECORDED RECORDS

SAVE MONEY ON ALL BRANDS OF PHONOGRAPH RECORDS

We have an exceptionally large variety of standard records (play both sides) played by popular artists. Records of hot dance numbers, vocal, waltzes, instrumental, old-timers, hill-billy, etc., are available. **WRITE TODAY FOR RECORD CATALOG.**

FREE GIANT RADIO CATALOG for Dealers, Service Men and Experimenters is NOW READY! Send postcard today for yours.

UNITED RADIO COMPANY Dept. R-1000, Newark, N. J.

RADIO ENGINEERING

RCA Institutes offer an intensive course of high standard embracing all phases of Radio and Television. Practical training with modern equipment at New York and Chicago schools. Also specialized courses and Home Study Courses under "No obligation" plan. Catalog Dept. RT-39.

RCA INSTITUTES, Inc.
A Radio Corporation of America Service
75 Varick St., New York 1154 Merchandise Mart, Chicago

KILLING THE "INTERMITTENT" BUG

(Continued from page 471)

will glow on as little as 5 volts, while they will all take as high as 14 volts safely. They are not only ridiculously cheap, but present a pleasing and professional appearance, and are readily mounted. Drill the mounting hole just large enough for bare clearance, insert the bulb, and snap a few turns of small rubber bands around it on each side of the panel. Allow the bulb to project through the panel about 1/2-inch. The socket is then supported by the bulb and the wiring. The rubber bands are inconspicuous, hold the bulb firmly, and obviate the necessity of an escutcheon, since they eventually semi-vulcanize into one solid mass. Thus the light forms its own jewel, bezel, and mounting bracket at a cost of 2 1/2c.

PROCEDURE

Procedure usually differs with the person, but I plug the set in No. 3 socket and check the drain, then return it to No. 1 for routine analysis unless the complaint is noise or "cutting off." In that case I give the set 10 or 15 minutes at about 130 volts to speed the warming-up process.

I also apply high voltage if the set appears to have nothing wrong with it when placed on the bench, for though some customers are imaginative they're not all crazy. I must point out that this brief overload of about 10 per cent will not damage GOOD parts, for the normal safety factor is several times greater. Those parts that are about to quit will pass out quietly and conveniently on the bench instead of 3 days later in the customer's home. If you are thinking of that fishy look you get when you tell a man there are 4 bad condensers in the set, just remember your reception on that call-back when you try to say "but this is a different trouble."

Dear Editor

(Continued from page 470)

indicator. The unit has retractable "patch-cord" test and antenna leads, eye-level indicators, and several assorted "short-cut" circuits such as the one I enclose. (Figs. 1 and 2 in the article printed here.—Editor) Speedy analysis and repair result from complete, accurate, and accessible equipment, and convenient and comfortable working conditions.

During the past year I have enjoyed the unanimous praise of both layman and technician. I feel that others may be interested. If your publication is of the same opinion I shall be glad to submit an article or series of articles, together with photographs, design data, circuits, working constructional drawings, and arguments for the trend. That it is a trend is evinced by the feelers extended by several instrument companies in past months. My unit is several steps ahead.

Thank you for your consideration.

Yours respectfully,

HARL O. PIETY

Hollywood Turns to Radio!

Read how Radio is increasingly influencing the production of motion pictures in the March Issue

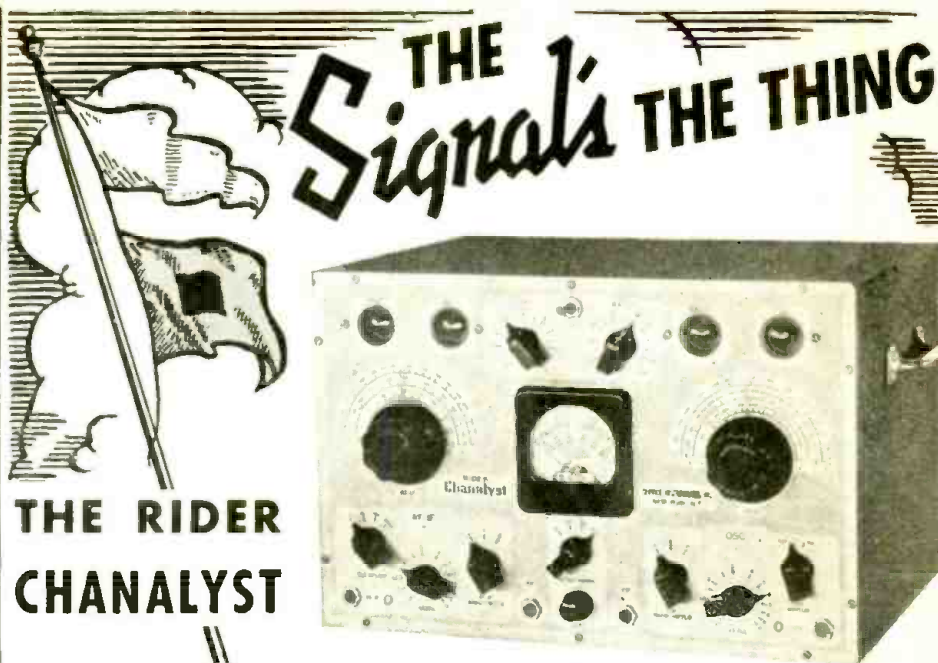

THE RIDER CHANALYST

THE MOST Fundamental METHOD OF TROUBLE-SHOOTING

THE SIGNAL'S the thing in which the customer is interested. the signal's the thing which you must restore to normalcy. the signal's the thing you should check before applying any other test or series of tests. This because the signal is Fundamental. With the Rider Chanalyst you follow the signal right through the set (from antenna to loudspeaker) as fast as you can move a probe from point to point. Thus you quickly localize the trouble and eliminate guesswork as to its source. The Rider Chanalyst has been proved by competent servicemen in all parts of the country who have sent us testimonials on its time-saving efficiency. But—don't take someone else's word for it—see for yourself—get a demonstration of this sensational trouble-shooting instrument from your jobber.

"There's Only ONE Rider Chanalyst. Compare it with ANY other instrument."

Professor Probe Says:
**"ALL TROUBLES
 IN R-F AND I-F SYSTEMS
 ARE NOT MISALIGNMENT"**

"Many of the defects which influence the signal are to be found in r-f and i-f systems. The signal voltages in antenna, r-f, i-f and mixer circuits may vary from a few microvolts to as high as 50,000 or 75,000 microvolts. The Rider Chanalyst is the ONLY instrument which can be used in r-f and i-f systems to measure very simply such signal voltages during the process of amplification, rectification and frequency conversion—to most rapidly localize any defect.

"In addition, the Chanalyst provides means for measuring control action in avc, afc and discriminator systems—a-f signals—and for localizing the cause of hum, distortion or intermittents. And this it does without interfering with the normal operation of the set.

"Next month I'll give other examples to demonstrate that in radio trouble-shooting—'The Signal's the Thing.'"

JOHN F. RIDER



The RIDER Chanalyst

SERVICE INSTRUMENTS, INC., 404 FOURTH AVE., NEW YORK CITY

Please Say That You Saw It in RADIO-CRAFT



Do yourself a good turn . . . and let that good old scout "Old Man Centralab" help you with his ADASHAFT Kit . . . housed in a swell metal box, hinged, contains ten Midget Radiohms, five types of attachable shafts, etc. This kit will enable you to do some mighty fine "deeds" for more than 400 different makes of receivers . . . actually thousands of different models. See your jobber.



MIDGET RADIOHM ADASHAFT KIT

Centralab
MILWAUKEE WISCONSIN

DATAPRINTS

TESLA-ODDIN HI-FREQ. COILS
20c Ea. in order for 10 (Data and Drawings only.)
36" Sp'k Tesla-Oudin Coil 40c (1 K.W. Exc. Trf. Data, included FREE!)
8" Sp'k Tesla-Oudin Coil 40c (1/2 K.W. Exc. Trf. Data, included FREE!)
3" Sp'k Oudin; 110 Vt. "Kick Coil" type40c
3" Sp'k Tesla Works on Ford Sp'k Coil40c
1" Sp'k Violetta Hi-Freq. Coil40c
FREE with order \$1.00 or more—20 Tricks with Hi-Freq. Coils (40c separate)

20 ELECTRIC PARTY AND LODGETRICKS!
Loads of Fun!
How to Shock 'em!40c
Order with other prints.
See special price below and save.

SOLENOID AND MAGNET DATA
Get Our List!

20 Telephone Hook-Ups—Build your Own 40c

YOU need these DATAPRINTS!

Electric Pipe Thawer	Welding Transformer, 2 K.W.
100 Mechanical Movements	Rewinding Armatures
20 Motor Hook-ups	Einthoven String
Resistance Measuring Bridge	Galvanometer
	20 Simple Bell Circuits

Special Prices:
4 prints \$1.00; 10 for \$2.00;
40c each, single orders.

The DATAPRINT Co.
Lock Box 322B, Ramsey, N. J.

THIS HOME—WIRED FOR RADIO

(Continued from page 461)

Therefore in squaring the frames around the speaker brackets we must make certain that the 2" x 4" pieces used are placed with their 4" side facing front. This provides a 2-in. clearance to the back of the wall; maintaining a clear air column.

To absorb the back wave it is necessary to line the air column in which the speaker is to be mounted with some sound-absorbing material such as acousti celotex or rock wool. This material should be at least 1/2-in. thick.

ARMCHAIR CONTROL OUTLETS

In certain of the rooms it may be desirable to have armchair controls so that when comfortably seated in front of the fireplace, for instance, or at the dining-room table, it will not be necessary to go to the wall to tune-in stations. For this purpose therefore it is necessary to have one or more outlets in these rooms so that the portable armchair control need only be plugged into them. Three of these outlets are shown in the floor plan diagram printed in Part I. Their location in other homes will depend entirely upon the individual preferences of the prospective home owner.

Figure D shows the preliminary wiring for one of these outlets. It consists merely of a standard electricians' Gem box into which the wiring cables are run. The outlet itself, a Yaxley 22-contact "convenience outlet," is also shown in the illustration. The actual wiring of these outlets as well as that of the speakers and other remote units will be given in other installments.

RUNNING THE CABLES

The system calls for a 15-wire cable but since we could not readily obtain such a cable we used two 7-wire Birnbach cables, each with a shielding jacket which we will later tie together and utilize as the 15th wire (which is at ground potential anyway).

Figure 3 shows just how to run the cables. Keep them short and try to run as many as possible beneath the floorboards among the beams so that if the wiring plan later on becomes lost, the Serviceman will have the least possible trouble tracing the cables. In the diagram, the cables shown dotted run below the floor, all others run inside the walls. Leave about 18 ins. of cable protruding from each speaker niche so that after all connections are made, the

bracket can be freely swung open on its hinges. For the armchair-control outlets 6 ins. will be enough.

Make no connections to any of the apparatus yet. This will be done after the entire house is completed, and will be discussed and illustrated with detailed schematics in a subsequent installment.

WIRING FOR THE "TELECHIMES"

While we're at the stage of preliminary wiring, we might as well run the necessary wires and cables for the "TELECHIME" Paging System. Refer to Fig. 4. The panel mechanism will probably be placed in the cellar, on the same board with the house lighting meter and fuse block. From this point therefore, run the following wires:

- (1) A 5-wire cable to the "TELECHIME" niche in the vestibule.
- (2) A 5-wire cable to the keyboard outlet in the dinette. (See Part I for a discussion of the "TELECHIME" Paging System.)

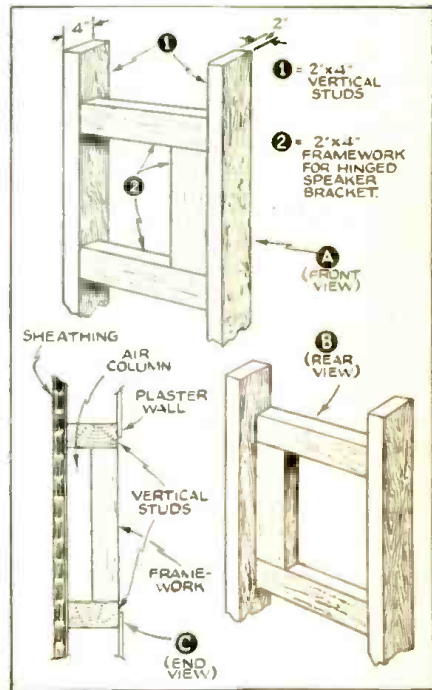

Fig. 2. Details for "squaring off" the speaker brackets. Note that whereas the vertical studs are 4" deep, the framework is only 2" deep, thus providing a 2" clearance for the air column.

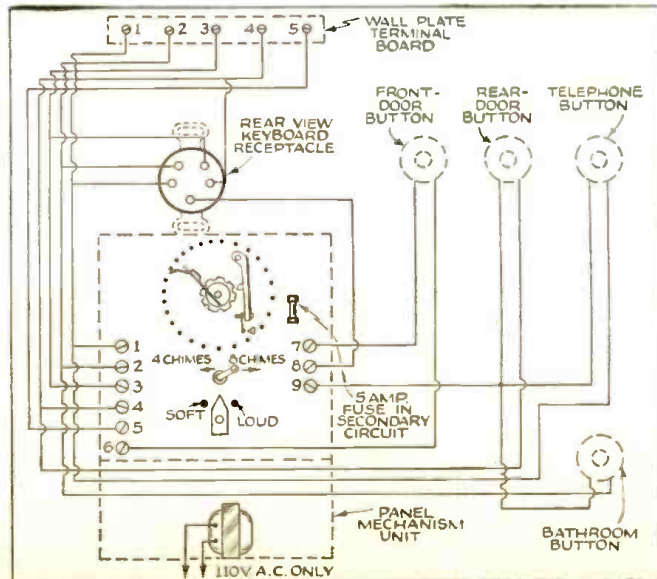

Fig. 4. Wiring diagram for the "TELECHIMES." The step-down transformer in this system replaces the ordinary bell-ringing transformer. Further, since this transformer will always be across the line, it will be used to energize the "On-Off" relay for the built-in radio system.

- (3) Two wires to the front-door button.
- (4) Two wires to the rear-door button.
- (5) Two wires to the button near the telephone.
- (6) Two wires to the safety button in the bathroom over the tub.

This completes the preliminary wiring for the "TELECHIMES."

All cables for the entire built-in radio system are now in place as are all the remote speaker brackets. Before we can proceed with the actual wiring of all units we must wait until the interior of the home is completely finished. However, in the next installment we can go ahead with the necessary preparations for adapting the master receiver to the radio system, which in itself is quite a time-consuming task.

Caution: For the purpose of illustration Fig. C shows one of the speaker brackets completely mounted with all its components. Do not actually mount any of the equipment on the wooden brackets until you are ready to wire them, for they may be damaged by the carpenters, plasterers or others of the swarm of workmen busy on the house.

List of Parts

- 1—RCA Victor model U-130 high-fidelity radio and phonograph combination;
- 8—Mallory-Yaxley multiple pushbutton switches, type 2168 (7 for remote tuning and 1 for use in the armchair control);
- 7—Mallory-Yaxley 500-ohm "T"-pads, type T-500;
- 7—RCA permanent-magnet dynamic speakers, model MI-6248-A;
- 7—Mallory-Yaxley pilot light brackets, type B-310 (bayonet socket);
- 7—Mallory-Yaxley 6.3-V. dial light bulbs, type 172 (bayonet bases);
- 3—Mallory-Yaxley multiple connection plug outlets, type 122;
- 1—Mallory-Yaxley single-gang outlet for antenna and ground, and A.C. power connections, type 133;
- 1—RCA autotransformer for matching output of master receiver to the remote speakers, type MI-4603;
- 1—6.3-V. transformer for the remote dial lights;
- Birnbach Radio Co. 250 ft. of 7-conductor shielded cable, color coded, type 977;
- 1—RCA "On-Off" remote-control 24-V. relay;

MISCELLANEOUS

(The following items are not part of the radio installation but are interesting and allied developments worthy of incorporation into the "Radio Home.")

- Model 446 Aristocrat "TELECHIMES" by General Kontrolar Company, Inc.;
- 6—General Electric single-pole mercury-contact toggle switches, type GE-3088, with plates;
- 6—General Electric 3-way mercury-contact switches, type GE-3091, with plates.

CLARENCE H. MACKAY DIES

Last month Clarence H. Mackay, chairman of the board of the Postal Telegraph & Cable Corp., died in his town house in New York. Postal Telegraph cables, running two-thirds of the distance around the world, were silenced for 1 minute.

Also silenced for 1 minute was the worldwide radiotelegraph network of Mackay Radio & Telegraph Co. (Calif.), and Mackay Radio & Telegraph Co. (Del.). Mr. Mackay was director of both companies and chairman of the former; both companies are subsidiaries of P.T.&C.C., and maintain radiotelegraph service to 16 key cities in the United States.

"I CAN TELL YOU IT'S RADIO'S GREATEST BOOK!"

EVERYTHING IN RADIO
ALLIED RADIO

"and thousands of radio Dealers, Servicemen, Amateurs, Sound Men and Experimenters agree!"

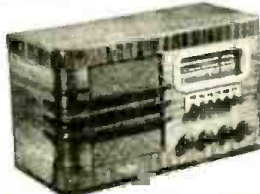

NEW SETS

• Sensational new values—62 new models—as low as \$6.95—advanced features! New "Tiny Knights," 1.4 V. battery sets, sets for AC, AC-DC, 32 Volt, 6 Volt and auto operation. Models from 4 to 16 tubes—all backed by Radio's strongest guarantee! Also, latest phono-radio combinations, phonographs, record players, etc.—all priced exceptionally low to bring you greater savings and bigger profits!



NEW P. A.

• Revolutionary new Knight Sound Systems, from 8 to 65 watts, in standard and deluxe models. New 30 watt mobile job (see illustration), Electric Guitar Amplifier, Booster Power Stage, etc. Also, the most complete line of recording equipment in any radio catalog!

"180 pages of real values like I've never seen before—all in ALLIED's free 1939 Radio Catalog!"

- You never saw a radio book as complete as this ALLIED Catalog. It shows you Everything in Radio—at prices that'll really open your eyes! You'll save hours of time and trouble—and plenty of money—with ALLIED's 1939 Catalog! That's what Everyone in Radio is saying, because the ALLIED Catalog is packed with over 14,000 radio items—all at the lowest prices, because ALLIED is the 100% Radio House.
- Selling radio exclusively, serving the radio world quickly, efficiently, economically. Send for ALLIED's Catalog today—it's not only Radio's Greatest Book—it's the Buying Guide for thousands of wise, value-minded radio men!



New! KITS... HAM GEAR... TESTERS

Radio's largest selection—Beginners' Kits, Photo Cell Kit, Electric Fence Control—100 diagrams and projects! Free Parts Lists.

Giant Ham Section—newest Hallcrafters, National, Hammarlund, Howard, Thordarson, Utah, G.T.C., Sargent equipment!

All leading lines of tube checkers, set tester, analyzers, oscilloscopes—Elder, Supreme, Triplett, Readrite, etc.



IT'S A FACT! In 1938 ALLIED answered over 100,000 letters asking for advice and information—quickly, accurately, personally. That's about 20 million words, enough to fill 80 standard size volumes.—And we're prepared to answer more in 1939!

ALLIED Radio CORPORATION

Send for **FREE Catalog!**

ALLIED Radio Corporation
Dept. 2-B-9
833 W. Jackson Blvd., Chicago, Ill.
Send me your 1939 Radio Catalog.

Name

Address

City State

Be a RADIO EXPERT—Learn AT HOME

RADIO SPECIALISTS NEEDED

Modern receivers with their complicated circuit systems have knocked out the old time cut-and-try radio fixer. Trained men with up-to-the-minute knowledge are needed to service these new sets.

HERE IS YOUR OPPORTUNITY

Your possibilities of making money and getting ahead are limited only by your ability and skill—but you must know more than the other fellow. You must be a radio service specialist, as R.T.A. can train you.

PRACTICAL TRAINING AT HOME

Our home study course is practical "shop and bench" training combined with a thorough set of practical lessons prepared by an experienced Radio service engineer. Four working outfits are also furnished.

MAKE SPARE TIME MONEY

Our training is complete and practical. We show you how to make money almost from the start. The course can easily be made to pay its own way. Investigate now, write for free book of details.

WHAT R.T.A. STUDENTS SAY

Norwood, Ohio
I have connected with a large firm as Radio Service Manager and wish to extend my thanks for your help.
Joseph Radien, Jr.

Yorkville, Ohio
From Aug. 1 to Dec. 7, 1936, I repaired 163 radios and put up 43 aerials which is very good for part time work while studying your course.
Chas. Koerber.



FREE OF EXTRA COST

To start you making money without delay we equip you with this Circuit Analyzer and Point to Point Resistance Tester.

RADIO TRAINING ASS'N OF AMERICA
Dept RC-29, 4525 RAVENSWOOD AVE., CHICAGO

Please Say That You Saw It in RADIO-CRAFT

UNIQUE SOUND EFFECTS

(Continued from page 457)

after drinking from the bottle the White Rabbit had left on the table outside the Garden.

They put Alice in a gobo, a sound effects screen with one "live" and one dead side. Alice stood on the alive side and talked in a very little voice. Then, as she grew, her voice was fed through an echo chamber, which is a long, acoustical labyrinth adding reverberation to the voice.

A simple, yet somewhat effective echo effect can be produced by placing a dynamic microphone, face down, in the hole of a grand piano sounding board. With the top of the piano half-open and the dampening pedal held down so as to leave the strings free, voice or sound effects are directed into the open piano. The strings of the piano start to vibrate and give a microphone pick-up that simulates an echo. This has been effectively used on such a program as "Renfrew of the Mounted."

The Sound Effects department is never free from the possibility of emergencies. One night, during a "Gangbusters" broadcast, sound effects engineer Ray Kramer suddenly discovered that the hose through which he meant to blow bubbles in a tank of water to represent a drowning man, was missing. The cue was coming up. There was nothing for Kramer to do but start to drown himself. He ducked his face half into the tank and blew his own bubbles the way nature would have done if she'd been consulted. (The tank is a metal one, with a canvas lining to prevent picking up the sound of water slapping against the sides. Kramer removed the device, which when turned, gave the effect of lapping water.)

One of the most amusing sound effects—it got a good chuckle out of Pierson himself—was the one Max Uhlig used to milk a cow over the air. He used 2 ear syringe bulbs filled with water and a big bucket. It was perfect.

Leaving this network, let's see what's new in sound effects on a competitive net.

N.B.C. The increasingly high fidelity output of

broadcast receivers and proportionately improved frequency response of the receivers themselves have made it not only possible but necessary that sound effects be altered to suit the trend.

Thus we find that shots are no longer produced by whacking a stick across a carton or the padded seat of a chair. Instead, real .22 or .38 pistols are used at the National Broadcasting Co.

Before the department was established, the sound of a closing door was made by dropping the lid of a studio piano, but now there are 25 real doors, in portable frames, that supply the door-closing wants of broadcasting in Radio City. Door-closing and bell-ringing are the commonest sound effects used.

For several years salt poured over crisp lettuce leaves was the standard sound effect for rain. The rain machine in use today at N.B.C. headquarters, however, is a complex machine that now produces the sounds of 5 different degrees of rainfall. The secret to the faithful sound is the controlled sprinkling of birdseed upon gauze impregnated with cellophane and stretched taut in a frame, and upon 4 other surfaces each of which produces a sound of slightly higher frequency.

Cellophane, incidentally, is a versatile mimic itself. Crumpled properly in the skilled hands of the N.B.C. sound technicians, it sends through the microphone the sounds of frying eggs, burning wood, the snapping of dry twigs as they are trampled upon.

The sound of swishing water made in the Show Boat broadcast and others requiring such "scenery" is nothing more than a miniature reproduction of a steamboat stern-wheel turned by a crank in a tub of water. A rocking tub of water makes a noise like waves, and common household brushes make a perfect imitation of the wash of surf.

The chief technician was asked one day to make a noise like 2 men crashing through underbrush. He picked up a whisk-broom

SPRAGUE 450 VOLTS

HOW GOOD IS A MIDGET CONDENSER?

The answer is they're better than you ever thought midget condensers could possibly be—that is, if you specify Sprague ATOMS. These tiny dry electrolytics are made by an exclusive Sprague etched foil process. They are smaller, better and unconditionally guaranteed against blow-ups. Low leakage, actively prevents over-heating. Build-up is amazingly quick. They'll stand higher voltage surges than most large condensers. In short, ATOMS are unexcelled for universal use—just the thing to save money and still get real Sprague quality. DUAL COMBINATIONS as well as singles.

Here's Where You SAVE REAL MONEY

Shown here is a typical ATOM value—an 8-8 mfd. 450 V. unit only 1" x 2 3/4", listing at \$1.00. A single section 8 mfd. 450 V. ATOM lists at only 60c. Think of the money you save!



SPRAGUE PRODUCTS CO., North Adams, Mass.

SPRAGUE ATOMS "Mightiest Midgets of All"

EXTRA BARGAIN BULLETIN BIG MONEY SAVING CATALOG Just off the press

JUST A FEW OF 500 ITEMS AT NEW LOW PRICES

New 1939 Camden 5 Tube RADIO-PHONE COMBINATION

Superb performance. Polite calls and broadcast pickup. Plays up to 12" records. Dynamic Speaker. Walnut finish. Each \$16.95. Lots 3 net each with tubes



ELGIN ELECTRIC RAZOR

Sensational Value! Quick, clean shaves without brush, blades or lather. No cuts. No irritation. AC. Net each



AIRMASTER 1939 5 TUBE AC-DC RADIO

Biggest "Little Radio" Value. Amazing volume, superb tone. Illuminated airplane dial. Dynamic speaker. Range 540-1750 KC. In rich walnut cabinet. \$6.95 with tubes



RADIO CIRCULAR CO.

915 Broadway, New York, N. Y. Rush Free Copy of BARGAIN BULLETIN. No obligation.

Name
Address
City State

MAIL THIS COUPON FOR FREE CATALOG

RADIO COURSES

New Classes Now Starting
RADIO OPERATING—BROADCASTING

- RADIO SERVICING—a practical course
- RADIO AMATEUR CODE ● TELEVISION
- ELECTRONICS—1 yr. day course 2 yrs. eve. Day and Evening Classes. Booklet Upon Request.

New York Y. M. C. A. Schools
4 W. 64th Street New York City

ECHOS WHILE YOU WAIT!

Echos as you want them—long or short, loud or soft—are now available upon request. The "echo chamber" does the trick. Sound projected into a short, medium or long room—cement-and-linoleum lined—bounces around and around, until it finally reaches a microphone at the far end as a short, medium or long echo, respectively, at N.B.C.

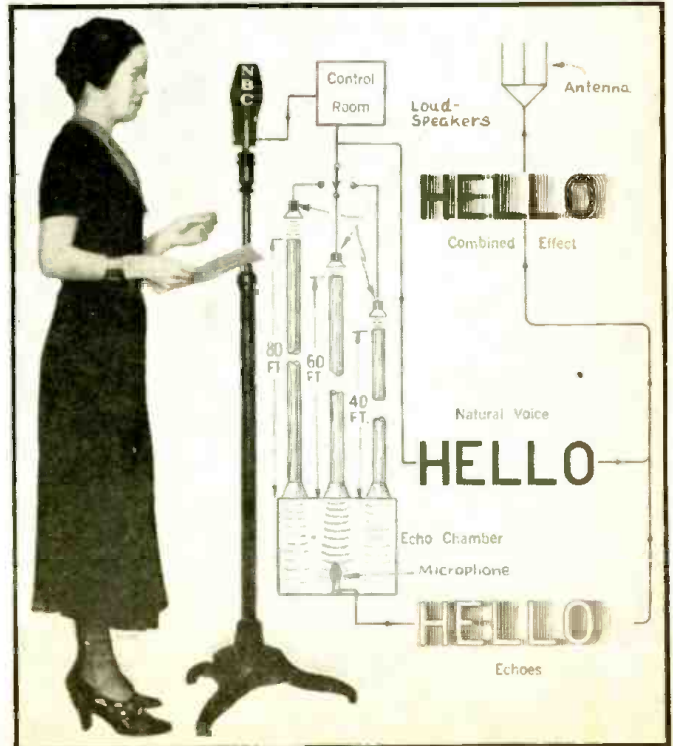

Please Say That You Saw It in RADIO-CRAFT

experimentally and crushed it in his hands. It did the trick.

Scores of new streamlined sound effects have been installed in Hollywood Radio City (California) as part of the expansion which followed the opening of the new National Broadcasting studios.

Most impressive of the many gadgets added to the N.B.C. sound effects department's inventory is a gigantic thunder drum, whose notes will soon be heard in dramatic programs from Hollywood. More than 6 feet square in its finished form, the thunder drum was manufactured from a steer hide that measured 7 feet square. The unique sound effects drum was manufactured in New York to specifications drawn by Harry Saz, chief of N.B.C.'s sound effects department in Hollywood.

More thunder will come from a new type thunder sheet, made of phosphor bronze. The sheet of bronze, 4 feet long and 6 inches wide, gives the same effect as an old-type thunder sheet of galvanized tin 14 feet long.

ECHO CHAMBERS

The loneliest studios in Radio City (New York) are 3 small chambers opening off a narrow corridor on the 9th floor. The only persons who ever visit them are occasional engineers who test the microphones and the nearby amplifier to make certain that everything is in order. Even to enter them, the engineer has to open 2 heavy soundproofed doors, the one immediately behind the other.

It is extremely doubtful if an artist ever set foot in one of these rooms, yet voices and music frequently fill the barren spaces. Recently, when millions of N.B.C. listeners gave ears to Snow White's wishing song on the Rudy Vallee and Johnny Presents program, they became aware of fine resonant echoes. They visualized the wistful princess as singing into the wishing well. That was when the singer's voice rang through an N.B.C. echo chamber.

A radio echo is easy enough to supply, but the fellow who wants one in his program positively has to notify the engineering department in advance. The artist may supply the sound, but the engineer has to furnish its echo—long, short, loud or soft—any kind the artist wants. The technical lads, however, must have a little time to get their echo factory connected with the program.

The N.B.C. engineers have, during the 6 years they have used echo chambers, evolved some neat little tricks. They can, for instance, tack an echo onto one sound and broadcast another sound, from the same studio, "straight." This comes in handy in broadcasting, say, a scene from an antechamber off a great hall where the music of an organ reverberates in vast spaces. It was also used in the 2 broadcasts of Snow White's wishing song, except that here the studio engineer had to do some fancy switching, on and off, of the echo chamber. The artist actually sang the echoed phrases twice; but only the repetition was routed through the echo chamber.

Once the echo chamber has been linked to a program, the key man is the studio control engineer. He controls the amount of echo with a special "fader." Let us say that a pair of actors is supposed to be mounting stairs to a large barren hall. The actors in the studio actually stand still and read their lines into the microphone. All the "walking" is done by sound effects men at a separate mike. The door also opens with the assistance of the sound effects man. Then the control engineer switches on the

(Continued on following page)

THE FIRST TUBE TESTER

with a
LOGTAL SOCKET!



NEW SUPREME MODEL 503 TUBE TESTER

Again Supreme is first with a new roll chart tube tester which includes a LOGTAL socket and a new obsolescence proof, push button type "double floating" Filament Return selector system. You don't have to worry about Logtal adapters or changes in new tubes' filament terminations with this tester. ANY filament termination combination is right at your finger tips with a Supreme 503 Push Button tube tester, most obsolescence proof tester on the market.

The Supreme 503 uses an Improved Balanced Ratio Load Circuit which not only correctly tests all new Logtal tube types 12B1, 7A7, 7A8, 7B4 and other Logtal base tubes as announced regardless of filament termination, and correctly checks the new single ended octal tubes such as the 6SK7, 6SG7, etc., all regular octal and non-octal tubes including the new 1.4-volt filaments, "M," "G," "MG," "GT," plain glass and spray shield types, "BR," "BH," 023, 024, etc., gas rectifiers, all Magic Eye types, Pilot lamps and Ballast tubes in only six sockets. You cannot use the wrong socket. Tubes are given the new Supreme 5-way test for (1) shorts between any two elements, (2) positive visual check for open filaments, (3) standard sensitivity "hot" leakage check between cathode and filament, (4) high sensitivity "hot" leakage check between any two anode elements, or between any anode element and filament or cathode, (5) open test of any elements, (6) all element quality test and (7) separate section tests of multi-section tubes and separate plate tests of full wave rectifiers. Bad tubes are eliminated with clockwork regularity by using this most complete tube test.

The new Supreme 503 tube tester uses a fast acting, non-jamming, easily removable, rotary, two color chart mounted at a central point directly underneath the panel which has been marked with plainly understood arrow-ways leading from each chart number to its correspondingly functional switch. A twist of the wrist gives you the desired tube type setting in large, easily-read figures. No separate chart or booklet in use. Set the controls from left to right. No juggling back and forth over the panel. Insert the tube and you're all set for short, leakage, open or quality tests of any receiving tube type. Fastest tube tester on the market, and so easy to use that its operation is self-evident.

Ample space is provided on the chart for new listings and chart is easily replaceable. New, unique arrangement of leakage and quality push-button gang switch. When making leakage test, each button pressed releases previous button. When making quality test, each button depressed locks automatically, eliminating button "joggling" when more than one button is used. Double spring clip push button switches use heavily plated contacts and self-cleaning wiper blades insuring long life and elimination of switching troubles.

All quality tests are made at proper rated load for highest accuracy and separate test voltages and loads are used for various classes of tubes.

Uses big, 4" square, highly accurate 1 mil movement with a long scale, dead beat pointer, solid forged magnet and real jewel bearings. The 503 has an insulated universal tap cap which is permanently connected—no separate lead to lose. The big, over-sized tapped primary, line adjusting transformer accurately matches line supply to tube tester over a wide variation in line voltages. The beautiful black mat finish and aluminum trim panel with red and ivory fittings insures any service bench perfectly. Is durable and is specially designed not to cause eye strain from reflected lights, so noticeable with shiny panel instruments.

Mounted in a substantial oak carrying case with slip lined cover, with an overize strong leather carrying handle. It has a real professional appearance which will instill instant confidence by customers in your work. Full instructions and supplementary booklet supplied. The Supreme model 503 will not pass tubes which will not operate properly in a radio and thus it will soon pay for itself in greatly increased tube sales. Get this remarkable instrument at your jobber's TODAY!

CASH PRICE \$39⁵⁰

\$4.34 down and \$4.34 per month for 9 months.

SUPREME

SUPREME INSTRUMENTS CORP.,
Greenwood, Miss., U. S. A.

Export Dept., Associated Exporters Co., 145 W. 45th St., New York City ... Cable Address: LOPREH, New York

YOUR LAST OPPORTUNITY TO GET THIS FREE BOOK! Only a few copies of the 1938 RADIO REFERENCE ANNUAL are still available! It's the BIG, FREE BOOK of 64-pages you receive when you subscribe to RADIO-CRAFT. The ANNUAL covers set building, servicing, public address, test equipment, plus a number of other interesting topics. Send your remittance of One Dollar to RADIO-CRAFT, 99-R HUDSON STREET, New York, N. Y., and you will receive a subscription to RADIO-CRAFT for Seven Months, and your copy of the 1938 RADIO REFERENCE ANNUAL will be mailed postpaid immediately.

SOLAR

gives you **MORE** for your money

MINICAP



Catalog upon request

SOLAR MFG. CORP., 599 Broadway, New York

New **RADIO**

WORLD-TIME Indicator Gadget

Just turn the dial of this remarkable new Gadget—insert there the correct time for any short-wave station, no matter where it or you are located! Tells you exactly when and where to tune in any program, anywhere. Gives Schedules Daylight and Greenwich Mean Time, etc. Works instantly, in a flash! Saves Guessing and figuring. Money-back guarantee! Send \$50c now!

RADIO & TECHNICAL PUBL. CO.
Dept. RC-29 45 Astor Pl.
N.Y.C.

10 DAY TRIAL

50¢

COMPARE ITS VALUE dollar for dollar WITH ANY OTHER COMBINATION TUBE AND SET TESTER

Two great RCP instruments—the Tube Tester and Universal Multitester—are combined in Model 800. Tests all type tubes; makes all tests at RMA specified voltages and loads; 4½" square meter; individual hot interelement short and leakage tests; meter line voltage indicator; 8 A.C. & D.C. voltage ranges 0/5/50/500/1000; D.C. milliamps 0/10/100/1000; D.C. ammeter 0 - 10. Ohmmeter 4 ranges from 0 to 10 megs; low ohm measurements below 0.1 ohm; D.B. meter—8 to 55 db. in 4 stages; condenser leakage check and many other features that make this instrument the outstanding "buy" of the season.

Fully equipped for local tubes.

Model 800 combination tube and set tester **\$27.95**

Model 800A combination tube and set tester with Model 500 plus in analyzer unit **\$37.70**

Complete descriptive literature on request. RCP instruments available at all leading distributors. If not stocked by your local jobber order direct and advise name of local distributor.

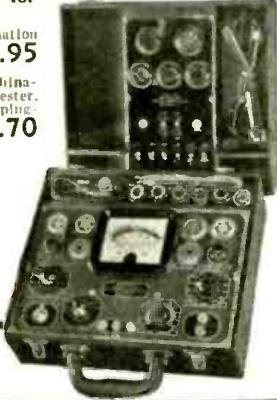

RADIO CITY Products Co.
88 PARK PLACE NEW YORK CITY



RADIO CALLS TRAINED MEN!

• Radio is still young. The industry is expanding. Its future is bright. And radio needs trained men.

Get your training for success the I. C. S. way—the way that has proved itself through nearly 50 years of home-study leadership. I. C. S. Radio Courses can make you an expert in this field of rich rewards. It's up to you!

INTERNATIONAL CORRESPONDENCE SCHOOLS

Box 6677-E, Scranton, Penna.

Send me—free—information on subject checked:

- Radio Radio Service Man
 Radio Operator Electrical Engineer

Name.....

Address.....

PHILCO PARTS FOR DEALERS AND SERVICEMEN

FAST SHIPMENTS made anywhere. Genuine Philco Parts and Tubes.

Send 10c postage for Philco REPLACEMENT PARTS BOOK.

Catalogue sent FREE

WILLIAMS PHILCO Inc.

804 S. ADAMS ST. PEORIA, ILL.

UNIQUE SOUND EFFECTS

(Continued from preceding page)

echo chamber. The next words have a fine large echo, footsteps ring out as in a vast, empty space.

What has happened? The electrical energy representing footsteps and voice has been split. One part was diverted to the echo chamber where it was strengthened and then reconverted into sound in 3 loudspeakers. Each of these loudspeakers is connected to long, cement-lined tubes. One of the tubes is 40 feet long, another 60 and the third 80. All terminate in conventional horns opening into the echo chamber proper.

Sound travels slower than electricity, which has the speed of light. It is apparent also that a sound will be staggered in the 3 tubes. It will come out of the shorter tube first, followed by the same sound at the briefest of intervals from the second and third tubes. That, in itself, is a fairly good start on an echo; but N.B.C.'s engineers like to add a few hundred more faint footsteps and voices to echo the original sound.

So they release it into an echo chamber. This is a room, about 8 feet high, 8 feet wide and 16 feet long. The floor is of cement, covered with a fine-grained linoleum. Walls and ceiling are of smooth, hard plaster, covered with a glossy paint. Altogether, the footfalls and voices have every encouragement to bounce around and multiply before they are picked up at the other end of the room by another microphone. Then these synthetic echoes rejoin the main transmission line where they follow the original sound.

All of this, of course, happens in seconds. There is a slight echo in the main studios at Radio City, but this is considerably less than half the echo in an ordinary living room. (The studio echo measures about 75/100 of a second, while an ordinary living room has a reverberation period of about 1½ seconds, and the echo chamber, bare, resonant and hard, has a period in the order of 3 seconds.)

RECORDED EFFECTS

Until 4 years ago, every sound required had to be produced in the sound effects workshop, frequently requiring intricate operation in the studio. The craft of providing sound effects had grown to such proportions by then, however, that the first of 7 companies now providing phonographic recordings of sound effects began to offer N.B.C. any and every sound that could be captured and canned.

With all the multitudinous sound effects still produced in the broadcasting studio, the N.B.C. library of sound effect recordings consists of about 1,000 discs capable of furnishing the astonishing total of 4,000 different sounds.

One record has the sounds of screams, snoring and typewriting all on one face; and another offers 20 seconds of a Model T Ford running continuously, 40 seconds of the same vehicle starting, running and stopping, and 20 seconds of a Collie dog barking. The library provides numerous common sounds such as railroad trains, airplane motors, shouting and applauding crowds and animal sounds. At that, it is not infrequent that a perfectly live actor will be called into a studio to roar like a lion or crow like a rooster because the necessary sound produced that way can be cued into the continuity with less chance of delay.

It is the sound effects department's policy to use phonographic records only for such sounds as cannot be produced practically within the studio in some other manner, but since railroad trains, airplanes and

many other cumbersome affairs cannot very well be hauled into the studios the turntables are whirling their phonograph records much of the time.

In Hollywood Radio City, new record cabinets, containing 884 bins, hold hundreds of sound effects records, which contain a total of more than 7,500 different sounds, ranging from bird songs to artillery fire.

Historical in its significance is a record of the actual sound of Hitler's entrance into Austria. Marching troops, bursting bombs and rolling artillery wheels can all be reproduced from N.B.C. records.

When New York was in the grip of hurricane winds, sound engineers caught the howling of the gale high up in Radio City. The sound of the hurricane will be heard by N.B.C. listeners through a record added to the Hollywood library.

Church bells, the roar of the *China Clipper*, the rhythm of the goose-step and the screech of a skidding automobile in the Vanderbilt Gold Cup race are a few of the contrasting effects available on records. There is even a record of the actual swarming of bees!

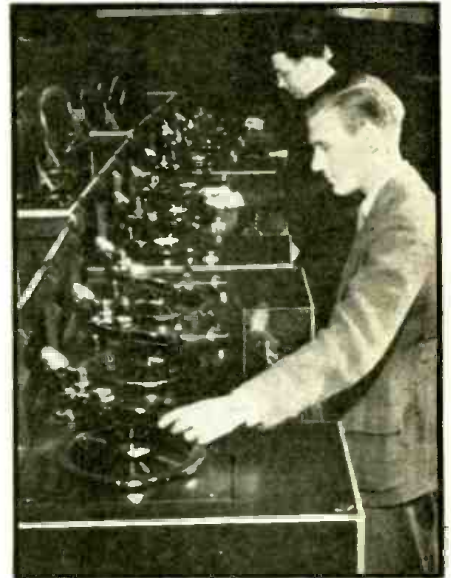

3 MEN ON A SOUND SET-UP

At N.B.C. it's every man for himself, when it comes to operating the 9 sound-effects turntables shown above. The record library includes over 4,000 different sound effects; how many could you think of, offhand?

B.B.C.

When the British Broadcasting Co.'s turn came to do a sound effects job on a broadcast version of "Snow White, etc.," the subject was handled quite differently from the N.B.C. treatment mentioned above.

A pair of scissors and a bowl of pea soup are hardly orthodox "instruments" for use in an orchestra, but Styx Gibling, the drummer, used them as 2 of the many effects he invented for the recent broadcast version of "Snow White and the 7 Dwarfs"; he clicked the scissors in front of the microphone to represent the squeaking of mice, and blew down a tube into the pea soup to make the "witch's cauldron" bubble.

An issue of the *Times of India* some time ago disclosed another unique sound effects arrangement used by B.B.C. to air Robert Louis Stevenson's thriller-novel, "Markheim."

In the story, Markheim murders a dealer in antiques, urged on by the inner voice of

his mind and afterwards he is visited by an hallucination in the shape of Mephisto. It can be readily understood that such a plot, which makes great demands on sound and comparatively little on the visual powers, is ideal for radio. But the producers were up against difficulties in "casting" 2 voices, both disembodied. The mind of Markheim and Mephisto. However, aided by the engineers, they employed a very effective method.

Two separate actors were used and a touch of reality was given to their promptings by the way in which the sound control department manipulated their voices. The "inner voice" of Markheim's mind, as played by one actor, had its harmonics filtered out, and was small, but clear yet unreal. Mephisto, once again with the aid of the engineers who had to control separate microphones, had a similar voice but was allowed to have full harmonics added.

MAKING A SERVICEMAN'S TEST UNIT THE "SUPER-GENO-SCOPE"

(Continued from page 475)

THE SAWTOOTH OSCILLATOR FREQUENCY RANGE AND CONTROLS

Range: 15-25,000 cycles.

Sw.4—Pos. (1)-15, (2)-60, (3)-220, (4)-900, (5)-2,500, (6)-10,000, (7)-(8)-25,000 cycles.

R14 is the Variable Frequency Control which varies the frequency between any 2 points.

The video image of a complete cycle, of the voltage being analyzed, is visible when it is equal to the frequency voltage of the sawtooth oscillator. If the frequency of the oscillator is one-half the frequency under test, 2 cycles will appear, 3-4-5 cycles.

A frequency calibration of the sawtooth oscillator is primarily unimportant due to the instability of the circuit, line fluctuation, depreciation of tubes and parts. Thus an accurate calibration will not retain its accuracy. Also the oscillator frequency is not used as a frequency standard but rather as a sweep frequency in relation to the frequency voltage under observation. The possibility of error also arises in that any such pattern is difficult to stop without recourse to synchronization. This synchronization control will alter the frequency of the sweep circuit thus nullifying its value as a standard.

Up to this point the operator has experienced through the 60-cycle test an elementary interpretation of the pattern design and the manipulation of the various controls. This test should be continued for a number of times especially if the operator is equipped with other sources of various frequencies. More data concerning the practical operation of the oscilloscope section is given in Part IV which follows, in connection with the operation of the Super-Geno.

SERVICE NOTE ON TRIUMPH TUBE TESTERS

To accommodate the new 6SQ7 tubes, all Triumph model 420 and model 430 Tube Testers should have the following additions made in their wiring: terminal No. 1 of the special octal socket should be connected to terminal No. 1 of the standard octal socket, and terminal No. 2 of the special socket should be connected to terminal No. 8 of the regular octal socket. This additional wiring brings these testers strictly up-to-date. Model 430 with serial numbers above 1056 are factory wired to accommodate the 6SQ7 tubes. New tube index charts are available.

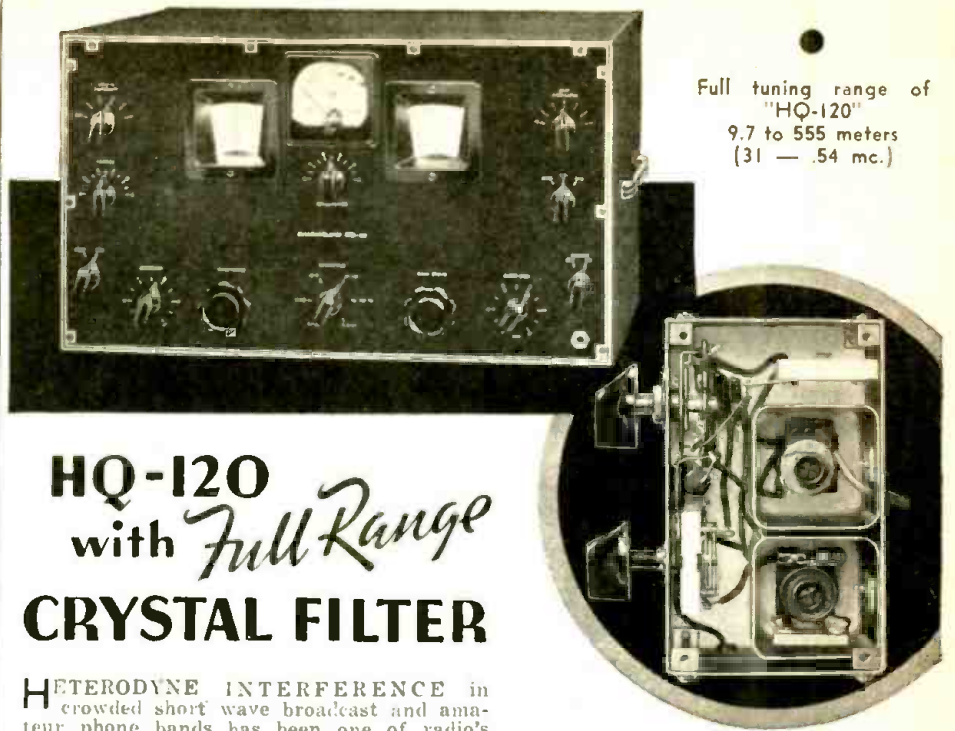

Full tuning range of "HQ-120" 9.7 to 555 meters (31 — .54 mc.)

HQ-120 with Full Range CRYSTAL FILTER

HETERODYNE INTERFERENCE in crowded short wave broadcast and amateur phone bands has been one of radio's greatest problems. It remained for Hammarlund engineers to develop a satisfactory "full range" crystal filter applicable to reception of both voice and music. The use of this variable crystal filter for phone reception allows the operator to phase out annoying heterodyne and splash-over interference and still bring in vocal or musical programs with marked clarity. The phasing control is located on the panel underneath the selectivity switch. No longer is it necessary to wait for an interfering station to sign off or fade out in order to enjoy the program or get the announcement of call letters of some distant transmitter. See curves at right.

There are many other exceptional features that make the new "HQ-120" an outstanding buy for 1939. Consider how many times short wave reception has been made impossible due to automobile ignition interference and similar disturbances. The "HQ-120" has a highly effective noise limiter for just such occasions. Over 310-degree band-spread, with dials calibrated in megacycles; special antenna compensator for improved signal-to-noise ratio; accurate "S" meter for measuring signal strength; beat oscillator; A.V.C.; phone jack, and 10" permanent magnet dynamic speaker make the "HQ-120" a receiver you'll be proud to own.

Write Dept. RC-2 for 16-page booklet

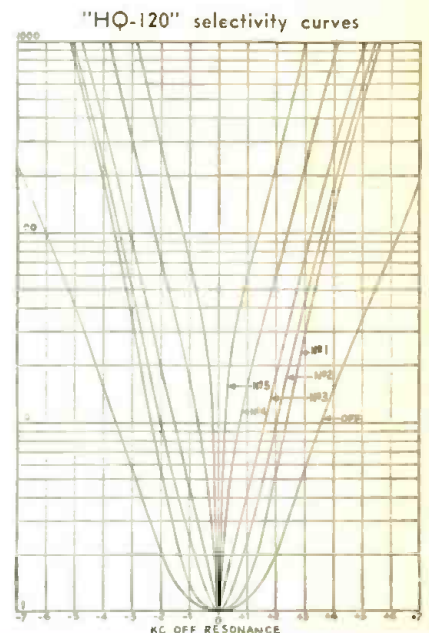

HAMMARLUND MFG. CO., INC.
424-438 WEST 33rd ST., NEW YORK
CANADIAN OFFICE: 41 WEST AVE., NO., HAMILTON, ONT.

GET A BEAUTIFUL DESK LAMP ABSOLUTELY FREE!
Complete details as to how it is possible to get a Beautiful Desk Lamp FREE, appears on Page 509 of this issue.

BRUSH
HIGH LEVELER SERIES
MICROPHONES

Range in price from \$22.50 to \$32.50. New Brush headphones.

Write for your Brush catalog today.

THE BRUSH DEVELOPMENT COMPANY
3312 PERKINS AVENUE CLEVELAND, OHIO

YOUR FUTURE IN RADIO TELEVISION

● These growing industries need trained men for sales, service, operation. Your chance for employment and advancement depends on thorough training. National Schools offer you time-tested training. Complete, modern facilities and equipment in the largest trade school in the West. Established 1905.

NATIONAL SCHOOLS
4000 S. Figueroa Street, Los Angeles

NATIONAL SCHOOLS, Dept. 2-RC, Los Angeles
Please send free Radio and Television Booklet.

NAME _____ AGE _____
ADDRESS _____
CITY _____ STATE _____

INVENTORY CLEANUP SALE

READ THESE PRICES and—

Aluminum Horns for 12" speakers	\$2.95
Portable Cases for 10" speaker and amplifier	1.00
20 Watt Dual speaker portables	29.95
60 Watt amplifiers	36.25
5 Watt Hi-power 2 station intercoms	19.95
12" AC speakers (used)50

Also other amplifiers, portable cases, speaker cabinets, intercoms, P.A. systems. Dozens of items. Rock bottom prices on brand new, standard quality merchandise. Clearing our inventory for 1939. A few used items (indicated) at give-away prices. Several Centralized Radio Systems.

Write for the Bargain Sheet for complete descriptions and listings. Mail order only. No factory pickups. Any distributors having Teletran stocks on hand advise.

—WRITE FOR THE "BARGAIN SHEET!"

TELETRAN PRODUCTS COMPANY

Manufacturers
2233 UNIVERSITY AVE. ST. PAUL, MINN.

NEW CIRCUITS IN MODERN RADIO RECEIVERS

(Continued from page 472)

tached is roughly at ground potential with respect to the voice coil voltage receiving a slight degenerative voltage. As the slider of the volume control is moved down there is increasing degeneration voltage fed back, but since the volume is low its actual amount is low. However, the degenerative voltage constitutes increasingly more of the signal at lower volume levels. At the highest volume the degeneration is still adequate.

If looked upon as a simple bridge circuit, its operation will be very simply understood. The circuit represents a much better application of degeneration than the usual volume control tap method, because of better distribution of the feedback voltage across the volume control.

(3) REGENERATION USED IN SINGLE I.F. STAGE

Stewart-Warner Models 97-561 to 97-569. To achieve the selectivity and gain possible with an I.F. stage, regeneration of the 2nd-detector is used in these circuits.

There is no intermediate frequency amplifier tube in this set, the 1st- and 2nd-detectors being coupled by a single I.F. transformer as in Fig. 1C. The 2nd-detector grid coil is capacity-coupled to the 1st-detector plate lead by means of a few turns of wire wound around the plate lead. The entire grid coil is tuned and tapped for a ground near one end. To this end the 2nd-detector plate is coupled through a trimmer (36) for adjusting the degree of regeneration to a satisfactory stable value.

Voltage is induced into the grid section of the coil from the plate section through autotransformer action establishing regeneration. Regeneration improves selectivity because the resistance losses of the tuned circuit are reduced and it improves gain because a portion of the output signal is added to the input signal.

(5) REMOTE RECORD PLAYER

Wilcox-Gay. An extended application of the phonograph oscillator—which is independent of the type of set, its power supply or any line connection between them—has appeared on the market.

Operating in the lower portion of the broadcast band from approximately 540 to 740 kc., this device diagrammed in Fig. 2B acts as a low-power transmitter. It has less power output than many signal generators used by Servicemen, but is modulated by the output of a crystal pickup. The inner grid and anode grid are used as in an ordinary triode amplifier, while the top cap control-grid and plate serve as a broadcast-frequency oscillator. A radiating wire in the line cord is coupled to the grid coil through a 10 mmf. condenser.

*If at First
You Don't Succeed
Look, Look Again . . .*

because the March issue of *Radio-Craft* will have an entirely new cover! Therefore, if you are a newsstand buyer of *Radio-Craft* and you don't see it anywhere around ASK FOR IT BY NAME.

Merely say, "I want a March *Radio-Craft*."

It will be there for you.

Size of box: 12 1/2" x 8 1/2"

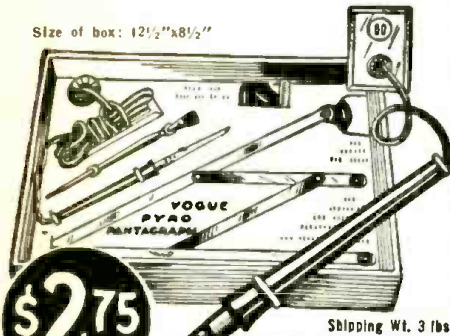

\$2.75

Shipping Wt. 3 lbs.

VOGUE
Pyro
Pantagraph

With this PYRO PANTAGRAPH turn leisure time into profitable hours. Make money a novel, easy way—"Burn Your Way to Extra Dollars with Pyro Pantagraph."

This electrical outfit is especially designed for burning designs permanently on Leather, Wood, Cork, Gourd, Bakelite, etc. Simply plug the Pyro electric pencil in any 110-volt AC or DC outlet and it is ready to be used. Plug and cord furnished as part of equipment.

By the use of a special Pantagraph included in the outfit, any design may be reproduced either in original, reduced or enlarged form.

Outfit consists of: one Pyro-electric Pencil; one Pantagraph; three hardwood plaques; one bottle of Varnish; one Brush; one tracing tip and four-page instruction sheet.

Outfit will be forwarded by Express Collect if not sufficient postage included with your order.

WELLWORTH TRADING COMPANY
558 W. WASHINGTON BLVD., Dept. RC-239, Chicago, Ill.

BROADCASTING— AS I IMAGINED IT

(Continued from page 462)

repeated explorations of the dial to find same.

When one goes to a theater he knows in advance exactly what he is going to see, or to a concert or public address, to hear. If he elects to go to a Catholic church he is quite sure that he will not hear a sermon on Baptism, nor find himself in a congregation of vociferous Holy Rollers. Why then should radio be run on the present hit-or-miss, higgeldy-piggeldy melange program basis? Montage is frequently very thrilling and effective in a motion picture, but it does not follow that the present audible montage of American radio broadcast is either thrilling or pleasing.

As stated above, I do not believe that such an arrangement as I have outlined could be put into effect in these United States without Congressional legislation, accompanied probably by Government subsidy. Such is conceivable however, and I daresay that there are at least a million radio listeners in the United States who would prefer to be reasonably taxed for their radio entertainment provided this was consistent and predictable, rather than to endure the present situation.

I believe that such a situation would result in a great increase in listening hours throughout the United States; to the everlasting benefit of the average American nerves, peace of mind, contented home life—and the radio industry.

But I may be wrong.

Please Say That You Saw It in RADIO-CRAFT

THE RADIO MONTH IN REVIEW

(Continued from page 455)

BROADCASTING (Continued)

the East Lake Country Club last month, according to an *A.P.* report from Atlanta, Ga. Roy S. Mather likes his Sunday golf. He also likes his Sunday football. He solved the problem of how to have his cake and eat it by giving caddy No. 2 the job of toting a portable radio set onto the links to give him the blow-by-blow football air-casts.

Radio's special features men may have their moments—but not all of them enviable. Take for instance the program that carried the on-the-spot impressions of the \$3,000,000 oil blaze at the Cities Service Refinery near Linden, N. J., last month. When a 2 3/4-million-gallon gasoline tank exploded 50 ft. from WOR's "remote" men, shooting the 2-ton lid more than 100 ft. into the air (with the flames up for another 1,000 ft.), listeners heard action sounds as the not-so-"remote" men fled for their lives carrying the portable transmitter.

When the 83,000-ton *Queen Mary* docked under her own power in New York harbor very early one morning last month—without benefit of tug due to a strike—the unusual feat was broadcast. Simultaneously it was recorded, later to be transmitted by shortwave to English listeners via the British Broadcasting system; several hours after the intricate ship maneuver, when a larger listening audience was available, this recording was also aired over the WOR-Mutual net.

Latest stunt on the air waves, according to the radio section of *Variety* last month, is the swiping and rebroadcasting, by certain radio systems, of foreign broadcasts intended only for specific broadcasters in America. N.B.C. is the official objector.

According to *Motion Picture Herald*, last month, Poland, Czechoslovakia, Hungary and Italy have joined Germany in sending a radio representative to this country with a view to facilitating the reception in America of foreign-language broadcasts by domestic and foreign stations.

The All-India radio system described a few months ago in *Radio-Craft* may soon include the proposal made last month by a Colonial Sub-Committee. By the proposed means, one or more central receiving sets in congested areas would deliver their outputs to 200 to 300 loudspeakers so arranged that by the operation of a switch, either of 2 programs could be received. Hence listeners would require only a loudspeaker. The system, said *Times of India* "is particularly suited for those who are rather scared of a wireless set as regards its maintenance."

In *WHK's* program "Voices of the Past," transcriptions bring to listeners the voices of famous statesmen of other years exactly as they sounded on various important occasions. In this station's "History Speaks," authentic dramatized backgrounds are dubbed into transcription discs to which voices of important personages are transferred from old cylindrical records. Professional radio players further act out drama-

tizations from scripts based on historical research, it was reported last month.

An editorial headed "The Radio Investigation," in the *New York Times* last month, remarked: "It is . . . a review (of radio broadcasting) and not a mere grilling of business executives that we expect from the Federal Commission."

It was pointed out however that 700 individually-operated transmitting stations are not the same thing as a single network comprising this number of stations would be. Just as a million stoves in as many city homes fired with fuel drawn from a million cellars are not quite the same thing as a million gas ranges all supplied with gas by a single company. "In the circumstances," said the *Times*, "national broadcasting is necessarily a public utility and as such properly subject to regulation in the public interest."

Insofar as existing networks are concerned, however, coordinated operation seems to have resulted in the development of a highly efficient machine. To use the *Times'* own figure taken from an item of later date, the program service of N.B.C. alone involves an expenditure of \$100,000,000. Such was the figure given by N.B.C.'s vice-President John F. Royal at the 4th session of F.C.C.'s investigations into networks operations.

Vladimir K. Zworykin last month was awarded a decree of priority regarding 14 claims in a 1923 application dealing with a potassium-layer photoelectric cell for use in television. Suit involved Westinghouse, owner of the Zworykin application, against RCA, owner of a Henry Joseph Round patent on a purportedly similar invention. Court opinion was that the patent office erred in awarding priority to Round.

UNCLE SAM'S RADIO STUDIOS

(Continued from page 458)

brary. From that library, the script writers must select judiciously the material best fitted for each particular program.

Production of network programs is done in cooperation with commercial network organizations. Only where the use of existing commercial facilities are impractical, are the studios themselves used. All transcriptions used by the Department, are produced in the studios.

In this way, does the radio audience come to hear what its government, and in particular, what the Department of the Interior, is doing for the public and of its plans for their future.

Except for the recording equipment, the radio apparatus is "RCA, all the way."

A series of ordinary transcription records constitute the oral guest book onto which the voices of the "more important" visitors to the studios place their voices. (Question: Who determines who is "more important"?—*Editor*)

Facilities provide for 12 program lines for reception or transmission of programs; and 12 order lines for communication between studio and point of origin of program (including contact with the Department of the Interior auditorium). An interphone system provides telephone communication over the order wires. The outputs of 4 high-fidelity receivers are fed over lines to offices of chief officials of the various Bureaus and Divisions of the Department.



thousands are enjoying it **FREE**

The radio catalog with thousands of items is the catalog with thousands of friends! And this is the book — Wholesale Radio Service Company's 188-page 1939 edition of the catalog that has everything in radio. It's big. It's new. It's yours absolutely **FREE**. Send for a copy at once. Join the thousands who use this catalog to save important money, to save time and travel, to get the "tops" in equipment at the lowest prices.

Here's what **YOU'RE GETTING**

30 rotogravure pages of new '39 model radios. An important section on transmitters, receivers and accessories to delight the ham. (Some of the big-league names include Hammarlund, Hallicrafter, National, UTC, Weston and Western Electric.) More than half the catalog given over to radio parts, tubes, test instruments and tools of every type. There's a big section on P.A. featuring the new advanced line of Lafayette "Coordinated Sound Systems—the most complete P.A. line in the world. And not to be overlooked, the new Catalog Camera Corner where our old policy of Quality, Economy, Dependability marches on into new fields.

Actually **FIVE CATALOGS**

—five great guides to thrifty shopping-at-home in one big **FREE** book. Any wonder thousands are hailing it today as the world's finest radio catalog? Any wonder you will want your **FREE** copy as soon as you can get it? Any wonder we say—send for it today. . . . **NOW**—while you think of it. Just mail the coupon.

WHOLESALE RADIO SERVICE CO. INC.
 NEW YORK, N. Y. • CHICAGO, ILL. • ATLANTA, GA.
 100 SIXTH AVENUE • 101 W. JACKSON BLVD. • 205 PEACHTREE STREET
 BOSTON, MASS. • BRONX, N. Y. • NEWARK, N. J. • JAMAICA, L. I.

WHOLESALE RADIO SERVICE CO., Inc.
 Dept. 389—100 Sixth Ave., New York, N. Y.
 Rush **FREE** 1939 Radio Catalog No. 73

NAME _____
 ADDRESS _____
 CITY _____ STATE _____
PASTE COUPON ON PENNY POST CARD

Please Say That You Saw It in RADIO-CRAFT

Readrite
RANGER

**A. C. and D. C.
VOLT-OHM-
MILLIAMMETER**

Only **\$12.00**
net



Model 736

HANDY POCKET TESTERS

Model 736 A.C. and D.C. Pocket Tester Readings are: A.C. and D.C. Volts 0-15-150-750; D.C. at 1000 ohms per volt and A.C. at 400 ohms per volt; D.C. Milliamperes, 0-15-15-150; Low Ohms, $\frac{1}{2}$ to 1000; High Ohms, 0-100,000 at $1\frac{1}{2}$ volts. External batteries may be used for higher resistance measurements. Has Triplett instrument. Molded case 3-1/16" x 5 3/4" x 2 1/4". All accessories included.

Model 737—for D.C. readings only. Complete with accessories. **\$9.30**

Model 735—same as Model 737 except operation is simplified by handy selector switch. Complete with accessories. **\$10.80**

READRITE METER WORKS
216 COLLEGE DR., BLUFFTON, OHIO



E. H. NIETZKE PRES. OF CREI

Insure your future!

Start training now in
**PRACTICAL RADIO
ENGINEERING**

Always good jobs for good men . . .

- HERE is the opportunity for you to train yourself for a better Radio Job—at home in your SPARE TIME. CREI has trained hundreds of ambitious men for important positions in broadcasting, aviation, marine and police radio. Constant improvements demand better men for the important, high-paying jobs—and that means a better job for YOU!—if you TRAIN NOW! Today—write for complete details!

Your new copy is ready!

Write for **FREE**
New illustrated booklet
"A Tested Plan for
A Future in Radio"



**CAPITOL RADIO
ENGINEERING INSTITUTE**
Dept. RC-2, 3224-16th St. N.W., Wash., D. C.

FREE **NEW CATALOG
1939 AMPLIFIERS**

Featuring amazingly low prices.
Free Trial Offer, 5-Year Guarantee.
Write for Catalog No. 3911.

AMPLIFIER CO. of AMERICA
17 WEST 20th STREET NEW YORK, N. Y.

RADIO HELPS FIGHT AIR-RAIDS!

(Continued from page 459)

cial broadcasting receivers, manufactured by Invieta Radio, having pushbutton tuning. Contact was established with pilots overhead.

A rather amusing mistake prevented the ground operators communicating with the attacking pilots as they had intended. As this communication would not be made during a war, the mistake was not serious. During the rehearsal, however, the ground operator made such desperate attempts to get into touch with pilots 4,000 feet overhead that his signals were heard in the United States. Intelligent replies were received from the States, but the pilots overhead made no reply. What had happened to them was that they had with them only their Royal Air Force 60 meter sets and were therefore listening on the wrong frequency.

The radio equipment for the rehearsal was under the control of a well-known English radio amateur in Slough, Mr. Peter Dean, known to amateur transmitters as G6DD. He told me that after the black-out, he received reports from radio amateurs in the United States, from Canada and Cuba, where the transmissions had been heard with interest and curiosity. For the future, however, the A.R.P. authorities will have the co-operation of the police for their radio.

It happens that Mr. Dean and his brother are the chief engineers of the Slough Radio Service Company, the firm which has supplied the equipment to our police force in Brighton, Brighton, Newcastle and Glasgow are as yet the only towns in this country to have a radio-equipped police force. They can be heard any evening on 160 meters, using both telephony and C.W.

The equipment used by each constable is a unique invention of Mr. Dean. The constable carries in one pocket a midget receiver like a small, black box the size and shape of a book 9 by 7 inches and weighing under 2 pounds. In the other pocket, he carries a telephone earpiece with a bell fixed to it. This is connected to the midget receiver by a wire. When a call is sent from the top of Brighton town hall, the bell in the pocket of every constable on duty is set ringing. This is a unique calling system, employing a very small relay in each pocket radio set. When the bell rings, the

constable removes the earpiece from his pocket and listens to the message. In the detection of crime, this system has proved of great value. In an air-raid, every constable could receive immediate instructions wherever he might be.

In addition to all this, it has been suggested that the Post Office Radio Section, which is the organization issuing licenses to amateurs, might establish a bureau with powers to issue literature summarizing recent developments in the radio art, special attention being given to the amateur aspect. In a few years, it should be possible to build up quite a useful emergency network, based on direct ray transmission on the 56 megacycle band. This would produce signals inaudible outside this country. If encouragement were offered, no doubt quite a few amateurs would produce sets with a power supply from gasoline motor-driven generators to insure constant communication even when power stations were out of action.

But there are still other ways in which radio can be used in time of air-raids. In one of our largest factories for making preserves of all kinds, namely Crosse & Blackwell, radio has been installed throughout the plant. It has been found that the factory hands work better to the sound of radio programs. Through the public address equipment installed for the radio, messages are to be given to the workers in time of air-raids.

Perhaps the most sensational use of radio, or rather of the loudspeaker in time of air-raids is a new French invention, which has received much publicity in our English papers, especially in *The Times*. A Monsieur Maxim Baze is recording the sounds of battle on phonograph records for use on the battlefield. He claims that the noises would demoralize the enemy and suggests that a mock air-raid could be staged by sending up at night a large kite, invisible from the ground. The kite would be equipped with a loudspeaker which would emit the roar of invading airplanes and the reports of bursting bombs. In this way, it might be expected to shatter the nerves of the enemy and rob them of all hope of sleep. Foreign spies in London would presumably send up the kites. And anyone seen buying a kite at the outbreak of war will at once be looked on with suspicion. (!—Editor)

IS PUBLIC ADDRESS EQUIPMENT OVERRATED?

(Continued from page 476)

can be obtained by increasing the grid resistor is 6 db. above this 90 db. value so that by increasing the gridleak to infinity would gain only 0.3-db. above the 95.7 db. calculated above though the gain as computed by (1) would become greater for every increase in grid resistance. Thus a calculation with a 2 mex. gridleak would give 113 db. gain but all of this 10 db. increase would be offset by a mismatch so that the effective amplifier gain would be slightly less than 96 db. The only possible way to take advantage of the increased input impedance is to use an input transformer to match the generator impedance to the grid resistance. Thus can be explained the apparent discrepancies in the gain rating of amplifiers from various manufacturers.

POWER CAPACITY RATING

Now back to the question of power capacity. It is rather difficult to measure the "distortion content" (or harmonic content) of an amplifier without special equipment. Hence it becomes important that frank and complete statements be made by the manufacturer regarding the harmonic content of the amplifier output when the amplifier is delivering its rated power to the load. Another useful bit of information is the power at which the total harmonic content

is 5%. This would be useful to the Public Address man in deciding what to use in cases where musical quality as well as voice intelligibility is important. In cases where records are played to waiting audiences or to fill in short periods quality is very important and overload distortion should be carefully avoided.

The volume range of an amplifier is limited by the "noise (usually hum) content" of the output. For speech this noise level should be at least 45 db. below the maximum output power in all cases and for high-quality systems a much wider volume range should be available.

MICROPHONE RATINGS

There is at present considerable difference in practice by various manufacturers rating microphones. For instance, one manufacturer rates his microphone at "55 db.," another rates his at "68 db. below 1 volt per bar." In the second case the rating is proper and would be definite if it were stated what impedance the microphone has and is delivering the voltage to.

In the first case the rating doesn't really give any information. To give a power level in db. without stating what is used as a reference or zero-level is really meaningless. However, it has become customary in Public Address work to use 0.006-watt as a standard reference

Please Say That You Saw It in RADIO-CRAFT

volume. Hence a P.A. specialist would be led to assume in the absence of a stated reference level that 0.006-watt is implied as the reference. But this isn't a satisfactory way to rate microphones. The essential thing about a good microphone is that its output voltage be proportional to the pressure in the sound field. Hence to say that a microphone delivers a power 55 db. below 0.006-watt without giving the pressure in the sound field is also meaningless!

It would be convenient to accumulate data on the sound pressure delivered by the average orator (speaker) at a given distance from the microphone and then use such an average as a reference sound pressure. If this were done, and the figure definitely accepted by all concerned, then microphones might be rated in db. below 0.006-watt when in such a sound field. The sound pressure delivered by actual speakers would vary in perhaps a 20-db. range about this reference but the average would nevertheless in some ways be more useful than a more definite rating in "db. below 1 volt per bar into some particular impedance."

The advantage would lie in the fact that no calculation other than addition would be necessary to determine whether a particular amplifier microphone and loudspeaker would be suitable for a given job. The procedure would be as follows:

Suppose standard tables showed that 30 electrical watts were necessary for the size of room in question. This is +37 db. above the reference of 0.006-watt. If the microphone had an output of -60 when rated by the method outlined above it would require 60 db. to raise the level to zero and 37 more to raise it to 30 watts. Hence the required amplifier must be capable of delivering 30 watts and have an effective gain of at least 97 db. when computed as outlined above. It would be desirable to use an amplifier having 100 db., or more gain, to allow for variations of the sound field level about the average used in computation.

LOUDSPEAKER RATINGS

We finish this discussion with a brief comment regarding the efficiency of loudspeakers. In order to calculate accurately the amplifier requirements for any public address job the loudspeaker efficiency must be known. That is, it must be known what fraction of the electrical power delivered to the voice coil is actually radiated in the form of acoustic energy.

A glance through catalogs of jobbers supplying all kinds of speakers will show that almost without exception no figures on efficiency are given! The reason for this is that while it is easy to measure the electrical energy being supplied to a speaker it is by no means easy to measure the acoustic energy radiated. Therefore, very few manufacturers know accurately the absolute efficiency of their units.

Fortunately it is possible by present-day methods to build speakers which radiate as high as 50% of the energy and quite a few of the more efficient commercial models approach 20% in efficiency. The sound level from these speakers is only 7 or 8 db. lower than it would be if all the energy were radiated as sound. The relative efficiencies of similar units from various manufacturers do not usually differ by more than 5 db. from each other. Since most of the data concerning coverage of audiences is empirical and has been taken on systems making use of such reproducers, a workable plan for P.A. design is available which does not require knowledge of the absolute efficiency of loudspeakers.

In closing it should be emphasized that if all the component parts that go to make up a Public Address system are honestly rated according to a sound method it is possible by the simplest kind of calculation to accurately predict in advance the performance which can be expected from a system made up from a particular set of parts without recourse to the usual and sometimes costly experimental method of setting up the whole system for trial.

This article has been prepared from data supplied by courtesy of Sound Apparatus Co.

HOW TO MAKE YOUR OWN HOME TALKIES!

Another interesting article on this increasingly popular field starts in the **MARCH ISSUE**

Don't Miss It!

The Easiest to Operate - - Most Complete SIGNAL GENERATOR Ever Designed!

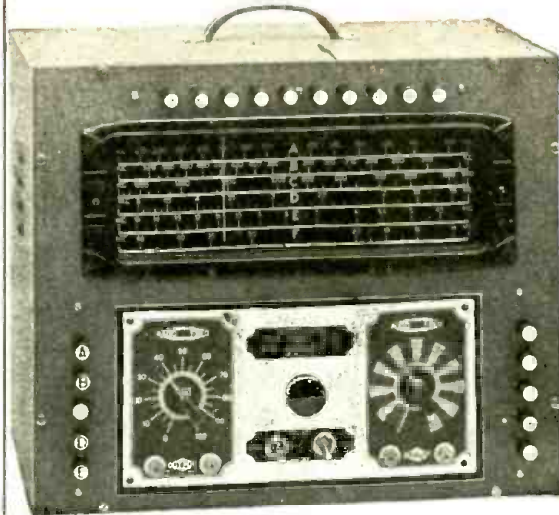

IT HAS THE FOLLOWING

FIXED FREQUENCY

PUSH BUTTONS

175KC—262.5KC

456KC—460KC

465KC—600KC

1000KC—1400KC

1600KC

THE MODEL T 70

A COMBINATION AUDIO AND RADIO FREQUENCY SIGNAL GENERATOR with

ALL PUSH BUTTON CONTROL

A real triumph in radio engineering, this newly designed instrument is actually a combination of two complete instruments in one.

- FIRST** A complete 100 KC to 60 MC radio frequency Signal Generator with the nine most important spot frequencies available by PUSH BUTTON CONTROL.
- SECOND** A complete and continuously variable audio frequency Signal Generator. Range, 5 cycles to 10,000 cycles, divided into five bands, with band switching by the PUSH BUTTON METHOD.

SPECIFICATIONS

1. Works on 90 to 130 Volts A.C. or D.C. (any frequency). 2. Generates radio and intermediate frequencies, 100 KC to 60 MC in five bands selected by push button switching. Accurately calibrated on 10-inch oblong (Vowve vernier) dial. Accuracy: 1/2 of 1% on I.F. bands, 1% on broadcast and short waves. 3. The following 9 spot frequencies available by push button control: 175 KC, 262.5 KC, 456 KC, 460 KC, 600 KC, 1000 KC, 1400 KC and 1600 KC. 4. The volume control, or attenuator, works well on all bands, which attests to the very low order of leakage. The shield cabinet, special filters and other precautions keep this leakage, ordinarily a nuisance, to a very low and unobjectionable level. 5. Generates audio frequencies from 5 cycles to 10,000 cycles in five bands, selected by push button switching, accurately calibrated on etched panel. The audio output is serviceable as modulation on all I.F. and R.F. bands and may also be taken out independently. 6. Housed in beautiful new army grey crystalline finished cabinet, front panel is of etched frosted grey aluminum.

Model T-70 Signal Generator, complete with tubes, test leads and instructions. Size 13 1/2" x 11 1/4". **\$1940**
Shipping weight 18 pounds. Our net price.....

TEST EQUIPMENT COMPANY OF AMERICA 139 CEDAR STREET, Dept. RC-239, NEW YORK, N. Y.

Do you know how easy it is to keep your shop up to the minute with latest high efficiency test equipment . . . the NATIONAL UNION WAY? HERE'S WHAT YOU DO:

YOU FELLOWS WHO USE NATIONAL UNION RADIO TUBES and CONDENSERS KEEP ME BUSY GIVING YOU SHOP EQUIPMENT ALL YEAR 'ROUND

1. Select the equipment you want.
2. Sign a National Union Tube and/or condenser purchasing agreement.
3. Place a small deposit which will be refunded to you as a merchant's credit when your purchasing agreement is completed.
4. Order a small quantity of National Union tubes and/or condensers at the time you sign the agreement.
5. Apply your regular monthly purchases of tubes and condensers against the requirements of the contract.

Come on! Build Customer Confidence with NATIONAL UNION TUBES and CONDENSERS!

For name of nearest Distributor write RC-239

NATIONAL UNION RADIO CORP'N. NEWARK, NEW JERSEY

Please Say That You Saw It in RADIO-CRAFT

This 1 B G BOOK Teaches You

Here's Your Complete Radio Education:

- Sound, Speech and Music —
- Electronics —
- Electric Current —
- Units and Circuits —
- Resistance —
- Ohm's Law —
- Batteries —
- Magnetism —
- Electromagnetism —
- Transformers —
- Inductance —
- Condensers —
- Alternating Current Circuits —
- Filters —
- Electrical Measuring Instruments —
- Radio Waves; Radiations —
- Broadcast Stations —
- Receiving Equipment —
- Vacuum Tubes —
- Radio and Audio Frequency Amplification —
- Superheterodynes —
- Loud Speakers —
- Battery Operated Receivers —
- Power Supply Units —
- Electric Receivers —
- Automobile and Aircraft Receivers —
- Phonograph Pickups —
- P. A. Systems —
- Short-Wave Receivers —
- Photoelectric Cells —
- Television —
- Antennas and Grounds —
- Testing and Servicing Receivers —
- Sound Motion Pictures —
- Appendixes —
- 850 Review Questions for Self-Study —
- AND DOZENS OF OTHER SUBJECTS!

972 PAGES
508 Illus.
856 Review Questions

ALL about RADIO!

In 30 separate self-study courses this handy 1-volume edition of Gilchrist's famous Radio Physics Course takes you quickly over the entire field of Radio, Electricity, Sound, Television, Cathode-Ray Tubes, etc., etc. It's all here—all you need to fit yourself for a good radio job. Yet it's all made so crystal-clear and you cover the ground so rapidly that it doesn't seem like studying at all.

SIMPLE AS A.B.C.!

It's fun to learn radio this way! No mathematics, no preliminary training. You start right in the day you get the book. Read it like you would a novel. Hundreds of illustrations make the fascinating story more vivid and enjoyable. Check up on your progress with self-testing review questions. Never before has it been possible to master the whole science of radio so easily, so quickly, and so economically! Thousands have received their training in radio from this practical source. It's used by more radio schools and students than any other radio book in the world! Here is YOUR chance to get started in "the profession with a future." Prepare for it now—TODAY!

\$4 only Money-Back Guarantee!

RADIO PHYSICS COURSE

ALFRED RADIO & TECHNICAL PUBLISHING CO., 45 Astor Place, New York, Dept. RC-29

Here is \$4 (plus 50¢ foreign) for my copy of RADIO PHYSICS COURSE. Ship postpaid at once with 10-day money-back guarantee.

NAME

ADDRESS

CITY STATE

Please send me free descriptive literature.

6-VOLT UNIVERSAL POWER PACK

LISTS \$15.00

At Less Than Price of Prong Synchronous Vibrator Alone!

Operates 6 volt set from 6 volt storage battery, also operates 6 Volt house sets, auto sets, S.W. transmitters and receivers. Output, 150 Volts at 50 M.A. On a 10 cell supplies 120 Volts at 30 M.A. Housed in case 3"x4 1/2"x8 1/2". Shipping Wt. 6 lbs.

Only \$32.95 NET

25% Deposit Required with Order. Balance C. O. D.

ARROW SALES CO. 27 S. JEFFERSON ST. CHICAGO, ILL.

EVERYTHING IN RADIO!

A COMPLETE SOURCE FOR YOUR RADIO NEEDS

Our immense stock of radio sets, parts and supplies enables you to purchase your entire needs on one order. You will find all your Nationally Known Favorites in this big book—FREE! For the asking. Practically every order is shipped the same day it is received.

WRITE FOR BIG NEW CATALOG

BURSTEIN-APPLEBEE CO.
1012-14 McGee St. • Kansas City, Mo.

MAKE YOUR OWN "TALKIES"!

With MILES Patented "FILMGRAPH" a sound track can be recorded on the edge of any 16 mm. film which converts your silent film and silent projector into Sound Apparatus without cost for recording and reproducing. 84 minutes of recording may be had (without pictures) on a 100 feet of 16 mm. film costing only 85¢. Recordings made and played back instantaneously. Moderate initial cost—only

MILES REPRODUCER CO., INC.
812 RC BROADWAY, NEW YORK, N. Y.



Calling Square Dances



Bingo Parties



Club Meetings



Public Address

NEWEST-TYPE WIRELESS PHONOGRAPH WITH MICROPHONE

(Continued from page 463)

to the attachment terminals marked Pick-up."

Radio-Craft later introduced the use of the microphone in this connection in a simplified unit. (See "How to Make a P.A. Beginners' A.C.-D.C. Public-Address Adapter." by R. D. Washburne and N. H. Lessem, in the May 1935 issue.)

These devices of course were the outcome of the carrier current telephony article published exclusively in the November 1933 issue of Radio-Craft. (See "A Wired Radio Public-Address System." by David R. Freeling.)

In view of the Government regulations in force at that time prohibiting the operation of what was then construed to be a miniature transmitting station, Radio-Craft did not stress the fact that these wireless units could be operated sufficiently close to the receiver as to make it unnecessary to connect one to the other. Last month however the Federal Communications Commission released form No. 30678 entitled, "Concerning Rules and Regulations Covering the Operation of Low-Power Electrical-Frequency Devices," in which—apparently due to popular demand—limited operation of such devices is permitted.

DESCRIPTION

The SPARTON Wireless Phonograph consists of an all-electric record player with crystal pickup and matched microphone (a magnetic loudspeaker, operating as a "transducer"), which can be used with any make of broadcast radio receiver, without disturbing in any way the wiring of the radio receiver.

Either 10- or 12-inch records (78 r.p.m.) may be played through the regular broadcast radio receiver. The special high-quality microphone which plugs into the record player enables any person to sing, talk, hum, whistle, etc., and have his voice heard through the radio set, either with or without the accompaniment of recorded music.

The Wireless Phonograph functions with no wires whatsoever connected to the radio receiver. A built-in antenna wire is provided, which need not be removed for normal room-to-room operation. If greater distances are required, it may be used in making a direct connection to the antenna post of the receiver. This will provide better results in cases of excessive local interference.

The Wireless Phonograph is grounded internally—under no conditions should a ground wire be attached.

As soon as the record is heard playing through the radio receiver, check for proper tuning of the music in the same way that a radio station would be tuned in. The volume and tone controls of the radio receiver may be adjusted to suit individual "tastes."

"WIRELESS MICROPHONE"

To use this instrument as a "Wireless Microphone," insert the 2 tips at the ends of the microphone cord into the tip-jacks located on the back of the Wireless Phonograph.

The operator may now play a record and sing, whistle, talk, etc., into the microphone and the voice of the operator will be heard coming from the radio receiver, accompanied by the record.

The microphone may be used separately, simply by turning the control knob to the first position so that the pilot light is illuminated, but the turntable does not operate. When using the microphone only, the tone control of the radio set should be turned up to provide the best quality for natural voice reproduction.

If the microphone is used too close to the loudspeaker of the radio receiver, a howl may result similar to that which is experienced when a telephone receiver is held closely in front of the mouthpiece. Should this be experienced, simply select a new position for using the microphone and Wireless Phonograph which will be more to one side or to the rear of the radio receiver. Turning down the radio volume control may also result in clearer reproduction.

FUN AND PROFIT

There are many additional uses to which this type of instrument may be put; not only for entertainment but also most profitably.

For instance, it may be used for playing your favorite records through any radio set regardless of size, age or make.

Entertaining your family and friends by using the microphone with musical records as described above, or by omitting the recorded music, simply using the microphone alone, is lots of fun.

Try moving the Wireless Phonograph and Microphone to another room and mystifying your friends with your own program "dedicated" to them.

Or, you may want to place the Wireless Phonograph and Microphone in operation in the children's room or near the baby's crib so that members of the family near a radio receiver in another part of the house will be instantly aware of any trouble or emergency. Any sounds of the nursery or crying of infants can be heard plainly through the radio set when it is tuned to the Wireless Phonograph, due to the extremely high sensitivity of the microphone.

The Wireless Phonograph is especially adaptable to use at Bingo Parties where the person calling numbers can speak into the microphone and be heard through one or more radio sets placed in different rooms or in a large hall.

The presiding officer at Club Meetings or Sales Meetings will find the Wireless Phonograph a distinct help in holding the attention of the group by having his voice carried to all members through one or more radio receivers (as described above).

Calling Square Dances is another of the many ways in which the Wireless Phonograph and Microphone can be used. The dances may be called while the dance record is playing.

Charity bazaars also offer many possible uses for the Wireless Phonograph and Microphone.

The microphone alone may be used di-

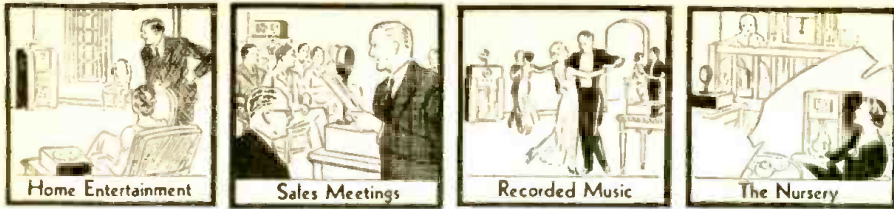

rectly with any radio receiver equipped with phonograph tip-jacks. Simply plug the two tips at the end of the microphone cord into the jacks on the radio receiver and operate the set in the same way as for playing records.

SERVICING

Failure of the Wireless Phonograph to operate properly may be due to the radio receiver not operating properly or not being tuned to the Wireless Phonograph (approximately 1.550 kc.).

Also, a defective tube may result in poor operation; the grid cap of the tube, for instance, may be loose or off.

Incidentally, a not infrequent cause of trouble is lack of current at the light socket.

Attempting to operate the Wireless Phonograph at too great a distance from the radio receiver is another trouble "teaser." If extremely great distances are required, it may be advisable to connect a wire from the Wireless Phonograph to the Antenna ("A") post of the radio receiver.

"TUNING" THE WIRELESS PHONOGRAPH

Since some radio receivers do not tune beyond 1.500 kilocycles a trimmer adjustment is provided in the Wireless Phonograph which will allow the operation of the little "broadcast station" at any point between approximately 1,200 kilocycles and 1.550 kilocycles.

This trimmer adjustment can also be used in case it is desired to operate the Wireless Phonograph at a different kilocycle point (1.550 to 1,700 kc.) in order to avoid interference from some local station.

Using an insulated screwdriver, engage the slotted trimmer (which is reached through the hole in the bottom of the cabinet) and adjust it clockwise to increase the output frequency.

Before making any adjustment to the trimmer, however, it is very important that

the Serviceman know just when the trimmer has been turned far enough.

If the radio set has a Viso-Glo, Magic Eye or other visual tuning device, it will be at once apparent when the trimmer of the Wireless Phonograph has been adjusted to the radio dial setting which was selected.

In case the radio receiver has no visual tuning indicator, a convenient way of determining when the desired frequency adjustment has been reached is to plug into the microphone tip-jacks and, with Wireless Phonograph in another room, talk into the microphone and have some other person listen to the radio set. When the voice is heard coming clearly through the radio set the trimmer has been properly adjusted.

When the microphone is being used for singing with music from records, use a fibre or soft-tone needle for better blending of the voice with the record.

For dance music, etc., when the microphone is not being used, use a medium-tone or loud-tone needle.

The commercial instrument is available in 2 models. The type 219-P is illustrated; the de luxe model 219-PD has a carrying case. As shipped from the factory these units are tuned to radiate at a frequency of 1.550 kilocycles.

Table I is a voltage chart of the models 219-P and 219-PD instruments.

CIRCUIT VARIATION

Original production models did not have resistor R6 and condenser C10 in the circuit shown in Fig. 1. In these first-run production sets resistor R1 connected across the microphone tip-jacks in the same position as shown for resistor R6. The above change can be made easily when servicing any of the first-run models 219-P wireless phonographs. For 220-V. cycle operation break the circuit at "X" and use a suitable input resistance cord. The on-off switch is shown in the counter-clockwise position.

**TABLE I
VOLTAGE CHART**

Tube	Voltage of Socket Prongs to Gnd. (Chassis)								Grid Cap
	No. 1	No. 2	No. 3	No. 4	No. 5	No. 6	No. 7	No. 8	
6A7	0	120	80	4.5	0	4.5	6.3*	—	0
25Z5	6.3*	117*	150	150	117*	31.3*	—	—	—
BK-80B	0	—	117*	—	—	—	31.6*	37*	—

Line Voltage: 115 V.; control switch in center position. Antenna and microphone not connected.

NOTES: Allow 15 per cent + or - on all measurements. Always use meter scale which will give greatest deflection within scale limits. All D.C. measurements made

with 1,000 ohms/volt voltmeter. All A.C. voltages made with rectifier-type voltmeter. Unless designated otherwise, voltages in table are + D.C. voltages.

*A.C. volts.

RECENT F.C.C. RULINGS ON "WIRELESS" DEVICES

Rule 25.01. Pending the acquiring of more complete information regarding the character and effects of the radiation involved, the following provisions shall govern the operation of . . . low-power radio frequency electrical devices . . . (As for instance, the "wireless" phonographs and microphones, and remote tuning units recently marketed.—Editor)

Rule 25.02. With respect to any apparatus which generates a radio frequency electromagnetic field functionally utilizing a small

part of such field in the operation of associated apparatus not physically connected thereto and at a distance not greater than

$$\frac{157,000}{f \text{ (kc.)}} \text{ ft. } \left\{ \frac{\lambda}{2\pi} \right\}$$

the existing Rules and Regulations of the Commission shall not be applicable, provided:

(a) That such apparatus shall be operated with the minimum power possible to
(Continued on page 510)

REAL Short Wave RECEPTION with R. F. STAGE CRYSTAL FILTER



NEW MODEL 438

**8 Tubes
4 Bands
To 7 meters**

Only
\$49⁹⁵
less crystal

complete with tubes and speaker

JUST EXAMINE THESE FEATURES:

- Ceramic Coil Forms . . . R.F. Stage on All Bands
- Separate Coil for each Band . . . Xtal Filter . . . Complete Band Coverage 540 KC — 43 mc . . . Electric Band Spread with vernier control . . . 2-Stage Iron Core I.F. . . . Accurately Calibrated Slide Rual Dial . . . 8 Tubes . . . Provisions for a 6-volt Power Supply . . . Band in use Indicator . . . B.F.O. with Pitch Control . . . 2 Watts Power Output . . . Built-in 6" Dynamic Speaker . . . Head Phone Jack . . . Doublet or Marconi Antennae Connections . . . Provision for External Speaker . . . REAL professional performance at the remarkably low price of \$49.95. Our new Model 438 will bring joy to those radio enthusiasts who have been looking for good short wave reception particularly in the 10 meter band at a price they could afford.

Howard is the Talk of the Air Waves

This big brother of the world renowned 430 will certainly earn its place in the heart of the critical professional, amateur and short wave listener.

*Pacific Coast and Export Prices Slightly Higher
AMERICA'S OLDEST RADIO MANUFACTURER

Free For Complete Technical Information Send This Coupon or See Your Jobber.

HOWARD RADIO COMPANY
1731-35 W. Belmont Ave., Chicago, Ill.

Please send me complete technical information on Model 438.

My name is _____

Street Address _____

City _____ State _____

CABLE ADDRESS: "Howardco"

QUALITY—VALUE—GUARANTEE!

WESTINGHOUSE POWER GENERATOR

Manufactured for U. S. Signal Corps

A. C. ELECTRICAL POWER

from a Windmill, from available Waterpower, from your Automobile, from your Motorcycle, from your Bicycle, Footpedals or Handcrank (for transmitting Radio Transmitters, Strong Floodlights, Advertising Signs); operate two generators in series to get 200 V. AC; obtain two phase and three phase AC, etc., etc.

There Are Over 25 Applications

Some of which are:
A.C. Dynamo lighting, from eight to ten 20 watt 110 Volt lamps. Search Light. Wave Transmitter supplying 110 Volts AC for operating "Ham" transmitter. Motor boat, Public Address Systems, Electric Signs on motor boats, yachts, etc. Camp Lighting. Short wave artificial "beaver" apparatus. Television. Pelton Waterwheel for lighting or other purposes. Airplane, for lighting strong search lights or electric signs. Laboratory work, etc., etc.
1/4 to 1/2 H.P. needed to run generator.

Generator as described, including BLUE PRINT 22 x 28 in. and Four-Page 8 1/2 x 12 in. INSTRUCTION SHEET \$7.90
Send \$2.00 deposit balance C.O.D. Shipping weight 18 lbs.

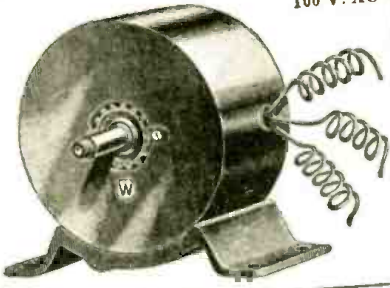

200 Watt.
100 V. AC

WESTINGHOUSE UNIVERSAL MOTOR

\$2.55

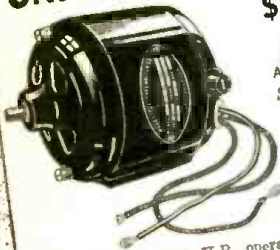

110 Volts
AC and DC
Shipping
Weight
3 lbs.

Specifications: 1/30 H.P. operates on either A.C. or D.C., 110 volts, 5000 R.P.M. Rheostat can be used to vary speed. Height 2 1/2", Length 3 1/2", Width 1 1/2", Shaft 1/4", one inch long. Can be used to drive Sewing Machines, Motors, Buffing Lathes, Polishing Head, Drills, Grindstones, etc., etc.

MOTOR only \$2.55
MOTOR with Arbor and 1/4" Chuck \$3.55

MOTOR with Arbor and 1/4" Chuck \$3.55
Add 25c for special packing and mailing anywhere in U. S. A.

G. E. PHONOGRAPH MOTOR

Formerly Sold for \$15.00

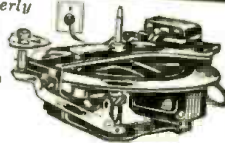

\$ ONLY 4.95

Variable speed induction type self-starting. 110 volt, 25 to 60 cycle. A.C. with speed control, plug and cord. Speed range from 5 to 200 R.P.M. Can be installed in place of old-fashioned, hand-wind and a hundred other uses. These General Electric Motors have never been used and come four packed in original carton. G. E. Electric Phonograph motor as described (with-out turntable) \$4.95

Shipping Weight—12 lbs.

ALL OUR MERCHANDISE IS UNUSED AND SOLD ON A MONEY-BACK GUARANTEE

MICROPHONE AND RECEIVER

This Microphone and telephone headset outfit was built especially for the U. S. Navy Aviation Corps, the outfit to Government specifications.

The outfit consists of a low-impedance carbon microphone (transmitter), securely fastened to a metal breastplate, and a set of heavy-duty, low-impedance earphones. A specially constructed switch on the back of the breast-plate controls the microphone circuit. The earphones are U.S.N. type, attached to adjustable headband. Twenty-eight feet of very heavy-duty, waterproof conductor cable is furnished. Current storage battery is the most satisfactory current supply.

U. S. Navy Airplane-type Microphone and Receiver as described \$4.96

Shipping Weight—9 lbs.

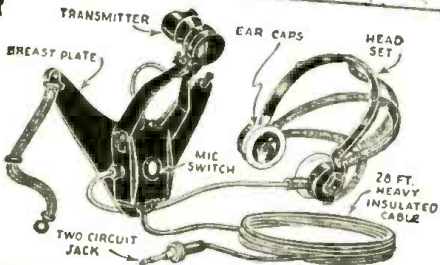

WELLWORTH TRADING CO.

Dept. No. 235

560 W. WASHINGTON BLVD., CHICAGO, ILL.

★ ORDER DIRECTLY FROM THIS ADVERTISEMENT ★

WE SHIP 24 HOURS AFTER RECEIPT OF YOUR ORDER, BY EXPRESS COLLECT OR PARCEL POST IF YOU INCLUDE SUFFICIENT POSTAGE.

Print Your Own

Cards, Stationery, Advertising, labels, paper, circulars, tags, etc. Save money and time. Sold direct from factory only. Junior outfit \$8.25, Senior outfits \$17 and up. Do popular raised printing like engraving with any of our presses. Print for Others, Big Profits Pays for itself in a short time. Easy rules sent. Write for free catalog of outfits and all details. Kelsey Presses N-97, Meriden, Conn.

EXCELSIOR

PATENTS—TRADE MARKS

All cases submitted given personal attention by members of the firm.

Form "Evidence of Conception" with instructions for use and "Schedule of Government and Attorneys Fees"—Free

LANCASTER, ALLWINE & ROMMEL
PATENT LAW OFFICES

436 Bowen Bldg. Washington, D. C.

WE HAVE The RADIO YOU WANT

Our 1939 catalog is chock full of new Standard Brand Radios for Home-Farm-Auto. Over 400 models. Also hundreds of Electric Appliances for the home. Celebrating our 50th Anniversary with Big Bargains. Write for your copy today. It's FREE.
MODELL'S Dept. 57 Cortlandt St., N.Y.C.

Correspondence Courses in RADIO and ELECTRICAL ENGINEERING

ELECTRICAL ENGINEERING Get good grasp of wide electrical field. Prepare yourself, at Low Cost, for secure future. Modern, simplified, you can understand quickly.
RADIO ENGINEERING Extra fine course in radio, public address, photo-electric work. Train you to be super-service man, real vacuum tube technician. Exper. kits furnished. Diploma on completion. Tuition, \$25, either course. Deferred payment plan.
FREE Get copies of school catalogs, student magazines, complete details. SEND NOW!
LINCOLN ENGINEERING SCHOOL, Box 931-C2, LINCOLN, NEBR.

OPERATING NOTES

(Continued from page 477)

mote possibility, power losses at a minimum, and to facilitate checking and easy replacing of these condensers and resistors, connections were made on 1 in. porcelain stand-off insulators. The leads from this box to the photocell compartments of the projectors were run in 1/4-in. Greenfield flexible armored cable, Number 14 rubber-covered copper being used. A flexible cable, such as was formerly used to couple the photocells to the amplifier, worked very satisfactorily for coupling the condensers to the grid of the input tube. After extensive tests it was found that the grid lead was not nearly so susceptible to inductive pickup as was the old-type leads to the photocells.

J. T. MORROW

SPARTAN 616M

Frequently these sets come in with complaints of distortion and tuning dial noises—this particular set more so than other Spartan models. This may be remedied by the following:

Check all tubes carefully, especially the output tube, 6F6. Now turn set on and let it warm up at least 5 minutes, and test for stability and oscillation. This is a very sensitive set and must be in perfect alignment. Be sure that careful and accurate alignment is given to the set after it has thoroughly warmed up. Special attention must be given to trimmers of the shortwave coils found on top-front of chassis by tuning condenser, always bearing in mind not to adjust the set too sharp as this causes A.F. distortion, especially on high-cycle notes.

Assuming all this is correct or has been corrected, next is to remedy tuning noises, by this we mean the dial making a scratching noise when turned, that can become so loud at times that the signal cannot be heard. This is a fault either in the mechanical or physical side of a set. Check the gang tuning condenser, which is a floating type mounted on rubber. Tighten the condenser's mounting screws. Clean all dust collected on and around condenser. This is important!

Next be sure that flexible wires running from condenser to tube tops (two of them) make good contact at each end; tighten well. This may be half of your trouble.

It has been found that the shielded wires running from bottom of condenser through chassis are most causes of tuning noises. Be sure each wire makes good contact. Take off and clean as sometimes rust or corrosion accumulates here. The holes in the chassis are large enough to prevent the wires from touching the chassis. Be sure wires are in exact center so as not to rub or make contact with the chassis. Tighten all parts well, using a little oil on condenser bearings; being careful not to overdose these bearings so the oil runs down on chassis. (Suitable for this use is an electric oil used in all musical valve instruments.)

The set is mounted in cabinet on rubber. If rubber mountings are worn out, replace.

By placing a flat sheet of metal shielding between rubber mounting and chassis, or cabinet, so it is held in place when chassis is screwed to cabinet, the set is greatly improved as to alternating hum or hum set up by the speaker field. Be sure the extra shielding is grounded well to the chassis, either by screws or soldering.

Outside of what has been mentioned this set should be easy to service, as all parts are well made and easily acceptable.

H. J. HUEBNER

THE LATEST RADIO EQUIPMENT

(Continued from page 478)

MAGNETODYNAMIC PHONO PICKUP (1717)

(Lansing Manufacturing Co.)

HERE at last is a moving coil pickup designed especially for lateral recordings. It generates a voltage which is in direct proportion to the needle point velocity from 30 to 10,000 cycles, without distortion. Its low needle impedance and its extremely light weight (6 to 30 grams) on the record permit as many as 500 playings of the record without damage.

RESISTOR LINECORD AND "TUBE" TESTER (1718)

(ClaroStat Mfg. Co.)

A LONG-AWAITED resistor tester, especially designed for testing the "tube"-type and power linecord resistors, is now available as the model 160 tester.

Tester has indicating meter, prong-selector switch, octal and UX (resistor-"tube") sockets, and A.C. outlet receptacle for testing resistor linecord (and pin-jack for testing other linecord types). Meter has "GOOD-BAD" scale. Steel case, 2 x 5 3/4 ins. sq., is finished in "wrinkled gray."



Tests resistor cords and "tubes." (1718)

PUSHBUTTON TUBE-TESTER HAS ROLLER CHART (1719)

(RCA Mfg. Co.)

NEWS important to Servicemen is that RCA has announced a "new, highly efficient radio tube tester designed for simplicity of operation and incorporating the experience of the world's largest radio tube manufacturer." Unit is made in counter and portable types. Case is finished in "gray wrinkle lacquer" with metal trim. Power consumption, 25 W.; uses 1 rectifier tube; weight, 14 lbs.; measures 13 1/2 x 8 x 5 3/4 ins. deep. Requires no line voltage adjustment before inserting tubes for test. Has 11 push-buttons; and roller chart for control settings.

The tube-tester has 6 sockets, including one spare to minimize obsolescence. All types of gas tubes, such as the 0A4-G, 0Z4-G, 874, and others; ballast tubes; and battery tubes, including the newly-developed 1.4-volt types, may be tested. It will test 1- and 2-inch cathode-ray tubes for shorts and emissions, and will discover noisy welds and circuit breaks in 4-prong and octal-base ballast tubes. Magic Eye tuning indicator tubes may be tested for brilliance and for opening and closing of the eye.

The new instrument makes all tests according to R.M.A. standards. Line vol-

tage adjustment is provided to adapt the unit for 100 to 125 volt line power.

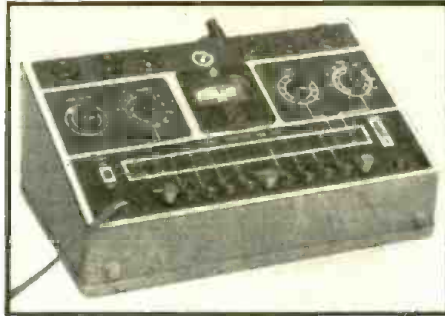

Roller-chart button tube tester. (1719)

LOGARITHMIC VARIABLE CONDENSER (1720)

(General Radio Co.)

"STRAIGHT line frequency" (logarithmic-scale) variable condensers have been available only as integral elements of a tuned circuit in which the constants of, primarily, the coil were accurately known. For this reason only manufacturers—and those mostly set makers—producing both the condenser and coil as a balanced unit were able to offer this desirable combination (in which the dial reading varies in direct proportion with frequency).

A new "S.L.F." condenser, of especial interest to experimenters, overcomes the problem by combining in it 2 variable sections on 1 shaft. One section, the larger, does not introduce any appreciable variation, over an appreciable portion of the medium- and high-capacity range of the condenser. The other section, consisting of 2 rotors and 2 stators, functions primarily over the low-capacity portion of the range; the slotted rotors provide correction of calibration irregularities and possible discontinuity at the overlap region of the 2 sections. Capacity range of this type 739-A condenser is 28 to 468 mmf. (for use, mainly, in beat-frequency oscillators).

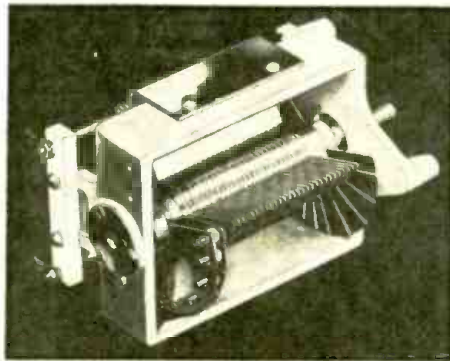

Straight-line-frequency condenser. (1720)

"VACUUM" FIXED CONDENSERS (1721)

(Eitel-McCullough, Inc.)

"COMPRESSED AIR" condensers, in which the dielectric constant was increased by using air under considerable pressure, were well-known to old-timers, but, a "vacuum"-type transmitting condenser is something a bit off the beaten path. It is the shortwave hams that benefit mostly by the newer construction.

(Continued on following page)

Please Say That You Saw It in RADIO-CRAFT

Only



TYPE CS

VOLUME CONTROLS

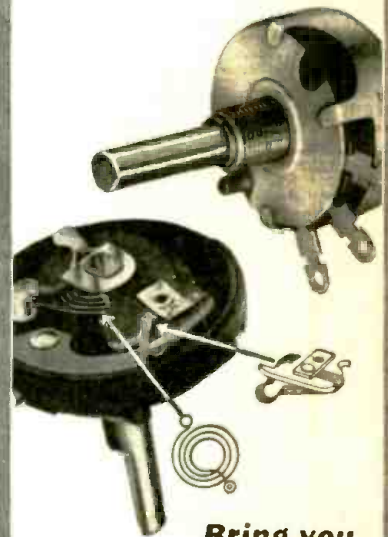

Bring you

RADIO'S MOST EFFECTIVE NOISE ELIMINATING FEATURES

- ① Silent Spiral Connector
- ② 5-Finger Knee Action Silent Element Contact

... each equally important, each pioneered and perfected by IRC. The combination of these two features plus the outstanding dependability of the famous IRC Metallized type element insures better performance under all conditions than any other known construction.

INTERNATIONAL RESISTANCE COMPANY
401 N. BROAD ST., PHILADELPHIA

STOP, LOOK & BUY!

Rockbottom Prices on Surplus, and Army and Navy Merchandise

When prices are low we buy! They're low now—**LOWER THAN THEY EVER WILL BE**—hence this sale. Most of the merchandise is new—never used; some of it reconditioned. 100% satisfaction on each transaction or your money refunded.

ORDER FROM THIS PAGE. Use the convenient coupon below. Be sure to include sufficient extra remittance for parcel post charges, else the order will be shipped express, charges collect. Any excess will be refunded. C.O.D. shipments require a 20% deposit. If full remittance accompanies order deduct 2% discount. Send money order—certified check—new U. S. stamps. No C.O.D. to foreign countries.

ORDER TODAY QUANTITIES LIMITED QUICK SHIPMENTS ASSURED

EDISON 1/50TH H.P. UNIVERSAL MOTOR

Made by Edison Electric Co. for Dictaphone machines. Can be used on 110 volt D.C. or A.C. lives any frequency on A.C. Double shaft, 3/16th in. diam. Any speed obtainable with suitable rheostat. Size 9" x 4" high, x 5 1/2" wide overall. Shp. Wt. 8 1/2 lbs.

ITEM NO. 10
Your Price **\$2.25**

WESTERN ELECTRIC BREAST MIKE

A lightweight aircraft-type carbon microphone, with brass plate mounting. Can be adapted for home broadcast, casting or private communication systems. With cord and plug. Shp. Wt. 4 lbs. (Illustrated at right.)

ITEM NO. 14
Your Price **\$2.45**

Magnavox Anti-Noise Microphone. Also good for home broadcasting etc. With cord and plug. Shp. Wt. 2 lbs.

ITEM NO. 15
Your Price **\$1.80**



NEW FUEL PUMPS

Brown & Sharpe pumps. Brand new, never been used. Can be used for gasoline, oil, kerosene and other fuels. Not good for water. Takes standard thread 1/4" input and output pipes. Has 1/4" drive shaft. Measures 4 x 3 3/4 x 3 1/4" diam. overall. Shp. wt. 8 1/2 lbs.

ITEM NO. 24
Your Price **\$4.45**

U. S. NAVY BAUSCH & LOMB TELESCOPE

Precision-built for U. S. Navy use as finders on large calibre guns. CAMERA FANS—USE IT FOR CLOSE-UPS OF DISTANT PICTURES. Optical system comprises 7 lenses and erector and eyepiece draw tubes. Object lens 2" variable; eye lens 1 1/16" exit pupil 0.27 to 0.007". Angular field 190°. Power 3 to 10. erect image; cross hairs used. Net wt. 6 lbs. Original cost said to be over \$130. Shp. wt. 10 lbs.

ITEM NO. 25
Your Price **\$14.95**

GUARANTEED REBUILT VACUUM CLEANERS

All NATIONALLY-KNOWN makes—GUARANTEED FOR 6 MONTHS. All parts, no matter how slightly worn, are replaced with NEW ones—no supply new bags, new cords, brushes, handles, belts and other parts. Even the chassis itself is replated and polished. We've been selling these rebuilt machines since 1930; all our customers are satisfied, or money back. THERE'S NO GRIEF WITH THESE MACHINES!

EUREKA NO. 9—Straight suction. Fixed brush. Pistol grip handle. Switch in handle. Polished aluminum housing. 13-inch nozzle. Shp. wt. 20 lbs. List Price, \$52.20.

ITEM NO. 26
Your Price **\$10.48**

HAMILTON BEACH—Motor driven brush. Pistol grip handle. Polished aluminum housing. 12-inch nozzle. Switch in handle. Shp. wt. 20 lbs. List price, \$89.50.

ITEM NO. 27
Your Price **\$13.95**

HOOVER NO. 105—Motor driven brush. Foot control switch. Black enamel steel motor housing. 12-inch nozzle. Shp. wt. 24 lbs. List Price, \$63.50.

ITEM NO. 28
Your Price **\$13.95**



PREMIER DUPLEX—Motor driven brush. Pistol grip handle. Switch trigger in handle. Polished aluminum housing. 13-inch nozzle. Ball bearing motor. Shp. wt. 20 lbs. List Price, \$60.00.

ITEM NO. 29
Your Price **\$16.95**

ELECTROLUX NO. 11—Rational design. Cylinder type motor. Complete with all attachments. Foot control switch. Has 101 uses; cleans upholstery, walls, draperies, curtains, mattresses, etc. Shp. wt. 18 lbs. List Price, \$69.75.

ITEM NO. 30
Your Price **\$16.48**

HOOVER NO. 700—Agliator type cleaner. Pistol grip handle. Switch in handle. All high polished aluminum finish. Ball bearing motor. Shp. wt. 25 lbs. List Price, \$79.50.

ITEM NO. 31
Your Price **\$26.95**

PORTABLE TELEGRAPH AND BUZZER FIELD SETS

Made for military use by Western Electric. A wonderful buy if only for the parts it contains. Never been used. Good for code practicing, signal box, communications, etc. Contains 2-tone, high-frequency buzzer with platinum contacts, telegraph key, telephone switches, carbons, condensers, transformers, chokes, etc. A \$50 value easily. Complete in wooden case with diagrams and instructions. Shp. Wt. 12 lbs.

ITEM NO. 16
Your Price **\$5.45**

SPERRY GYROSCOPE LIQUID COMPASS

Made for U.S. Signal Corps; sensitive and accurate. Quick readings easily made from top; accurate readings of graduations through focusing magnifying lens on side of instrument. Complete with level sights and russet leather carrying case. Excellent for boats, boy scouts, campers, hikers, etc. A few turns of wire around its case makes it usable as a galvanometer. Shp. Wt. 3 lbs.

ITEM NO. 12
Your Price **\$1.85**



TELEGRAPHIC TAPE RECORDER

A wonderful buy! Apparatus makes a written record of code and similar messages on paper tape. An ideal machine for learning code or teaching code to groups. Radio men can easily adapt it to short-wave receivers for taking permanent records of code messages. Double men permits simultaneous recording of two messages. Pens are operated by battery and key while tape feeder is spring driven (hand wound). Case made of solid brass on heavy iron base. Completely reconditioned. (Less tape; easily obtained anywhere.) Original cost \$85.00. Shp. Wt. 20 lbs.

ITEM NO. 20
Your Price **\$19.95**

ANTI-CAPACITY SWITCHES

Made by Western Electric. Double throw switch with 12 terminals—equivalent in two double-throw switches. All contacts are of platinum plate. Original price \$3.50 each. Shp. Wt. 1 lb.

ITEM NO. 23
Your Price **\$1.55**



THE LATEST RADIO EQUIPMENT

(Continued from preceding page)

By holding the capacity portion of the condenser to a size of only 1 cubic inch, and enclosing that portion in a vacuum envelope, transmitter circuit efficiencies of 80%, with minimum harmonic radiation, may be realized due to elimination of stray capacities and high inherent inductance in tank circuits. Optimum Q is obtained. Available capacities: 6, 12, 25 and 50 mmf.

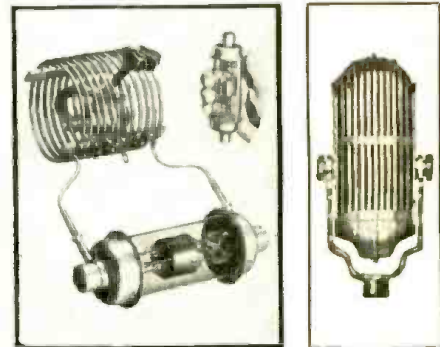

Upper-left—new "vacuum" condensers for transmitter. Upper-right—latest unidirectional microphone.

ONE-DIRECTION MICROPHONE (1723)

(American Microphone Co.)

TRY this experiment with the new non-directional microphone: face the mike toward the loudspeaker, of a sound system, about 4 feet away and adjust volume so that feedback is not excessive; now, turn the new type D9 dynamic microphone 180° so that the back now faces the loudspeaker—result, feedback ceases.

A bi-directional and a non-directional mike are combined in one unit so that the directional characteristics are additive and the anti-directional, subtractive. This results in reducing feedback by two-thirds. Unit may be used for close-talking due to the "modified velocity microphone" section which also reduces wind noises to a minimum.

Size, 2 1/4 x 2 1/2, 7 ins. high; weight, 2 1/2 lbs.; standard impedances: 50 and 10,000 ohms; to-order: 200 and 500 ohms.



Newest model 409A Multitester. (1722)

IMPROVED MULTITESTER (1722)

(Radio City Products Co.)

SUPERSEDING the model 409 Multitester is Radio City's new model 409A. This popular test instrument now boasts ranges as follows: Ohmmeter—0/100/7,500/75,000 ohms, and 7.5/10 megs.; Voltage (D.C.)—0/1,000 V.; Current (D.C.)—0/500 microamps., 0/5/50/500 milliamps., and 0/10 amps.; Decibels—-12 to +54 db. Sensitivity, 2,000 ohms/volt; accuracy is said to be within 2%, on long, multiple scales.

WE HAVE NO CATALOG. ORDER FROM THIS PAGE.

HUDSON SPECIALTIES - 40-R West B'way - N.Y.C.

IT'S EASY TO ORDER—CLIP COUPON—MAIL NOW

HUDSON SPECIALTIES CO., 40-R West Broadway, New York, N. Y. RC-239

I have circled below the numbers of the items I'm ordering. My full remittance of \$..... (Include shipping charges) is enclosed.

OR my deposit of \$..... is enclosed (20% required), ship order C.O.D. for balance. (New U.S. stamps, check or money order accepted.)

Circle Item No. wanted: 10 12 14 15 16 20 23 24 25 26 27 28 29 30 31

Name Address

City State

Send remittance by check, stamps or money order; register letter if you send cash or stamps.

BUILD THE "LUNCHBOX 5" BATTERY PORTABLE

(Continued from page 465)

panel edge and both sides, leaving a partition measuring 4-19/32 x 3-27/32 ins. The bent-down portion is placed toward the chassis side. Drill holes for gang condenser mounting as follows: one 1-11/16 ins. from side and 20/32-ins. from panel edge. Another 1-11/16 ins. from side and 2-20/32 ins. from panel edge. The third, 13/16-in. from side and 1-20/32 ins. from panel edge.

The sub-chassis, dimensions for which are given in Fig. 2, when completely assembled, mounts to the upper-left corner of the receiver panel (see photo) with 2 self-tapping screws. As coil mountings and shields vary, no dimensions are given; the layout can be completed by reference to the photos. The antenna coil and R.F. coil shields can be seen in one photo; the antenna coil being the smaller one.

WIRING

Having constructed and mounted all chassis parts, proceed by connecting all filaments in parallel and ground the negative "A" side (either side).

Wire-in the screen-grids of the R.F. and I.F. tubes, and place terminal strips, resistors and condensers per photos. The first two 0.05-mf. A.V.C. bypass condensers and the 0.1-meg. isolating resistor, are mounted under the antenna section of the gang and on the R.F. coil shield by a 3-lug terminal strip. This is necessary because of limited space. The oscillator padder mounts together with a 50,000-ohm resistor atop the oscillator coil can; and a terminal strip holds a 0.5 meg. audio grid-leak and volume control coupling condenser (fastened under the mounting nut atop the I.F. can, per one of the photos).

A 3-lug terminal strip is mounted in the upper-left-hand corner of the sub-chassis in one photo, and the two 100 mmf. mica condensers and the 50,000-ohm resistor used as A.V.C. filter are connected to it. In the upper-right-hand corner of the same photo are the 20 mf. audio bypass condenser and the 0.1-mf. audio coupling condenser. The latter is a flat, moulded-in-rubber type now on the market. On the left side of this photo is the flat, 0.5-mf. screen-grid bypass.

TELESCOPIC ANTENNA

The antenna was purchased as a standard 13-in., 6-section telescopic antenna. It was necessary to cut each section down to an overall length, when closed, of 9 1/2 ins. (extended, 45 ins.). A roll of solder on each section may be substituted for the die roll which is cut off when shortening the antenna.

A General Radio type banana plug was filed to fit the curved antenna and soldered securely about mid-way of the outside section. This plugs into a jack mounted to the receiver panel. A piece of hardrubber, formed so the antenna could clip into it on 3 sides, was cemented to the panel at the base of the antenna.

Binding posts mounted to the receiver panel facilitate ease of battery removal; and chassis likewise. It is only necessary to insulate 2 of these as "A-" and one side of the voice coil can be grounded. It was necessary to cut down the standard posts and also the bar knobs to clear the speaker panel.

ALIGNMENT

To align, connect an output meter to speaker binding posts and from a 260 kc. signal generator connect a lead through a 0.1-mf. condenser to the converter tube. Align, in order, the I.F.T.2 and I.F.T.1 trimmers.

Then, with a 1,500 kc. signal generator connected to the antenna input (be sure antenna is removed) through a 27 mmf. condenser, rock the gang, and align the oscillator and R.F. trimmers to the fixed antenna section. Using parts as described you should reach a maximum frequency of 1,850 kc. Next, turn the dial to 600 kc. and rock the gang while adjusting the oscillator for greatest gain.

With a 100 kc. signal, checked against a known broadcast frequency, calibrate the dial onto the receiver panel. Punch with a letter-and-number set, and after painting, fill-in with white ink. Fish-paper should be cemented to the underside of the receiver panel where the "B" battery terminals are and to the side of the "lunchbox" where the grid caps come close. The grid leads were soldered to the sides of the caps to make space and to prevent poor connection.

Drill one hole through each of the 2 carrying handle supports and through the case to take a large-headed 6/32 machine screw. This will prevent the handle accidentally pulling out. Case and panel are finished in black crackle paint.

The pleasures and advantages of the portable are numerous. For instance, it may be used on fishing trips, in canoes or boats, on hunting parties, beach parties or just sun bathing, and on picnics; at football games and other sports events you can hear as well as see, if the event is being broadcast; and at the lake cottage, trailer or in a parked car viewing important events that are broadcast, or for just plain romantic reasons its use helps save the car battery; and lastly, it provides very practical room-to-room radio reception without the bother of messy wires.

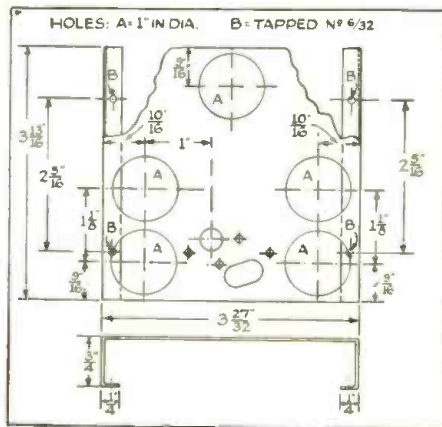

Fig. 2. Sub-chassis dimensions.

LIST OF PARTS

One lunchbox of standard size (available at any hardware or department store);
One Radiart 13-in. 6-section telescope-type antenna;

COILS

One Meissner iron-core antenna coil and shield, to match 27 mmf. capacity antenna and above gang (I constructed mine);
One Meissner R.F. coil and shield to match gang;
One Meissner oscillator coil for 260 kc. I.F.;
One Meissner I.F. transformer, for 260 kc., No. 1 (any 260 kc. auto-radio type should be satisfactory);
One Meissner I.F. transformer, for 260 kc., No. 2 (any 260 kc. auto-radio type should be satisfactory);

RESISTORS

One Centralab volume control (and switch),
(Continued on page 507)

Up to the minute with
New Added Features
at No Added Cost



MASTER TUBE TESTER

- * Tests All Receiving Tubes, including the new 1.5 Volt and 50 Volt series; the small loctal base types and the OZ4 and other gaseous rectifiers.
- * Separate Plate Tests on Diodes and Rectifiers.
- * Uses Approved Emission Circuit Constructed to RMA Load Requirements.
- * Ballast Tube Continuity Test
- * Neon Short Test.

The Triplet Tube Tester in the Master Case has always been one of the most popular tube testers ever placed on the market. Now comes Model 1212 with new added features bringing this famous tester right up to the minute but at

NO ADDED COST!

This model is installed in a metal case 7 3/4" x 6 5/8" x 4 1/2"—the last word in compact size and lightness for a high grade, thoroughly professional, thoroughly dependable tube tester. Ideal for field work. Tester has three-color GOOD-BAD scale, line voltage adjustment and is set by selector switches from tube charts. Up-to-date charts are provided to all registered owners as new tubes appear... Dealer Net Price \$22.00

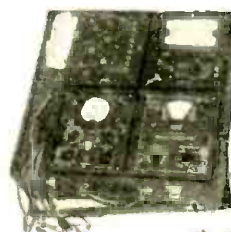

TRIPLET MASTER TESTERS

A series of co-related single unit testers; made in standard case size; the most economical method yet devised for completely equipping the all-around service shop with high quality instruments. Start your master test this popular tube tester.

See Your Jobber—Write for Catalog

THE TRIPLET ELECTRICAL INSTRUMENT CO.
162 Harmon Ave., Bluffton, Ohio

Please send me more information on—
 Model 1212

Name
Address
City State

MR. SERVICEMAN! 1939 IS YOUR YEAR



Let's Go - - Together!

MAIL THIS COUPON!

RADIO SERVICEMEN OF AMERICA, INC.
304 South Dearborn St., Chicago, Ill.

Gentlemen:
I hereby make application for membership in the
Radio Servicemen of America.

Name State

Home Address

City

Firm Name

Address

I am enclosing \$4.00 for Dues and Initiation.
(Nominal Local Chapter Dues not included.)

RC 239

RSA has pioneered and established these benefits for you. Join now — so you can get them: ★ Membership in the only Independent Servicemen's Organization in the Industry. ★ Advanced Service Courses for Members. ★ Technical advice and assistance for members asking it. ★ Recognition by and representation in the entire servicing business. ★ RSA is as important to you as your job or your business. Don't wait—send your application in **today!**

National Yearly Dues \$3.00
Initiation Fee - - \$1.00

RADIO SERVICEMEN OF AMERICA, INC.

Joe Marly, Jr., Exec. Secretary
304 S. Dearborn St., Chicago

"HQ-120-X" SHORTWAVE RECEIVER

(Continued from page 473)

the entire 31 to 0.54-mc. range of the receiver, because then, each wave-range (there are 6 of them) employing the proper

size tuning condenser for maximum efficiency, the inclusion of the broadcast band in no way affects the efficiency of the re-

ceiver at higher frequencies. The net result is akin to having a separate receiver for each wave range. (Cont on facing page)

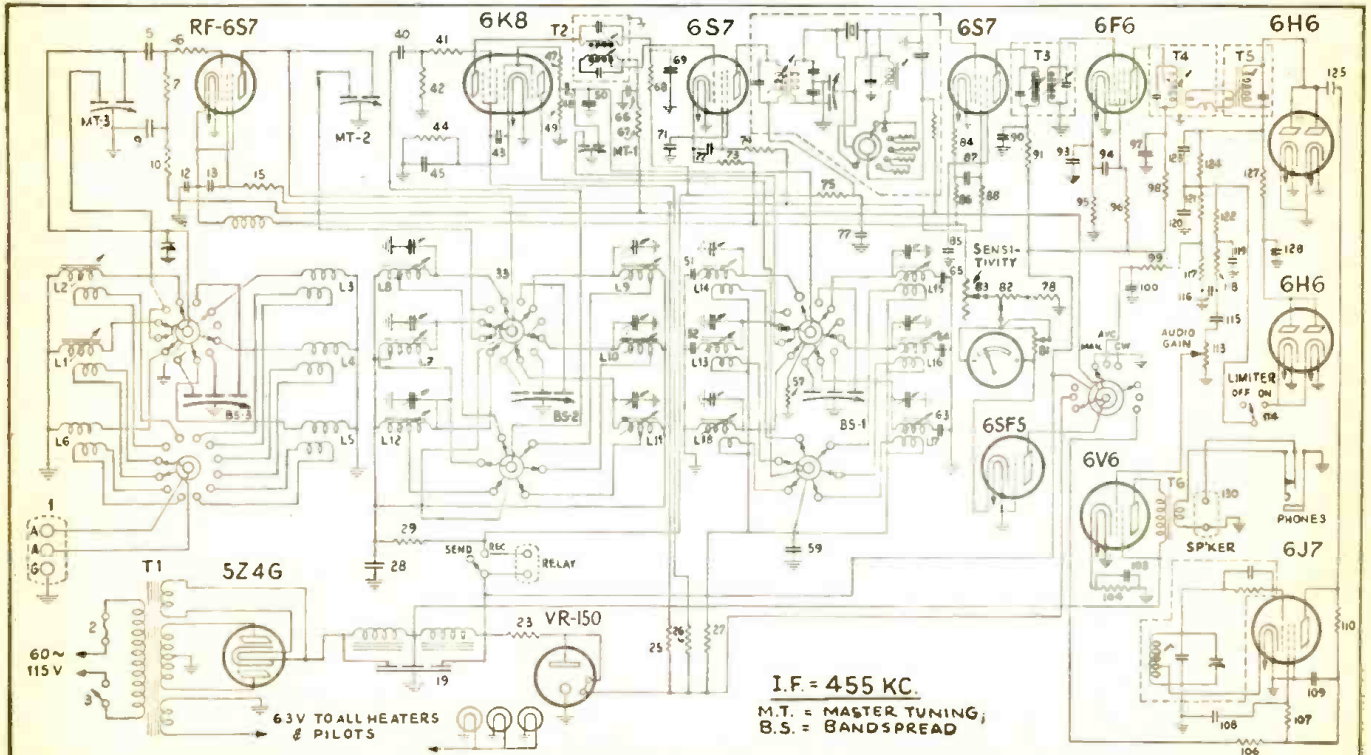

Fig. 1. Tube services (clockwise from upper-left): 6S7, 1st R.F.; 6K7, converter; 6S7, 1st I.F.; 6S7, 2nd I.F.; 6F6, 3rd I.F.; 6H6, 2nd-det.; 6H6, noise limiter; 6J7, beat oscillator; 6V6, A.F. amp.; 6S7S, meter control tube (V.T. V.M.); VR-150, voltage regulator; 5Z4G, rect. Selectivity switch is shown in "broad" position.

5-40-600 mmf.	98-2,000 ohms	44-230 ohms	52-300 mmf.	81-82-80 ohms	99-127-1 meg.	23-0.001-mf.
6-41-25 ohms	19-16.8-16 mf.	45-71-85-94-100-108-	57-10 ohms	83-10,000 ohms	103-40 mf.	125-10 mmf.
7-0.5-meg.	23-3,000 ohms	109-0.05-mf.	63-0.002-mf.	84-400 ohms	104-350 ohms	42-49-117-118-121-122-
9-12-13-43-59-66-69-72-	25-6,000 ohms	47-15 ohms	64-0.0015-mf.	86-300 ohms	107-110-0.1-meg.	124-50,000 ohms
77-87-90-97-0.02-mf.	26-7,000 ohms	48-50 mmf.	65-0.001-mf.	93-128-0.1-mf.	113-0.5-meg.	
10-67-106-10,000 ohms	27-5,000 ohms	50-5.5 mmf.	73-700 ohms	95-600 ohms	115-0.01-mf.	
15-29-68-74-75-88-91-	28-0.005-mf. mica	51-673 mmf.	78-50 ohms	96-50,000 ohms	116-119-120-100 mmf.	

Please Say That You Saw It in RADIO-CRAFT

(Continued from opposite page)

ANTENNA COMPENSATOR; "S" METER

The smaller condenser shown between the 2 large condenser gangs (see Fig. C) is the *antenna compensator*. Through the use of this control, the operator can obtain maximum efficiency, image rejection, sensitivity, and signal-to-noise ratio, with the particular type of antenna employed.

Another great problem in designing a communications-type shortwave receiver, is that of maintaining uniformity of the signal-strength meter readings throughout the tuning range of the receiver. Hammarlund engineers have treated the R.F. portion of the receiver in such a manner as to maintain constant gain in all of the amateur bands. This means that it will not require a stronger signal in the 20-meter band to read "S9" (maximum signal strength) than is required in the 80-meter band. Then too, the constant output level of the crystal filter further maintains the accuracy of the signal strength ("S") meter. This meter is calibrated in units from 1 to 9 and also up to 40 db. above S9. A very flexible vacuum-tube voltmeter circuit is employed with the "S" meter. This circuit has adjustments on the rear of the chassis so that corrections can be made to compensate for various line voltages which definitely affect the accuracy of the meter readings.

NOISE LIMITER; BAND-SPREAD

Automobile ignition interference and similar crackling disturbances are eliminated by a special *noise limiter* circuit, an automatic device which follows the level of the incoming signal. It has no controls on the front panel, save an on-off switch. Its use in no way affects the quality of the incoming signal.

By virtue of the special tuning condenser and dial arrangement, there is a spread of over 310 degrees in each amateur band. The bandspread dial has an arbitrary scale from 0 to 200. *There are 4 other scales which are calibrated directly in megacycles for each of the 4 amateur bands; 80 to 10*

meters, inclusive. This calibrated bandspread dial is exceptionally valuable in view of the recent Federal regulations regarding the monitoring of amateur stations. Calibration of the bandspread dial was made possible due to the excellent stability of the receiver.

VOLTAGE REGULATION

In order to obtain a high order of stability (besides careful design of the high-frequency circuits), a *controlled voltage power supply* for the high-frequency oscillator has been incorporated. This automatic voltage regulating power supply maintains constant voltage on both the high-frequency oscillator and the "S" meter tubes. Therefore, variations in line voltages affect neither the calibration of the receiver nor the accuracy of the "S" meter. The main tuning dial is, of course, calibrated in megacycles for the entire range of the receiver from 31 to 0.54-mc., or 9.7 to 555 meters.

In addition to the above-mentioned features the HQ-120-X has A.V.C.; beat oscillator; phone jack, and relay terminal connections.

The circuit arrangement needs little description. The diagram (Fig. 1) provides all the information necessary.

The receiver is housed in a black wrinkle finished cabinet and has a beautifully etched panel finished in dull black and aluminum. The panel, incidentally, forms no part in the mechanical set-up of the receiver. Since no critical components are supported by the panel, *any pressure that may be exerted on the panel will cause no detuning*. The 2 dials, as well as the "S" meter, are brilliantly illuminated with 3 individual lights.

This set covers all the important amateur, commercial, and shortwave broadcast bands, as well as the regular broadcast band, and has exceptional sensitivity. The ranges of the individual bands are (1) 31-18 mc.; (2) 18-10 mc.; (3) 10-5.7 mc.; (4) 5.7-3.2 mc.; (5) 3.2-1.32 mc.; (6) 1.32-0.54 mc.

This article has been prepared from data supplied by courtesy of Hammarlund Mfg. Co., Inc.

BUILD THE "LUNCHBOX 5" BATTERY PORTABLE

(Continued from page 505)

- 0.3-meg. (Any standard make with grid-circuit curve may be used.);
- One I.R.C. resistor, 450 ohms, 1/2-W.;
- One I.R.C. resistor, 6,000 ohms, 1/2-W.;
- One I.R.C. resistor, 20,000 ohms, 1/2-W.;
- One I.R.C. resistor, 50,000 ohms, 1/2-W.;
- Two I.R.C. resistors, 0.1-meg., 1/2-W.;
- One I.R.C. resistor, 0.25-meg., 1/2-W.;
- Two I.R.C. resistors, 0.5-meg., 1/2-W.;
- One I.R.C. resistor, 1 meg., 1/2-W.;

CONDENSERS

- One American Steel Package midget-type gang T.R.F. condenser, 350 mmf. per section, counterclockwise rotation, trimmers on short end;
- One Micamold variable oscillator padder, 600 to 1,000 mmf. (order by specs.);
- One Cornell-Dubilier condenser, 0.01-mf., 100 V.;
- Two Cornell-Dubilier condensers, 0.05-mf., 100 V.;
- One Sprague flat (auto-radio type) condenser, 0.5-mf., 100 V.;
- One Aerovox flat condenser, moulded in rubber, 0.1-mf., 400 V.;
- One Cornell-Dubilier condenser, 0.006-mf., 400 V.;
- One Cornell-Dubilier condenser, 0.05-mf., 400 V., C1;
- One Micamold mica condenser, 250 mmf.;
- Two Micamold mica condensers, 100 mmf., C2, C3;

- One Mallory or Magnavox small electrolytic condenser, fabricated plate (Mallanode) type, 20 mf., 25 V.;

TUBES

- Two Sylvania type 1N5G tubes;
- One Sylvania type 1A7G tube;
- One Sylvania type 1A5G tube;
- One Sylvania type 1H5G tube;

MISCELLANEOUS

- Five Meissner bakelite press-fit-type sockets, octal base;
- One Oxford-Tartake Co. 3 1/2-in. P.-M. dynamic speaker, 3-ohm voice coil (order by specs.);
- One Cinch 6-point terminal strip;
- Three Cinch 3-point terminal strips;
- Two Eby small bar knobs (cut down to fit);
- Four Eby binding posts (cut down to fit);
- One General Radio type banana jack and plug;
- One Magnavox output transformer, 25,000 to 3 ohms, 1/2- x 5/8-in. stack (order by specifications);
- One standard, No. 6 drycell (or preferably, with 4-cell—long-life—construction);
- Two Burgess "B" batteries, type 230BP;
- One length of .030 sheet steel sufficient for panels, partition, sub-chassis (see article for dimensions), obtainable at any steel warehouse or tin shop;
- One assortment of hardware, fish-paper, flexible and hookup wire, and solder lugs.

Please Say That You Saw It in RADIO-CRAFT

Amateurs! Servicemen!

SAVE MONEY

Send for NEW
WARDS
1939
CATALOG
Free!

EVERYTHING
SOLD ON
TIME
PAYMENTS!



RADIO CATALOG

64 Pages of the Finest Nationally Advertised Amateur Equipment, Sound Systems, Servicemen's Equipment, all at low prices that only Wards tremendous facilities make possible—and everything offered on Wards liberal Time Payment Plan. Take the first step toward saving money today—mail coupon at once for Wards 1939 Radio Catalog.

MONTGOMERY WARD

"9 GREAT MAIL ORDER HOUSES • 580 RETAIL STORES"

FREE!
MAIL THIS COUPON
NOW!

Montgomery Ward & Co.
Dept. RZ-23
Chicago, U. S. A.
Please rush me Wards
1939 Radio Catalog

Name.....

Address.....

City..... State.....

PHOTRIX UNIVERSAL PHOTOMETER



Light measuring instruments of unequalled sensitivity down to 1/1000 ft.-candle per 1/16" division.

Mod. A. 4 ranges **\$57.00**

Mod. B. 3 ranges **\$37.50**

Special models with multiple cells to order.

Also **ELECTROCELL Photo-Elements**
Great variety of sizes and shapes
DR. F. LOEWENBERG, 10 E. 40th St., NEW YORK

DO NOT FAIL

to read the important announcement which appears on page 452 of this issue. It is important news to everyone who is in the radio business.

Radio Men Find This Book Handy

FORMULAS AND RECIPES
For the Practical Man

50¢ POSTPAID

Here Is the Contents of the Book

1. Adhesives; Glues, Cements, Gums, Mucilages, Lubricants, 2. Cleansing, Stain Removers, Fat Removers, Bleaches, Cleaning Fluids, 3. Metal Craft: Coloring, Oxidizing, Plating, Repairing, Welding, Polishes, Alloys, Solders, Amalgams, 4. Paints: Colors, Stains, Varnishes, Enamels, Luminous Paint, Washable Paint, 5. Glass: Removing, Waterproofing, Fireproofing, 6. Glass Working: Cutting, Drilling, Boring, Bending, Blowing, Etching, Engraving, Frosting, Silvering, etc. 6. Wood-craft: Fillers, Fireproofing, Acid-proofing, Waterproofing, Furniture Finishes, Finishes, etc. 7. Inks: Recipes, Erasers, Ink Stain Removers, Special Inks, Colored, Indelible, Sympathetic, Invisible, Hectograph, 8. Photography: Developers, Emulsions, Filters, Sensitizing, Toning, Printing, Photographic Paper, Blueprint Paper, 9. Antidotes for Poisons, Remedies for Burns and Scalds, Disinfectants, First-Aid in Accidents, Emergency Remedies, Home Remedies, 10. Preparation, Manipulation, Handling, Mixing, Measuring, Weighing, Filtering, Straining Solutions; List of Technical Substances; Emulsifying; Use of Hydrometer, Use of Thermometer; Tables of Weights and Measures, Decimal Systems, Useful Tables.

TECHNIFAX, Division RC-239
560 W. Washington Blvd., Chicago, Illinois

TECHNIFAX, Division RC-239
560 W. Washington Blvd., Chicago, Illinois

Gentlemen: Enclosed please find 50¢ check, money order, coin or unused U.S. stamps accepted for value and the POSTAGE PREPAID. One copy of FORMULAS AND RECIPES for the Practical Man.

Name

Address

City

State

FREE TRIAL OFFER

NEW REMINGTON NOISELESS PORTABLE!
AS LITTLE AS



10¢ A DAY

Famous Remington Noiseless Portable that speaks in a whisper. Day as little as 10¢ a day.

Guaranteed by the factory. Standard keyboard. Automatic ribbon reverse. Variable line spacer and all the conveniences of the finest portable ever built. PLUS the NOISELESS feature. Act now. Send coupon TODAY for details.

You don't RISK a Penny

We send you Remington Noiseless Portable for 10 days' free trial. If not satisfied, send it back. We pay all shipping charges.

Typing Course and Carrying Case

You will receive FREE a complete simplified home course in Touch Typing, a handsome sturdy carrying case is included. No obligation. Mail coupon for full details—NOW.

Remington Rand, Inc., Dept. 189-2,
465 Washington St., Buffalo, N.Y.

Tell me, without obligation, how to get a Free Trial of a new Remington Noiseless Portable, including Carrying Case and Free Typing Course for as little as 10¢ a day. Send Catalogue.

Name

Address

City

State

GUARANTEED 6 MONTHS

SYLVANIA

SET-TESTED RADIO TUBES

RADIO TRADE DIGEST

RMA REORGANIZES ENGINEERING WORK

(Continued from page 479)

meeting or through their Chairmen. Such proposals will be submitted by letter to the members of the Committees concerned and to the RMA membership to obtain written comments or criticism. If a meeting of any Committee is necessary to discuss these proposals, it will be called. When the Standards Committee approves by a vote of 2/3 of those present, a proposal shall become, according to the judgment of the Committee, either an:

- (A) **R.M.A. Standard:**—Definite Standards may include Definitions, Nomenclature, Symbols; Testing Methods and Apparatus; Performance Ratings, Capacities and Limits; Manufacturing Dimensions and Tolerances; Safety Provision, Or.
- (B) **R.M.A. Recommended Practice:**—Any suggestion or practice which, at the time of consideration, may be thought unsuitable for adoption as an R.M.A. Standard, but which is desirable to recommend as uniform practice, may be approved as an R.M.A. Recommended Practice.

Standards and Recommended Practices may be revised, amended, or rescinded by the same procedure.

Publications

All R.M.A. Standards and Recommended Practices shall be published in the **R.M.A. Standards and Engineering Information**. Any technical information of sufficient value to warrant publication, but which is not a subject for standardization, may be included in the section entitled "Engineering Information". Proposed Standardization may be published for the information of the members of the Association at the discretion of the Assistant Director.

U. S. TELEVISION SHOWS TO BEAT BRITAIN'S BEST, SAYS SAGALL

(Continued from page 479)

up, a mass (theater) entertainment project, possibly a limited-range advertising service, & business communications. These are in addition to the obvious use of home entertainment.

Scophony's first job in U.S. will be to raise funds to get the American co. going. This will not be a "promotion," Sagall says, adding, "The firm's name means too much for us to cheapen it by dubious financing."

THE RSA MONTHLY BUGLE

(Continued from page 480)

attended, Joe Marty, Jr., Executive Sec. of the RSA, discussed the progress of the RSA and outlined future plans of the national organization. Local charters were presented to the Flint (Mich.) Chapter, Detroit (Mich.) Chapter, and Pontiac (Mich.) Chapter.

A concentrated membership drive, under the direction of Harry Miller, is underway in Newark, N. J. A very important point in the program is the insertion of advertisements in local newspapers in each county of the state. These ads stress the necessity of good radio service and particularly the kind extended by RSA members.

Boston (Mass.) Chapter heard Director Saunders, of the 20th District of RSA, explain the workings of the oscilloscope. Meetings are under the direction of William Wells, Chairman, and Hyman Leve, Chairman, Program Committee. Ingvor Paulsen, Sec., is still on duty after all these years.

Orden (Utah) Chapter has embarked upon a publicity program to acquaint the public with the value of good radio servicing.

NEW CHAPTERS—The RSA has affiliated during the past several weeks, the Lehigh Valley Radio Service Association of Allentown, Penna. T. W. Reichard, Pres., J. A. Muthart, Treas., H. H. Fillman, Sec.; and Hartford Institute of Radio Technicians, Gerald Miller, Chairman; James H. Smith, Jr., Sec., Kenneth G. Anderson, Treas. These are two of the oldest established local associations in the country.

OPPORTUNITY AD-LETS

Advertisements in this section cost five cents a word for each insertion. Name, address and initials must be included at the above rate. Cash should accompany all classified advertisements unless placed by an accredited advertising agency. No advertisement for less than ten words accepted. Ten percent discount for six issues, twenty percent for twelve issues. Objectionable or misleading advertisements not accepted. Advertisements for March, 1939, issue must reach us not later than January 5th.

Radio-Craft • 99 Hudson St. • New York, N. Y.

ADVERTISING AGENCIES

850 PROFITABLE MEDIUMS FOR CLASSIFIED ADVERTISING—A new published 24-page booklet, "Publication Directory of Classified Advertising Markets," lists over 850 magazines (with addresses) according to industries, trades and services covered. Price \$1.00 postpaid. Continental Advertising, 15 Park Row, New York, N. Y.

BOOKS AND MAGAZINES

WE HAVE A FEW HUNDRED RADIO ENCYCLOPEDIAS, by S. Gernsback, second edition, originally sold at \$9.98. Book has 352 pages, weight 3 lbs., size 9 x 12 inches. Red Morocco—keratin flexible binding. Send \$2.49 in stamps, cash or money order and book will be forwarded express collect, Technifax, 558 W. Washington Blvd., Chicago, Illinois.

BUSINESS OPPORTUNITIES

RELIABLE PERSON IN EACH TOWN FOR OWN ADVERTISING—distributing agency. No selling. Good paying business. Dawson's Advertising, Cape Girardeau, MISSOURI.

CAMERAS & SUPPLIES

AMBERTINT 16MM. CAMERA FILM, \$1.85 FOR 100 feet, including machine processing, Daylight loading Weston Eight, Nonhalation. Two rolls \$3.50. Order now. Hollywood Studios, Southgate, Calif.

JOIN THE THOUSANDS OF CANDID CAMERA FANS—a genuine filmcam equipped with Wollensak 50 mm. lens, speed shutter and accurate "spy glass" view finder. Fixed focus assures sharp pictures. 1 1/2 x 1 1/2 inches. Enlarges with clarity up to 8 x 10 inches. Has special compartment to carry extra film roll and tripod socket for mounting. Uses economical Kodak 127 or Agfa A8 film in color or black and white—takes 16 pictures. Housing built of unbreakable bakelite composition. Camera weighs only 9 ounces; measures 7" long by 3" high by 2" wide. Easy to operate and inexpensive to use. Shipped postpaid anywhere in U.S.A. with guarantee of safe delivery—\$3.98. Hudson Specialties Company, 48RC West Broadway, New York, N. Y.

COINS AND STAMPS

IN GREAT DEMAND! KING EDWARD VIII SET, complete 25c, with price lists. National Parks Stamp Shop, Gloucester, Mass.

STAMP COLLECTORS—INTRODUCTORY OFFERING—103 stamps including scarce Bi-colored, Diamond and Triangular shaped commemoratives—10c. Approval. Friendly Philatelists, Box No. 1281R, Philadelphia, Penna.

FOR INVENTORS

CASH FOR UNPATENTED IDEAS. STAMP FOR PAPER, Healers, 33, Ball, 9111 J. Pleasant, Chicago, Ill.

INSTRUCTION

RADIO ENGINEERING, BROADCASTING, AVIATION and police radio, servicing, marine and Morse telegraphy taught thoroughly. All expenses low. Catalog free. Dodge's Institute, Pine St., Valparaiso, Ind.

MISCELLANEOUS

MEXICAN DIVORCES: NO PUBLICITY. AMERICAN ATTORNEY, Box 1750, El Paso, Texas.

PYRO PANTAGRAPH—THIS ELECTRICAL OUTFIT burns deserts permanently on leather, wood, cork, bakelite, etc. Simply plug pyro electric pencil into any 110 v. A.C. or D.C. line and it is ready to use. Reduce or enlarge any design with special pantagraph included. Complete kit and instructions, \$2.75. (Add postage for shipping 2 lbs.) Wellworth Trading Company, 560 H West Washington Street, Chicago, Illinois.

MONUMENTS & TOMBSTONES

GENUINE MARBLE, GRANITE, FREIGHT PAID, Catalog free. \$11 up. United States Marble & Granite Co., A 27, Ocala, Fla.

OFFICE SUPPLIES

ENVELOPES—1000—6 3/4's \$1.75; 1000—10's—\$2.85; 100 sheets carbon paper \$1.50; equivalent "Everything for the office," Lathin, 603 Main, Evanston, Illinois.

PHOTOGRAPHY

ROLLS DEVELOPED—3 LARIAPRINTS (ENLARGEMENTS) 25¢ or 8 regular prints 25¢, Star Photo, New Britain, Connecticut.

RADIO

SOMETHING BRAND NEW—UNIVERSAL PLUG-IN TYPE—Automatic Unit ready to mount. One Dollar. E. D. Heller, 2571 Webster Avenue, New York, N. Y.

AMAZING POCKET RADIO, PLUG IN LIGHT SOCKET, \$2.50 guaranteed. Sample radio, Cse. Engel Radio, Route 8, Box 1626, Phoenix, Arizona.

SALARIED POSITIONS

OUR SYSTEM OF SEARCHING FOR SALARIED POSITIONS, hiding your identity, increases your salary commensurate with training and experience, and with definite results. Write, Executive's Promotion Service, 300 B Street, S.E., Washington, D. C.

SONG POEM WRITERS

WANTED ORIGINAL POEMS, SONGS, FOR IMMEDIATE CONSIDERATION. Send poems to Columbian Music Publishers, Ltd., Dept. 1469, Toronto, Can.

SONGWRITERS! MELODY FOR WORDS \$1.00, Littig, 215 Mason Theatre, Los Angeles, California.

Attractive
MODERN DESK LAMP
 Absolutely **FREE**
 READ THE DETAILS

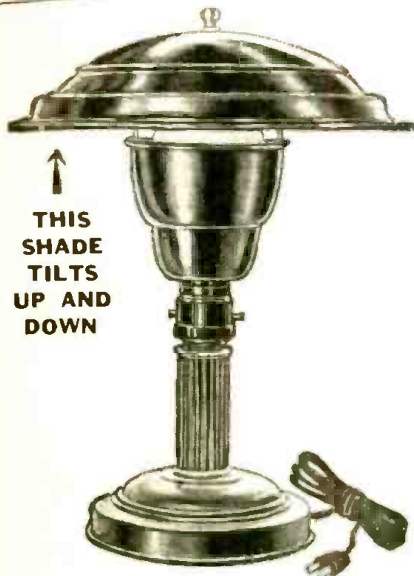

JUST THINK OF IT—you can get absolutely FREE, the beautiful desk lamp shown at the top. This attractive desk lamp is suitable for home, desk, den, office, laboratory, studio or workshop. It is sent to you by the publishers with their compliments for a one-year subscription to RADIO-CRAFT. Look at the many fine features which this handsome desk lamp has. Read the list below.

HERE ARE THE LAMP FEATURES!

- ⊗ Constructed of metal with attractive bronze finish.
- ⊗ Scientifically constructed to give glareless, diffused light.
- ⊗ Helmet-type shade can be tilted to any convenient angle.
- ⊗ Stands 13" high and has 10" metal shade.
- ⊗ 5-foot rubber insulated cord and plug.
- ⊗ Constructed to last for many years.

Clip Coupon Today—and Mail!

Send your subscription today to RADIO-CRAFT for One Year (12 issues) and receive absolutely FREE one of these truly remarkable desk lamps. New subscribers are accepted or you may extend your present subscription another twelve months under this offer. Mail your remittance of \$2.50 (Plus 25c for shipping charges on lamp) to the publishers of RADIO-CRAFT. (Canada and foreign \$3.25.) You will promptly receive your FREE DESK LAMP by return mail. Use the coupon below to order your subscription.

RADIO-CRAFT

99 Hudson Street NEW YORK, N. Y.

RADIO-CRAFT
 99 HUDSON STREET, NEW YORK, N. Y.

Gentlemen: Enclosed you will find my remittance of \$2.50 for which enter my subscription to RADIO-CRAFT for One Year (12 issues). Send me promptly my FREE DESK LAMP. (Canada and foreign \$3.25.) You will promptly receive your FREE DESK LAMP by return mail. Use the coupon below to order your subscription.

NEW SUBSCRIBER
 EXTEND PRESENT SUBSCRIPTION

Name

Address

City State

(Send remittance by check, money order or unused U. S. Postage stamps. Register letter if you send cash or stamps.)

RC-239

RADIO TRADE DIGEST

OFF THE PRESS

(Continued from page 480)

TUBE CHARTS. FORM ACT 7138. Precision Apparatus Co., 821 East New York Ave., Brooklyn, N.Y. Free to owners of Electronimeters Models 500, 500A, 600 & 700.

REPLACEMENT CHARTS. Pauley-James Corp., 4619 Ravenswood Ave., Chicago, Ill. Lists mfrs. synch & non-synch units. Free on request.

PERIODICALS

OHMITE NEWS. Ohmite Mfg. Co., Chi., Ill.

SPOKANE RADIO CO., INC., Spokane, Wash.

THE BULLETIN. Associated Radio Technicians of B.C., Vancouver, B.C. Special 10th Anniversary Number.

BROADCAST MERCHANDISING. National Broadcasting Co., N.Y.C.

RADIOGRAM. Scott Wholesale Radio Co., Long Beach, Calif.

SNOOPS & SCOOPS

(Continued from page 481)

to advertised claims . . . And the FTC further says that Superior Instruments Co.'s advertising has been "false and/or misleading" . . .

4 new tubes, being used in new sets, are now ready for Servicemen under RCA Radiotron, RCA Victor, & Cunningham brands; all are metal tubes with interlead shielding, & the control-grid lead brought out through the base . . . Same co. also has new phono needle to give higher fidelity, less scratch, longer life & less record wear . . .

Sidelines! Stewart-Warner entered the electric range field when it introduced its 1939 refrigerator line . . . G-E introduced 4 new electric clocks & a new 2-slice automatic toaster of the "pop-up" type . . . Ampro Corp., of Chi., has just become exclusive sales outlet for Gumbiner Synco-Sound 16mm talkie camera; too costly for homes, it is swell for police depts., schools, talent tests, etc. . . . That G-E electric blanket has been given Underwriters approval . . .

General Household Utilities Co. is rumored ready to shelve its radio plant—though radio was 65.3% of its total business!!!! The plant is capable of turning out 5,000 sets daily . . . Jobbers can now get Triad series GT Bantam tubes in 7 types on immediate delivery—even if their press agent does spell it "Traid" . . .

Looks like a leading European radio mfr. may recover over \$100,000 out of which they might have been gypped—and if they do, they'll give credit to RTD . . . We can't tell their name yet; it might gun the works . . . Pauley-James Corp. now makes its Vibrapower autoradio vibrators in synchronous as well as non-synch models.

RCA has 5 new 5-tube "Little Nipper" superhets., priced from \$9.95 to \$17.95 . . . Ward-Leonard now provides molded bakelite "snap-on" covers for its midjet relays when panel mounting is desired . . .

(Continued on following page)

Please Say That You Saw It in RADIO-CRAFT

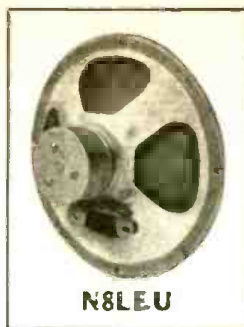

**NEW
 LOW
 PRICED
 NOKOILS**

Equal in construction and performance to the ELU Electro Dynamic Speakers.

These new NOKOIL Units are in a class by themselves.

7½ oz. RING TYPE
**MAGNET—SEAMLESS CONE—
 RUST PROOF—DUST PROOF.**

Furnished with either universal or line transformer.

Write for literature and prices.
 Wright-DeCoster Distributors are always anxious to cooperate.

WRIGHT-DeCOSTER, INC.

2251 University Ave., St. Paul, Minn.
 Export Dept.: M. Simons & Son Co., New York.
 Cable Address: "Simontrice"
 Canadian Representatives:
 Wm. F. Kelly Co., 1207 Bay St., Toronto, Ont.
 Taylor & Pearson, Ltd., Edmonton, Alta.

Those Who Know Speaker
 Quality Demand **WRIGHT-DeCOSTER**



RADIO INTERFERENCE FILTERS
 Reg. U.S. Pat. Off.

grand new money makers

Every service call you make is a chance to increase your profit-making opportunities by selling a C-D "Quietone" radio interference filter. Here's an item every set owner can use. And squarely behind this filter—is C-D's pledge of performance—a guarantee that dates back 29 years. Investigate the profit possibilities of "Quietone" today! The effectiveness of eliminating radio interference, caused by household appliances of all types, with C-D "Quietone," available at your local jobber. Or write direct for Catalog No. 166A.

**CORNELL-DUBILIER
 ELECTRIC CORPORATION**
 1014 Hamilton Blvd., So. Plainfield, N. J.
 Cable Address: "CORDU"

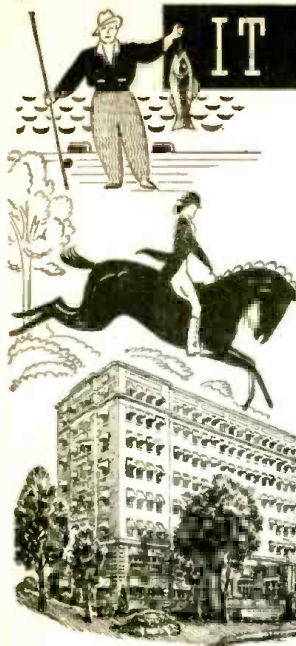

IT PAYS TO PLAY..

HOT SPRINGS NATIONAL PARK · ARKANSAS

Add years to your life by spending some time regularly in healthful exercise and toning up the system. Enjoy the refreshing mountain climate and all forms of sport and recreation. Benefit from bathing in the famous medicinal waters of the 47 U. S. Government supervised Hot Springs.

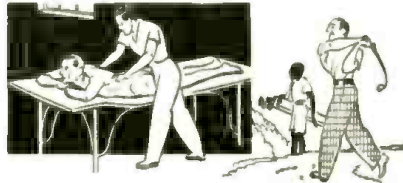

MAJESTIC HOTEL, APARTMENTS & BATHS

Stay at the new, modern Eastman Hotel! Enjoy the quiet of its vast private park - and the convenience of its ideal location! 500 large, comfortable rooms, -from \$2.50.

EASTMAN HOTEL AND BATHS

Write for descriptive literature.

J. A. SAEGER,
Manager

Stop at the Majestic Hotel for fine accommodations - single rooms, with or without bath, and beautifully furnished 2, 3 or 4 room apartments. Government-supervised bath house in connection. Rates moderate. from \$1.50...Two restaurants.

R. E. McEACHIN Manager



SOUTHWEST HOTELS, Inc. H. GRADY MANNING, Pres.

RADIO TRADE DIGEST

(Continued from preceding page)

Latest addition to WOR's setup is RCA facsimile transmitter & receivers; they had Finch already. . . WLBZ, Bangor, Me., has become the 161st, & WRDO, Augusta, Me., the 162nd link in the NBC net.

Dope from the RMA:— Although France has established quotas for American radio imports, only tubes sell out; French are admitting more U.S. sets & parts than market can absorb. . . Best thing for U.S. that RMA has done yet is supplying programs of U.S. shortwave best stations to Latin-American & European newspapers; Com. E. F. McDonald, Jr., of Chi., gets credit for the idea. . . Now the official RMA insignia can be used only on products that have Underwriters okay; but members can use it on their stationery, ads, sales literature, etc., irregardless.

PERSONAL

(Continued from page 481)

GARDNER, to the board of G-E. Mr. Gardner resigned his directorate after 43 years' service.

GEORGE SILVERSTONE, veteran radio man, has become General Sales Manager of the R. Graf Optical Co., lens mfrs. of Chicago.

TRADE WAR WITH DUTCH OVER ARGENTINE MARKET

(Continued from page 482)

for Government support with reference both to the proposed preferential tariff for radio tubes from Holland & the reciprocal trade agreement between the Argentine & Holland. Ratification of the latter was blocked at the last session of the Argentine Congress & the next regular session of the Congress is not scheduled until May.

Parts mfrs. as well as those making receiving sets and tubes, are affected by the Philips inroads in Argentina, one of the largest radio markets in Latin-America. There are reports that the success in Argentina by the Philips company will be followed by similar trade invasions elsewhere in South and Central America.

The Philips organization has bought the control of local factories in Buenos Aires but their output is not sufficient to supply either the normal tube or receiving set demands of the Argentine market.

\$'s & No.'s Dept.

(Continued from page 482)

dened on 1st pf. for Oct. 1 to Dec. 31: \$1.25 for "B" pf. in same period; and 20c on Common, ditto.

NBC UP, for Oct. '38, billings were \$3,773,964, or 13% over Oct. '37; 26.7% over Sept. '38. Biz for first 10 mo. of '38 exceeded 33 1/2 million, or 6 1/2% over same period of '37.

RADIO BIZ OFF, excise tax collections for Sept. '38 being \$345,431, or 45% below same mo. in '37. First 9 mo. of '38 collections were 36% below same period in '37.

RECENT F.C.C. RULINGS ON "WIRELESS" DEVICES

(Continued from page 501)

accomplish the desired purpose.

(b) That the best engineering principles shall be utilized in the generation of radio frequency currents so as to guard against interference to established radio services, particularly on the fundamental and harmonic frequencies.

(c) That in any event the total electromagnetic field produced at any point a distance of

$$\frac{157,000}{f \text{ (kc.)}} \text{ ft. } \left\{ \frac{\lambda}{2\pi} \right\}$$

from the apparatus shall not exceed 15 microvolts per meter.

(d) That the apparatus shall conform

to such engineering standards as may from time to time be promulgated by the Commission.

Rule 25.03. The provisions of Rules 25.01 and 25.02 shall not be construed to apply to any apparatus which causes interference to radio reception.

Rule 25.04. Upon request, the Commission will inspect and test any apparatus described in Rule 25.01 and 25.02, and on the basis of such inspection and test, formulate and publish findings as to whether such apparatus does or does not comply with the above conditions, and issue a certificate specifying conditions of operation to the party making such request.

CASH IN ON YOUR SPARE TIME!

300 WAYS TO MAKE MONEY

ONLY
25c
Per Copy



68
PAGES

BRAND
NEW BOOK
40,000 WORDS
in TEXT!

SOLD ON A
MONEY-BACK
GUARANTEE!

In "CASH IN" you get ALL the real money-makers - dozens of profitable tested mail order plans, confidential business secrets, dozens of practical tested formulas, successful tested schemes - actual experiences of men who have started on a shoestring - with less than \$10 capital.

Buyers of This Book Tell Us—

"Biggest value I've yet to see. Book is worth at least a dollar." S. HUDA, B'klyn, N. Y.

"Your book is as good if not better than others selling at \$1.00."

GEORGE BRUNET, Montreal, Can.

"CASH IN is the best value I have yet to see in the mail order field."

LAWRENCE FOX, Brooklyn, N. Y.

"CASH IN" contains only tested ideas covering every type of full- or spare-time enterprise - it's a "masterpiece" in business ventures.

25 CENTS per copy. Sent POSTPAID anywhere upon receipt of 25 cents U.S. stamps or coin.

NATIONAL PLANS INSTITUTE

246-R FIFTH AVENUE NEW YORK, N. Y.

Please Say That You Saw It in RADIO-CRAFT

SERVICING QUESTIONS & ANSWERS

(Continued from page 483)

P. S. By the way, the I.F. coil which I disconnected is the one to which the grid of the 2A6 tube connects.

(A.) In the receiver in question, the volume control is the diode load resistor. The "high" side of the control is connected to the secondary return of the second I.F. transformer and the "low" side of the control is connected to the cathode of the 2A6 tube. The arm or center contact of the control is connected to the control-grid of the 2A6 through a blocking condenser. A 2-megohm carbon resistor is in the control-grid circuit of the 2A6.

You state that the grid of the 2A6 is now in the I.F. transformer circuit. Revise your connections as stated above. An error was probably made when you replaced connections to the I.F. transformer.

MOMENTARY BLARE WHEN SET SHUTS OFF

(113) Lester Rinehart, Jonesboro, Ill.

(Q.) I have an Atwater Kent model 70 "Q" chassis battery set to service which is giving me a lot of headaches.

When the set is turned on it runs good and goes right along that way, but when I turn it off with the filament switch it bursts out exceedingly loud as the switch is turned off, then it goes off. I can turn the volume all the way off and switch the Local-Distance switch to Local (where I cannot possibly hear the station), and when I turn off the filament switch the station signal will burst out just for a flash, then fade

away; sometimes with a peculiar noise which sounds similar to a tube (circuit) in oscillation. I have put the voltmeter across the filaments and they go off normally when the set is turned off. I have put the voltmeter from the plates of the tubes to chassis and the voltage takes a dip when the set is turned off and the milliamp. reading rises. The "milliamps." double themselves in the plates of the 71A's but I figured this normal due to the strong signal which takes place. I have put on new "B" and "C" batteries and all tubes check good.

I have put on new switches of first one make, then a second, and this didn't help. About 5 months ago I installed a new, exact-duplicate volume control on the set and it checks good yet. I have substituted all condensers in the set, one at a time, and this didn't help. In fact, everything checks-out with the diagram.

When I use a shorter piece of wire for an aerial the trouble isn't as bad. When I take the aerial off and pull the volume wide open to pick up the station and then turn the set off the "burst out" is hardly noticeable. If I am not tuned to a station a loud hiss will appear when it is turned off. It seems that everything points to the R.F. stages. This set has been left set for 3 months on old batteries and there is some trace of corrosion in the set. I tried to clean out all I could see.

The set should normally make a "plop" in the speaker, when it is turned off, instead of this sudden burst-out of signal for just an instant. Please let me know as soon as you can what you think the trouble is.

(A.) The condition you are experiencing with an Atwater Kent model 70 Q-2 receiver, in which volume and plate current rise when the receiver is switched off, is abnormal in one instance and normal in the other.

Due to the fact that the ground leg of the screen-grid voltage control is opened when the filament switch is turned off, plate current will rise momentarily since the voltage impressed upon the screen-grid rises. In the case of the output tubes, the bias voltage is removed when the filament switch is opened, and since the 71-A tube filaments require a second or two to cool, there is a moment or two when the tubes operate without bias voltage, which in turn increases the plate current.

We advise that the filament switch and detector grid leak (2 megohms) be replaced. An original switch is probably best if this can be obtained.

Secure a double-pole double-throw switch with a long shaft.

Feature Articles in the February, 1939, Issue of "Radio & Television"

- World-Wide Digest of Radio Circuits.
- "Fips" Returns!—Hugo Gernsback.
- A 1-Tube Watch-Charms Receiver—L. S. Hoover.
- How to Break into Ham Radio—C. Walter Palmer.
- Television "Sound Channel" Receiver—H. Townsend.
- De Luxe Desk-Type Transmitter—Alvin Abrams, W2DTT.
- "Economy-3" Battery Receiver Using 1.4 V. Tubes—Harry D. Hooton, W8KPX.
- 1-Meter Receiver Using Ordinary Tubes.
- Roster "Newly-Licensed" Hams.
- Largest Accurate List "World S-W Stations."

The New **1939**
RADOLEK
NOW!

Get your free copy!

Everything in radio in this big New 1939 **RADOLEK PROFIT GUIDE**.

Radolek has everything under one roof. When you order, you get just what you want promptly and economically. Over 25,000 Radio Servicemen and Dealers now depend upon Radolek Service. Send for your copy of this big book.

OVER 12,000 REPAIR PARTS. Parts to repair any radio receiver made. All leading brands represented. Every item guaranteed! And all at prices that **SAVE YOU MONEY!**

ALL TUBES REPRESENTED. RCA, Sylvania, Raytheon, Philco, etc. Includes Kellogg, special Majestic types and transmitting tubes.

TEST INSTRUMENTS. The most complete line ever displayed in any catalog. Latest improved models that provide every conceivable test necessary for thorough radio receiver analysis.

COMPLETE PUBLIC ADDRESS DISPLAY. New 1939 model public address amplifiers with outputs from 10 to 100 watts. Complete P.A. Systems for permanent, Mobile and Portable Installations. Attractively designed and priced for greater profits.

LATEST RADIO MODELS. The super values of 1939. New Photo-Radio combinations. Automatic tuning sets. Strikingly beautiful cabinets. Also new "Ham" receivers and transmitters!

COMPLETE AUTO RADIO SECTION. Includes vibrator replacement guide, new auto aerials, custom panel control plates for all automobiles and new Delco Auto Sets.

3000 NEW ITEMS OVER PREVIOUS EDITION. New items to give you new ideas in conducting your business on a more profitable basis.

The RADOLEK Co.

601 W. Randolph, Chicago, Dept. C-26

Send the 1939 Radolek Radio Profit Guide FREE.

Name

Address

Serviceman? Dealer? Experimenter?

MICHIGAN AVENUE

WHERE
CHICAGO
Lives

● The pulse of the city — Michigan Avenue.

Chicago works and plays to the tune of its rhythmic hum. In the most convenient location on this famous thoroughfare, Hotel Auditorium provides spacious pleasant rooms, excellent service and superb cuisine, at reasonable rates.

WITH BATH FROM \$2.50 WITHOUT BATH FROM \$1.50

AUDITORIUM

MICHIGAN AT CONGRESS GEO. H. MINK, Manager

NEW

BOOK BY RIDER

COMPLETELY EXPLAINS



The Fastest Method of Trouble-Shooting

The book you have waited for! Hard covers, profusely illustrated. Priced so you will order it NOW!

\$2.00

"Greatest speed in trouble-shooting"—that's the need of all radio servicemen. In the Laboratories of Successful Servicing, John F. Rider, familiar with the problems of the serviceman, developed a method of locating troubles in receivers which is the fastest and surest method yet devised. It is based upon the most fundamental thing in any receiver, the signal. Learn how you can save hundreds of hours during the new year; learn about the sensational new method of "Servicing by Signal Tracing." Order your copy today!

JOHN F. RIDER, Publisher
404 FOURTH AVE., NEW YORK CITY

DID YOU SAY 9?

YOU NEED ALL 9 Rider MANUALS

YES I SAID 9!

BOOK REVIEW

MENLO PARK REMINISCENCES, Vol. I. by Francis Jehl. Published by Edison Institute. Size 4½ x 7½ ins., 440 pgs., price 50c in paper and \$1 in cloth. Approx. 350 illustrations.

This reviewer is loathe to tear himself away from Jehl's enchanting "Reminiscences" long enough to write this review; and is only cajoled into so doing by the pleasurable anticipation of doing a review on Vol. II, which will soon make its appearance.

Briefly, this new book presents a picture of world-famous Menlo Park as it was during the achievements of Thomas A. Edison. It was written in Edison's restored Menlo Park laboratory—now located at Henry Ford's Dearborn, Michigan, museum of priceless Americana—by a former laboratory assistant of the renowned savant of the tiny New Jersey town (and highest point between New York and Philadelphia).

The story of fortitude and perseverance anyone can read between the lines of this *multum-in-parvo* book is inspirational material of the first order. Every school should have a copy of this easy-to-read book; and every radio man worthy of the name should make certain that "Reminiscences" is included in his library. This little book fairly drips with meaty information concerning the early inventions of Edison prior to the year 1879.

Space does not permit us to give more than a brief analysis of the contents of this book; in fact, we must content ourselves with listing, below, only those chapters having titles which are highly descriptive of the subject matter.

Part One: Chapter V—The Telegraph Table in the Corner; IX—A Telegraph That Would Write; X—A New Scientific Discovery—The Motograph; XI—Four Messages Over a Single Wire; XII—Ethereic Force—The Famous Black Box; XIII—Edison and the Wireless (in 1885!); XIV—The Electric Pen—The Mimeograph; XV—Edison and the Telephone—Introduction; XX—The Battle of the Microphones; XXIV—Development of Phonograph. Part Two: Chapter XXXIII—Looking for a Metallic Lamp; XXXVI—The Loud-Speaking Telephone.

CORRECTIONS

"Making a Serviceman's Test Unit—The Super-Geno-Scope"

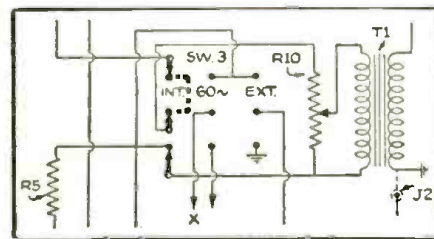

In Part I (December, 1938, *Radio-Craft*), Fig. 1, pg. 343, a slip-up occurred in connection with the wiring of switch Sw.3 ("INT.-60 CY.—EXT."); the correct wiring is shown above. (Error called to our attention by Mr. E. Klugman, Nashville, Tenn.)

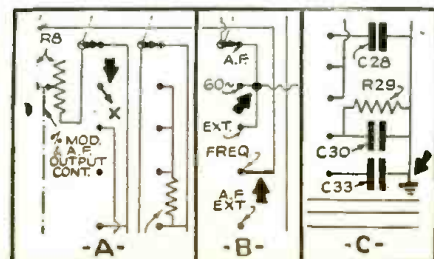

In Part II (January, 1939), Fig. 2, pg. 409, errors occurred, as corrected above, at A and B of switch Sw.4; and C, at condenser C33.

Index to advertisers

A	
Allied Radio Corporation.....	491
Amplifier Co. of America.....	498
Arrow Sales Company.....	500
Auditorium Hotel.....	511
B	
Brush Development Company.....	495
Burstein-Applebee Company.....	500
C	
Capitol Radio Engineering Inst.....	498
Central Radio Laboratories.....	490
Classified Section.....	508
Cornell-Dubilier Corp.....	509
Coyne Electrical School.....	451
D	
The Data Print Company.....	490
E	
Eastman & Majestic Hotels.....	510
H	
Hammarlund Mfg. Company.....	495
Howard Radio Corporation.....	501
Hudson Specialties Co.....	504
Hygrade Sylvania Corp.....	512
I	
International Correspondence Schools.....	495
International Resistance Company.....	503
K	
Kelsey Company.....	502
L	
Lancaster, Allwine & Rommel.....	502
Lincoln Engineering School.....	502
Dr. F. Loewenberg.....	507
M	
Meissner Mfg. Co.....	Inside Front Cover
Midwest Radio Corp.....	488
Miles Reproducer Co., Inc.....	500
Modell's.....	502
N	
National Plans Institute.....	510
National Radio Institute.....	449
National Schools.....	495
National Union Radio Corp.....	499
New York YMCA Schools.....	492
R	
Radio Circular Company.....	492
Radio & Tech. Publishing Co.....	488, 493, 500
Radio City Products Co.....	494
Radio Servicemen of America, Inc.....	506
Radio Training Association.....	491
Radolek Company.....	511
RCA Institutes, Inc.....	488
RCA Mfg. Company.....	Back Cover
Readrite Meter Works.....	493
Remington Rand, Inc.....	508
John F. Rider.....	512
S	
Service Instruments, Inc.....	489
Solar Manufacturing Co.....	493
Sprague Products Company.....	492
Sprayberry Academy of Radio.....	486
Superior Instruments Co.....	Inside Back Cover
Supreme Instruments Corp.....	493
T	
Technifax.....	508
Teletran Products Company.....	496
Test Equipment Co. of America.....	499
Triplet Electrical Instr. Co.....	505
U	
United Radio Company.....	488
W	
Montgomery Ward & Co.....	507
Wellworth Trading Company.....	502, 496
Wholesale Radio Service Co., Inc.....	497
Williams Philco, Inc.....	494
Wright-DeCoster, Inc.....	509

(While every precaution is taken to insure accuracy, we cannot guarantee against the possibility of an occasional change or omission in the preparation of this index.)

SUPERIOR PRESENTS 5 INSTRUMENTS

from its NEW 1100 series!!!! Never before has Superior offered so much for so little! Always the Best Buy in the Instrument Field, Superior in this new 1100 series gives you even more value! We have incorporated many refinements, many new features . . . all proven to be sound and practical. We urge you to read the descriptions below carefully; see how these instruments fit your needs. Buy direct from manufacturer and save 50%.

ments, many new features . . . all proven to be sound and practical. We urge you to read the descriptions below carefully; see how these instruments fit your needs. Buy direct from manufacturer and save 50%.

SUPERIOR INSTRUMENTS ARE GUARANTEED FOR ONE YEAR

THE NEW MODEL 1110-S

A.C. - D.C. VOLT OHM MILLIAMMETER

A Midget in Size - A Giant in Performance

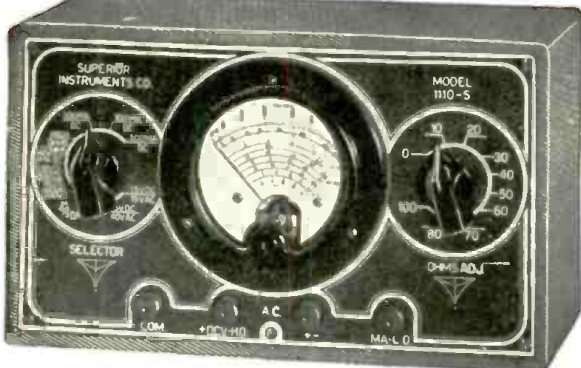

Features modern 0-1 d'Arsonval type meter, precision resistors, neat etched panel housed in new striped fabricoid case.

SPECIFICATIONS:

0-1.5 volts D.C.	0-500 ohms	500-500,000 ohms.	0-15 volts A.C.
0-15 volts D.C.	0-1 ma. D.C.		0-40 volts A.C.
0-25 volts D.C.	0-10 ma. D.C.		0-75 volts A.C.
0-75 volts D.C.	0-100 ma. D.C.		0-200 volts A.C.
0-500 volts D.C.	0-500 ma. D.C.		0-1200 volts A.C.

Model 1110-S supplied complete with batteries, test leads and instructions. Size: 8 1/4" x 5" x 3 1/4". Shipping weight, 5 1/4 pounds. Our net price.

\$7⁸⁵

THE NEW MODEL 1130-S

Signal Generator with Audio Frequencies



SPECIFICATIONS:

1. Combination R.F. and Audio Signal Generator, R.F. 100 kc. to 100 Mc., A.F.—100-7,500 cycles. All Direct reading, all by front panel switching.
2. R.F. and A.F. output independently obtainable alone or with A.F. (any frequency) modulating R.F.
3. Accuracy is within 1% on I.F. and Broadcast bands; 2% on higher frequencies.
4. Audio frequencies in 5 bands; 100, 400, 1000, 5000, and 7500 cycles.
5. Giant airplane full vision, direct-reading dial.
6. Condenser and other leakages tested to 100 megohms.
7. All services on 90-130 volts A.C. or D.C. (any frequency).

Model 1130-S comes complete with tubes, test leads, carrying handle, instructions. Size 12" x 9" x 6 1/4". Shipping weight 15 pounds. Our net price.

\$11⁸⁵

THE NEW MODEL 1150-S

SUPER-ALLMETER

Featuring the New Sloping Panel



A genuine achievement! For accurate and rapid measurements. Note the following features: A.C. and D.C. Volts, A.C. and D.C. currents, Resistance, Capacity, Inductance, Decibels, Watts.

SPECIFICATIONS:

- D.C. Voltage: 0-15, 0-150, 0-750 volts D.C.
- A.C. Voltage: 0-15, 0-150, 0-750 volts A.C.
- D.C. Current: 0-1, 0-15, 0-150, 0-750 ma. D.C.
- A.C. Current: 0-15, 0-150, 0-750 ma. A.C.
- 2 Resistance Ranges: 0-500 ohms, 500-5 megohms
- High and Low Capacity Scales: .0005 to 1 mfd. and .05 to 200 mfd.
- 3 Decibel Ranges: -10 to +19, -10 to +38, -10 to +53.
- Inductance: 1 to 700 Henrys
- Watts:

Based on 6 mv. at 0 D.B. In 500 ohms. .006000 to 600 Utilizes new 3/4" square 0-1 d'Arsonval type meter with precision resistors housed in our newly devised sloping case for rapid and accurate servicing.

Model 1150-S supplied complete with test leads, tabular charts and instructions. Size 10" x 7 1/4" x 4 1/4", shipping weight 9 pounds. Our net price Model 1150-A Portable carrying cover 75c additional.

\$11⁸⁵

THE NEW MODEL 1180-S

SET TESTER

A Complete Laboratory All In One Unit!

Featuring Our New Type Sloping Panel for Precise and Rapid Servicing



A complete testing laboratory all in one unit! Combines Superior models 1140-S and 1150-S. For specifications read the description of both these models herewith. Comes housed in sturdy, black case with sloping panel for rapid and simple measurements. Complete with test leads, tabular charts, instructions and tabular data for every known receiving type tube, including many transmitting types. Size 11 1/2" x 9 1/4" x 5"; shipping weight 18 pounds Our net price Model 1180-A for Portable Cover, add 95c.

\$17⁸⁵

THE NEW MODEL 1140-S

TUBE TESTER



A really modern tube tester conforming to all standards of good engineering practice. Utilizes a 3" d'Arsonval type meter with calibrated scale. Furnished in a sturdy black case with sloping panel for easy operation. Removable cover and carrying handle for either portable or counter use.

SPECIFICATIONS:

1. Tests all 4, 5, 6, 7, 7L, and octal base tubes, including diodes.
2. Tests by the well-established emission method for tube quality, directly read on the GOOD? BAD scale of the meter.
3. Affords separate neon test for leakage and shorts between elements.
4. All services performed by the use of only five controls at maximum, and many tests do not require working all the controls.
5. Supplied with instructions and reference table so that the filament voltage and emission measuring controls may be properly set for the enumerated long list of tubes, which includes all tubes commonly encountered in servicing.
6. Works on 90-120 volts A.C. 60 cycle.

Model 1140-S comes complete with instructions and tabular data for every known receiving type of tube as well as many transmitting types. Shipping weight 10 pounds, size 10" x 7 1/4" x 4 1/4". Our net price Model 1140-A with Portable Cover 75c additional

\$10⁸⁵

SUPERIOR INSTRUMENTS CO.

136 Liberty St., RC-239
NEW YORK, N. Y.

**345,000 People
Go to Work
...When Radio Throws
the Switch**



NBC engineer Arthur V. Giammatteo throws a switch at Radio City that means entertainment for millions . . . employment for thousands.



The RCA Victor Family has many long-time members. Above is Group Supervisor Bessie Purnell, who has been with Victor for 32 of its 40 years.



8,000 American radio operators on ships and ashore handle hundreds of thousands of radio messages that help business and guard lives and property. Leaders in these activities are R. C. A. Communications, Inc., and Radiomarine Corporation of America, members of the family of RCA.

TO MOST AMERICANS today radio is entertainment, news, and education . . . the greatest show on earth. But to 345,000 workers and their families . . . a total of some 1,380,000 men, women and children . . . radio is even more than a show, it is a living. Where only a few years ago radio jobs were non-existent, now 700 odd radio stations and 500 and more factories create tens of thousands of jobs.

Radio a Boon to Thousands in Wholesale and Retail Businesses

About 25,000 are connected with wholesale establishments handling

radio merchandise. Retail radio merchants account for 56,000 and salesmen, service men, and others engaged in radio sales and service number 150,000.

For retailers and wholesalers as well as for the 19,000 members of its own organization, the Radio Corporation of America works aggressively to bring ever increasing prosperity by constantly improving the services radio gives the public. America has come to recognize the advantages in going "RCA ALL THE WAY." As a result . . . there is an ever richer field of opportunity for merchants who go RCA All The Way, too.

Listen to the "Magic Key of RCA" every Sunday, 2 to 3 P. M., E. S. T., on the NBC Blue Network.



RADIO CORPORATION OF AMERICA

RADIO CITY, N. Y.

RCA MANUFACTURING CO., INC.

RCA INSTITUTES, INC.

R.C.A. COMMUNICATIONS, INC.

RADIOMARINE CORPORATION OF AMERICA

NATIONAL BROADCASTING COMPANY