

LOW DISTORTION OSCILLATOR

G232

TYPE 1A70557

• AWA LIMITED 1986

This publication is copyright. Apart from any fair dealing as permitted under the Copyright Act, no part may be reproduced by any process without written permission.

HANDBOOK 70557R

ISSUE 3 15 JAN 86

Publishing Services
AWA LIMITED
Incorporated in New South Wales
CNR TALAVERA AND LANE COVE ROADS
NORTH RYDE NSW 2113 AUSTRALIA

TABLE OF CONTENTS

	<u>Section</u>
PART 1 GENERAL INFORMATION	
INTRODUCTION	1.1
BRIEF DESCRIPTION	1.2
PERFORMANCE	1.3
Environmental	1.3.1
Frequency	1.3.2
Distortion	1.3.3
Level	1.3.4
Output	1.3.5
Sync Output	1.3.6
OPERATIONAL AND MECHANICAL CHARACTERISTICS	1.4
ACCESSORIES PROVIDED	1.5
OPTIONAL ACCESSORIES	1.6
ORDER INFORMATION	1.7
PART 2 INSTALLATION	
UNPACKING AND INSPECTION	2.1
MOUNTING	2.2
CONNECTIONS	2.3
Power Connections	2.3.1
Output Connections	2.3.2
Alternative Output Connectors	2.3.3
Sync Output	2.3.4
REPACKING FOR SHIPMENT	2.4

70557R - TABLE OF CONTENTS

	<u>Section</u>
PART 3 OPERATION	
OPERATING CONTROLS	3.1
Power Switch	3.1.1
Frequency Range Switch	3.1.2
Coarse Frequency Control	3.1.3
Fine Frequency Control	3.1.4
10 dB Step Attenuator	3.1.5
Variable Attenuator	3.1.6
Z Source Switch	3.1.7
OPERATING PROCEDURES	3.2
Setting Frequency	3.2.1
Adjusting Output Level	3.2.2
Selecting Output Impedance	3.2.3
PART 4 TECHNICAL DESCRIPTION	
PRINCIPLES OF OPERATION	4.1
CIRCUIT DESCRIPTION	4.2
Two-Amplifier Phase Shift Oscillator	4.2.1
Level Control Circuit	4.2.2
Frequency Counter	4.2.3
Digital Readout	4.2.4
Attenuators	4.2.5
Output Amplifier and Transformers	4.2.6
Power Supply	4.2.7
PART 5 MAINTENANCE	
MAINTENANCE REQUIREMENTS	5.1
SERVICE	5.2
FAULT FINDING GUIDE	5.3

70557R - TABLE OF CONTENTS

	<u>Section</u>
PART 6 CALIBRATION AND TEST PROCEDURES	
SCOPE	6.1
TEST EQUIPMENT REQUIRED	6.2
CALIBRATION PROCEDURES	6.3
Level Calibration	6.3.1
Longitudinal Output Calibration	6.3.2
TEST PROCEDURES	6.4
Frequency Accuracy Test	6.4.1
Level Accuracy Test	6.4.2
Frequency Response Test	6.4.3
Distortion Test	6.4.4
Hum and Noise Test	6.4.5
Return Loss Test	6.4.6
Longitudinal Output Test	6.4.7
Sync Output Test	6.4.8
PART 7 COMPONENT SCHEDULE	
INTRODUCTION	7.1
Substitute Components	7.1.1
Component Ordering Data	7.1.2
LOW DISTORTION OSCILLATOR G232, 1A70557	7.2
Components Mounted on Chassis	7.2.1
Components on Printed Circuit Board 1R70558	7.2.2
Components Mounted on Display Board 1R70559	7.2.3
OPTIONS	7.3
Option 001 - Alternative Output Connector Kit 2M70574	7.3.1
Option 002 - Alternative Output Connector Kit 1M70565	7.3.2
Option 003 - Adaptor 1A70563	7.3.3
Option 004 - Adaptor 1A70564	7.3.4
Option 005 - Rack Mounting Kit 1M70575 ...	7.3.5
Option 006 - Alternative Output Connector Kit 2M70560	7.3.6
Option 007 - Alternative Output Connector Kit 2M70598	7.3.7
DRAWINGS	
Circuit Diagram	70557-0-10

70557R - TABLE OF CONTENTS

LIST OF FIGURES

- 4.1 Oscillator Block Diagram
- 4.2 Level Control Circuit Waveforms
- 4.3 Frequency Counter Block Diagram
- 4.4 Counter Timing - Low Ranges
- 6.1 Longitudinal Output Reference
- 6.2 Longitudinal Output Calibration
- 6.3 Level Accuracy Test
- 6.4 Test Circuit for Distortion Test
- 6.5 Return Loss Test
- 6.6 Longitudinal Output Test Reference
- 6.7 Longitudinal Output Test

LIST OF TABLES

- 6.1 Frequency Accuracy Test Settings/Results

EXPLANATION OF SYMBOLS

Marginal symbols which appear throughout this handbook have the following meanings:



Refer to an in-text drawing in this handbook.



Refer to a drawing at the rear of this handbook.



WARNING The accompanying warning contains information related to the safety of personnel.



CAUTION The accompanying caution contains information related to the protection of equipment.



NOTE The accompanying note contains information of special importance.

PART 1GENERAL INFORMATION

CONTENTS

	<u>Section</u>	<u>Page</u>
INTRODUCTION	1.1	1-2
BRIEF DESCRIPTION	1.2	1-3
PERFORMANCE	1.3	1-4
Environmental	1.3.1	1-4
Frequency	1.3.2	1-4
Distortion	1.3.3	1-4
Level	1.3.4	1-5
Output	1.3.5	1-6
Sync Output	1.3.6	1-6
OPERATIONAL AND MECHANICAL CHARACTERISTICS	1.4	1-7
ACCESSORIES PROVIDED	1.5	1-7
OPTIONAL ACCESSORIES	1.6	1-8
ORDER INFORMATION	1.7	1-8

70557R - PART 1
GENERAL INFORMATION

INTRODUCTION

1.1

This section gives a summary introduction to the facilities and application usage of the G232.

The AWA Low Distortion Oscillator G232 is a precision laboratory instrument which can be used in performance testing of high quality audio amplifiers and systems, and similar applications.

It features a balanced floating output with extremely low distortion and noise.



WARNING: This apparatus has been designed according to Class 1 of IEC Publication 348 Safety Requirements for Electronic Measuring Apparatus, and has been supplied in a safe condition. This instruction manual contains information and warnings which shall be followed by the user to ensure safe operation and to retain the apparatus in safe condition.

This section contains a brief description of the operational characteristics and facilities of the G232.

The G232 provides a balanced, floating output from 10 Hz to 110 kHz in four decade ranges with low noise and distortion. Both COARSE and FINE controls are provided for ease of setting the frequency. The operating frequency is displayed on a front panel mounted 3-1/2 digit readout. A multiplying circuit provides near-instant readouts at low frequencies.

The oscillator, a two-amplifier phase shift virtually bounce-free circuit, is fitted with high stability electronic level stabilisation. Stepped and variable attenuators make use of this high order stability to provide a precision calibrated output, free from errors associated with meter detector amplifiers and meters. The stepped attenuator is distributed so that some balanced attenuation is provided after the transformer for optimum noise performance.

The output is calibrated into a 600 ohms load from a switchable 600 ohms or 40 ohms source impedance, and may be unbalanced when required by connecting one terminal to the earth of the equipment under test. A square wave signal is available on the rear panel for oscilloscope synchronising. The G232 is designed with robust mechanical construction and to provide maximum ease of servicing.

70557R - PART 1
GENERAL INFORMATION

PERFORMANCE

1.3

This section lists the performance characteristics
of the G232.

Environmental

1.3.1

Operating temperature range:
0 degrees Celsius to 50 degrees Celsius

Frequency

1.3.2

Frequency range:
10 Hz - 110 kHz in 4 decade ranges

Frequency accuracy:
10 - 1100 Hz

Distortion (600 ohms load or greater)

1.3.3

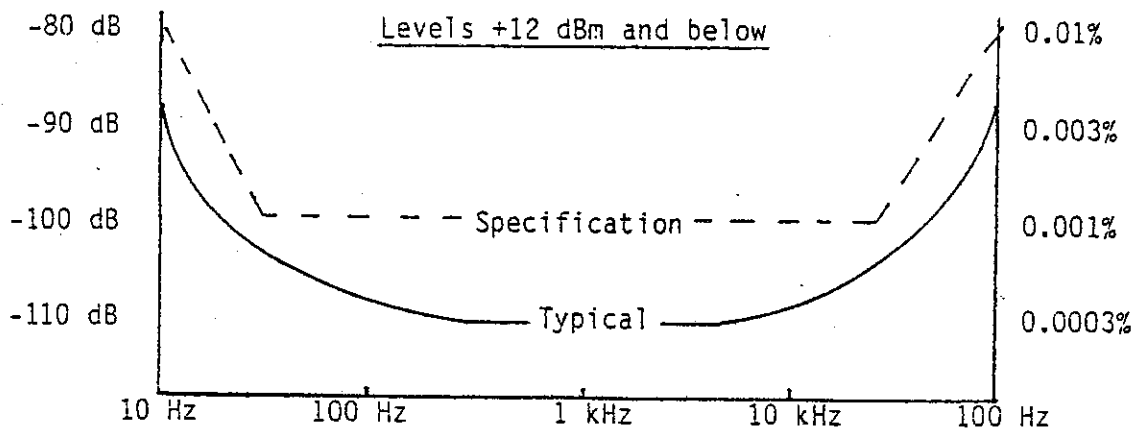

Distortion on +20 dBm Attenuator Setting

Output Level	10 Hz	20 Hz	30 Hz	1000 Hz	1 kHz	20 kHz	110 kHz
+22 dBm	-40 (-48)	-80 (-88)	-90 (-100)	-90 (-110)	-90 (-100)	-90 (-100)	-80 (-88)
+18 dBm	-70 (-77)	-90 (-96)	-90 (-106)	-90 (-110)	-90 (-103)	-90 (-100)	-80 (-86)
+12 dBm	-80 (-85)	-90 (-94)	-90 (-100)	-90 (-110)	-90 (-110)	-90 (-103)	-80 (-86)

Distortion in dB. Typical figures shown in brackets.

70557R - PART 1
GENERAL INFORMATION

Hum and Noise

	Bandwidth	
	20 kHz	110 kHz
Variable attenuator set to 0 dB	-95 dB	-95 dB
Variable attenuator set to -10 dB	-85 dB	-85 dB
Noise limit	-120 dB	-115 dB

Level

1.3.4

Level output:

Maximum +22 dBm (10 volts RMS)
into 600 ohms load

Absolute level accuracy 0 dBm at 25 degrees Celsius
and 1 kHz:

± 0.05 dB

Output attenuation:

+20 dBm to -70 dBm in 10 dB steps, plus a
variable attenuator of +2 dB to -30 dB
calibrated in
0.1 dB steps from +2 dB to -2 dB,
0.2 dB steps from -2 dB to -10 dB, thence
0.5 dB steps to -15 dB,
1 dB steps to -20 dB, then -25 dB and -30 dB

Output level is also calibrated in volts RMS

Attenuator accuracy:

Variable attenuator: $\pm 1\%$
10 dB step attenuator: ± 0.2 dB, any setting

Frequency response (wrt 1 kHz):

± 0.1 dB from 10 Hz to 30 kHz
 ± 0.2 dB from 30 kHz to 110 kHz

NOTE: The G232 output level is calibrated into
a 600 ohms termination for both 600 ohms
and 40 ohms output impedance.

70557R - PART 1
GENERAL INFORMATION

Output

1.3.5

Impedance:

40 ohms and 600 ohms balanced

Return loss of 600 ohms output

-40 dB : 20 Hz to 110 kHz, 10 to 40 degrees C

-35 dB : 10 Hz to 110 kHz, 0 to -50 degrees C

Longitudinal output:

-55 dB : 10 Hz to 30 kHz

-45 dB : 30 kHz to 110 kHz

Sync Output

1.3.6

1 volt peak-to-peak square wave from a 1 kilohm source impedance via a BNC connector on the rear panel.

70557R - PART 1
GENERAL INFORMATION

OPERATIONAL AND MECHANICAL CHARACTERISTICS

1.4

This section provides general operational characteristics and mechanical details of the G232.

Standard connectors:

Main output - Siemens Type 9 Re1 kli 6a or similar, 3-way, balanced;
Sync output - BNC;
Mains - IEC International mains socket.

Power supply for mains operation:

200 to 264 volts, 50-60 Hz, 15 VA; or,
100 to 132 volts, 50-60 Hz, 15 VA

Height:

146 mm including feet
133 mm with feet removed for rack mounting

Width:

430 mm

Depth:

397 mm (including handles and rear feet)
345 mm (behind mounting face, when rack mounted)

Weight:

9 kg

ACCESSORIES PROVIDED

1.5

This section lists the standard accessories provided with the G232.

Standard accessories supplied are:

<u>Quantity</u>	<u>Item</u>
1	Mains cable
1	Instruction manual
1	Mating output connector, (Siemens type Re1 stp 6ac, or similar)
1	Spare fuse.

70557R - PART 1
GENERAL INFORMATION

OPTIONAL ACCESSORIES

1.6

This section lists the accessories, separately available, which extend the application of the G232.

- Option 001 Alternative output connectors, twin jacks either for carrier or for tip, ring and sleeve plugs, and an alternative rear panel connector. A mating connector for the latter is supplied.
- Option 002 Alternative three 4 mm binding post output terminals, in place of standard 3-way balanced socket.
- Option 003 Adaptor, 3-pin male to three 4 mm binding posts.
- Option 004 Adaptor, 3-pin male to BNC female.
- Option 005 Rack Mounting Kit, enabling the unit to be mounted in a standard 483 mm rack, occupying three vertical units (133 mm total height).
- Option 006 Alternative output connector, two binding posts.
- Option 007 Alternative output connector, switched, Siemens.

ORDER INFORMATION

1.7

This section specifies the AWA identification and type numbers by which the instrument and optional accessories are identified.

The instrument is described as:

Low Distortion Oscillator G232, Type 1A70557.

Options are identified as follows:

- 001 Alternative Output Connector Kit 2M70574
002 Alternative Output Connector Kit 1A70565
003 Adaptor 1A70563
004 Adaptor 1A70564
005 Racking Mounting Kit 1M70575
006 Alternative Output Connector Kit 2M70560
007 Alternative Output Connector Kit 2M70598.

END

PART 2
INSTALLATION

CONTENTS

	<u>Section</u>	<u>Page</u>
UNPACKING AND INSPECTION	2.1	2-2
MOUNTING	2.2	2-3
CONNECTIONS	2.3	2-4
Power Connections	2.3.1	2-4
Output Connections	2.3.2	2-5
Alternative Output Connectors	2.3.3	2-5
Sync Output	2.3.4	2-6
REPACKING FOR SHIPMENT	2.4	2-7

70557R - PART 2
INSTALLATION

UNPACKING AND INSPECTION

2.1

This section details the general requirements to be observed in unpacking the instrument and inspecting it prior to use.



NOTE: It is advisable to retain the original container and packing case in the event that the instrument has to be repacked for transit at some future time.

The equipment should be inspected for any physical damage sustained during transportation. The accessories should be checked against the equipment schedule.



CAUTION: Whenever it is likely that the protection has been impaired, the apparatus shall be made inoperative and be secured against any unintended operation.

The protection is likely to be impaired, for example:

- if the apparatus shows visible damage;
- if the apparatus fails to perform the intended measurements;
- after prolonged storage under unfavourable conditions;
- after severe transport stresses.



CAUTION: Ensure that only fuses with the required rated current and of the specified type are used for replacement. The use of mended fuses and the short-circuiting of fuse-holders shall be avoided. The fuse should be of the current rating as marked on the rear panel for the mains voltage selected.

70557R - PART 2
INSTALLATION

MOUNTING

2.2

This section details the procedures for rack mounting the G232.

The G232 is fitted with bottom feet and a tilt bar for bench operation. The tilt bar enables the unit to be tilted upwards for easier operation.

If it is required to rack mount the G232 then Option 005 (Rack Mounting Kit) must be ordered. This adaptor kit is designed to mount the G232 in a standard 483 mm (19-inch) rack.

To prepare the G232 for rack mounting, remove the top and bottom covers, held on by two screws at each end of each cover. Remove the front feet, tilt bar and rear feet from the bottom cover. Refit the bottom and top covers.

Next, peel off the adhesive trim strip on the side of the two front handles and remove the outer two screws from the handles. Using the screws provided in the Rack Mounting Kit, screw the angle brackets onto the ends of the case, flange forward. The G232 is now ready for mounting into the rack.



CAUTION: The G232 does not require any cooling in ambient temperatures up to +50 degrees Celsius; however, an instrument of this type should not be mounted above high dissipation equipment without adequate ventilation.

70557R - PART 2
INSTALLATION

CONNECTIONS

2.3

This section details the necessary power and signal
connection arrangements for the G232.

Power Connections

2.3.1

The G232 will operate from 110 volts to 120 volts and 220 volts to 240 volts nominal AC mains supply, 50 Hz to 60 Hz. The voltage range is selected by a slide switch on the rear panel of the instrument. This voltage range should be checked before connecting the G232 to the supply.

Ensure that a fuse of the correct rating is fitted for the supply voltage range selected. These are shown on the rear of the instrument; for 110 volts to 120 volts range, a 200 mA anti-surge fuse should be used; for 220 volts to 240 volts range, a 100 mA anti-surge fuse should be used.

An international mains socket is fitted on the rear panel. The power cord supplied should be plugged into this and connected then to the mains power receptacle.

The mains plug shall only be inserted in a socket-outlet provided with a protective earth contact. The protective action shall not be negated by the use of an extension cord without protective conductor.



WARNING: Any interruption of the protective conductor inside or outside the apparatus or disconnection of the protective earth terminal is likely to make the apparatus dangerous. Intentional interruption is prohibited.

70557R - PART 2 INSTALLATION

Output Connections

2.3.2

The standard Siemens Halske Type 9 Rel kli 6a or equivalent output connector is a 3-contact in-line socket. The top contact is connected to chassis earth. The balanced output to the other two pins is from a source resistance of 600 ohms or 40 ohms, depending on the impedance selected on the Z SOURCE switch.



NOTE: The output is always calibrated for a 600 ohms load irrespective of the source impedance selected.

Alternative Output Connectors

2.3.3

Optional twin jacks for carrier or ring tip and sleeve are available. This kit (Option 003) also provides an alternative rear-panel connector.

If this option is ordered with the instrument it will normally be factory fitted.

If Option 003 is ordered separately, it is supplied with a set of fitting instructions, Modification Bulletin 70557/1, to enable the easy fitting of these alternative input connectors.

An option is also available (Option 007) which provides for a standard 3-contact in-line socket to be mounted on the rear panel of the equipment, for rear-panel input access for rack-mounted equipments. The front-panel input connector is replaced with a type which incorporates a switch which controls the connections from the rear-panel socket. Plugging a connector into the front-panel connector temporarily disconnects the rear-panel socket, allowing the G232 to be used as a normal test instrument.

If Option 007 is ordered with the instrument it will normally be factory fitted. If the option is ordered separately it is supplied with a set of fitting instructions, Modification Bulletin 70557/2.

70557R - PART 2
INSTALLATION

Options are available which replace the standard 3-contact in-line output socket on the front panel with binding posts:

- Option 003 provides for output via three binding posts;
- Option 006 provides for output via two binding posts.

Also available are optional plug-in adaptors, which plug in to the standard 3-contact output socket and mount alternative input connector arrangements:

- Option 004 provides a BNC female output connector.
- Option 003 provides three binding posts.

Sync Output

2.3.4

The SYNC output of a 1 volt peak-to-peak square wave from a 1 kilohm source is provided on a BNC connector on the rear panel.

PART 3OPERATION

CONTENTS

	<u>Section</u>	<u>Page</u>
OPERATING CONTROLS	3.1	3-2
Power Switch	3.1.1	3-2
Frequency Range Switch	3.1.2	3-2
Coarse Frequency Control	3.1.3	3-2
Fine Frequency Control	3.1.4	3-3
10 dB Step Attenuator	3.1.5	3-3
Variable Attenuator	3.1.6	3-3
Z Source Switch	3.1.7	3-3
OPERATING PROCEDURES	3.2	3-4
Setting Frequency	3.2.1	3-4
Adjusting Output Level	3.2.2	3-4
Selecting Output Impedance	3.2.3	3-4

OPERATOR SAFETY



WARNING: Any interruption of the protective conductor inside or outside the instrument or disconnection of the protective earth terminal is likely to make the instrument dangerous. Intentional interruption is prohibited.

OPERATING CONTROLS

3.1

This section explains the functions of the controls mounted on the front panel of the G232.

Power Switch

3.1.1



CAUTION: Before switching on the instrument, make sure that it is set to the voltage of the mains supply.

This switch applies mains power to the instrument. For safety, both line and neutral are switched.

An associated red LED indicator POWER ON indicates the presence of mains power.

Frequency Range Switch

3.1.2

The frequency range of the G232 is 10 Hz to 110 kHz, covered by four operating ranges:

10 Hz to 110 Hz
100 Hz to 1100 Hz
1 kHz to 11 kHz
10 kHz to 110 kHz.

When the correct frequency range is selected, the frequency may be tuned by the COARSE and FINE frequency control for the required frequency as displayed on the digital readout.

Coarse Frequency Control

3.1.3

This control enables the continuous setting of frequency over a range of 11 to 1. The range is set by the frequency range switch.

70557R - PART 3
OPERATION

Fine Frequency Control

3.1.4

This control allows fine control adjustments of frequency at the upper end of each frequency range.

10 dB Step Attenuator

This attenuator consists of a bank of 10 pushbutton switches which are used with the variable attenuator to determine the G232 output level.

Variable Attenuator

The output level of the G232 is controlled by two attenuators, a variable attenuator and a switched attenuator. The variable attenuator is calibrated in three scales; 0-3 volts, 0-10 volts, and -30 to +2 dBm.

The 0-3 or 0-10 volts scale to be used is determined by the 10 dB step attenuator switch setting.

Z Source Switch

This 2-position switch determines the output impedance of the G232. The two settings are 600 ohms and LOW (40 ohms). The output level is correct when the G232 is loaded with 600 ohms for both the 40 ohms and 600 ohms output impedances.

70557R - PART 3
OPERATION

OPERATING PROCEDURES

3.2

This section describes the operating procedures for the G232.

Setting Frequency

3.2.1

To set the frequency:

- a. Depress the pushbutton for the range containing the required frequency.
- b. Tune the COARSE frequency control to the required frequency. If necessary, use the FINE frequency control for better setting accuracy at the high end of the selected range.

Adjusting Output Level

To adjust the output level:

- a. Select the required output level range on the 10 dB step attenuator.
- b. Adjust the variable attenuator to the required output level. For best accuracy the variable attenuator should be used between -8 dBm and +2 dBm.

Selecting Output Impedance

Depress the pushbutton for the output impedance required.

END

PART 4TECHNICAL DESCRIPTION

CONTENTS

	<u>Section</u>	<u>Page</u>
PRINCIPLES OF OPERATION	4.1	4-3
CIRCUIT DESCRIPTION	4.2	4-5
Two-Amplifier Phase Shift Oscillator	4.2.1	4-5
Level Control Circuit	4.2.2	4-5
Frequency Counter	4.2.3	4-7
Digital Readout	4.2.4	4-7
Attenuators	4.2.5	4-8
Output Amplifier and Transformers	4.2.6	4-8
Power Supply	4.2.7	4-8
FIGURES		
4.1 Oscillator Block Diagram		4-4
4.2 Level Control Circuit Waveforms		4-4
4.3 Frequency Counter Block Diagram		4-6
4.4 Counter Timing - Low Ranges		4-6

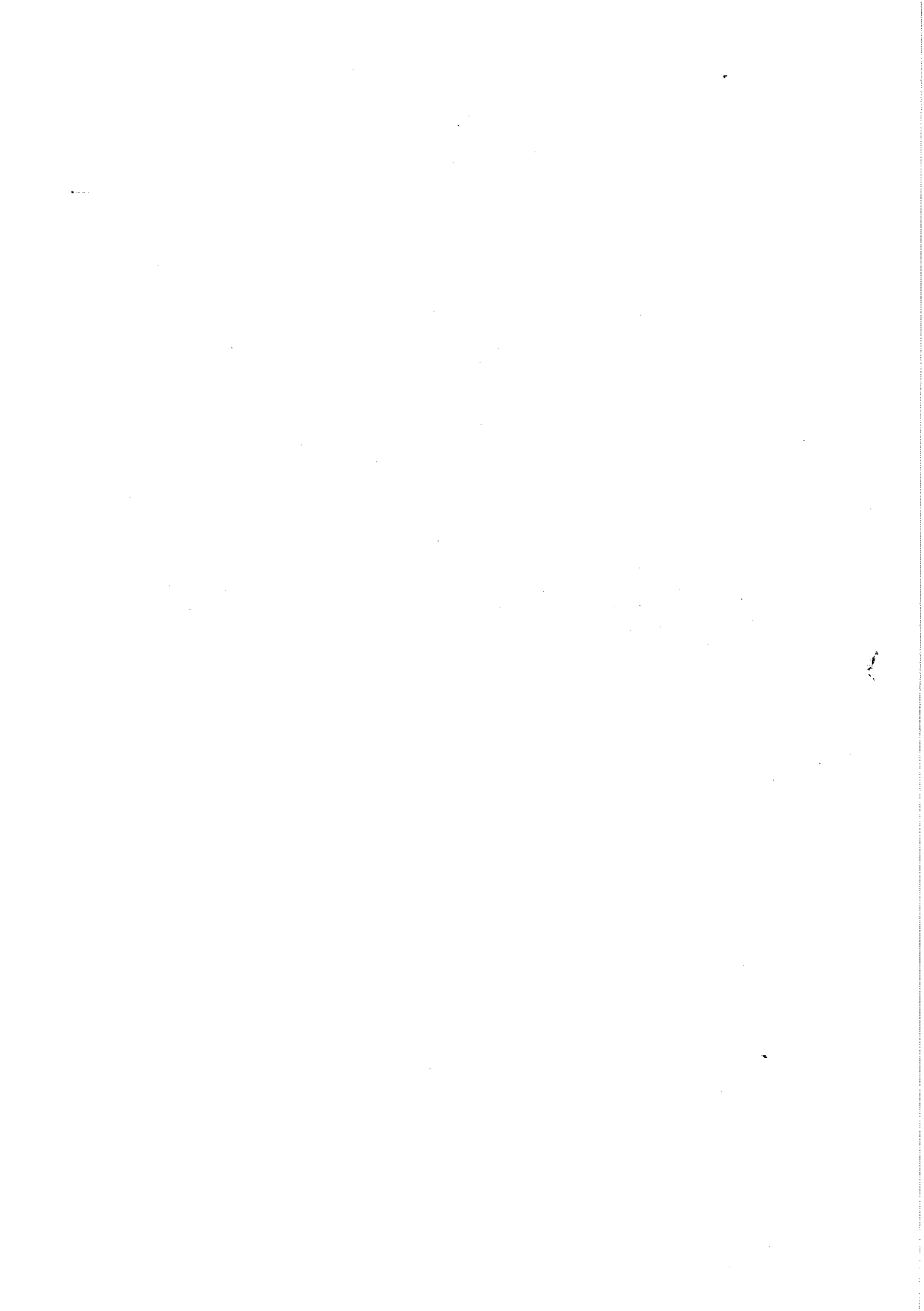

70557R - PART 4
TECHNICAL DESCRIPTION

PRINCIPLES OF OPERATION

4.1

This section gives a brief description of the principles of operation on which the design of the the G232 is based.

The G232 uses a two-amplifier phase shift oscillator with discrete transistor configuration.

The amplitude of the oscillator is sampled cycle by cycle and then compared to a reference voltage. The difference is integrated and a LED-controlled photo conductive cell (PCC) module is used to control the level.

The frequency of the oscillator is measured by a counter and displayed digitally. The frequency is multiplied on the lower two decade ranges to provide instantaneous readout of frequencies.

90 dB of attenuation is provided in a 10 dB step pushbutton attenuator which attenuates both before the output amplifier and after the output transformer to provide optimum noise performance.

A linear potentiometer between the preamplifier attenuator and the output amplifier is used as the variable attenuator.

Two output transformers are used, a low frequency transformer for the lower two decades, and a second transformer for the higher two decade frequency ranges.

The secondary windings are connected in series for 600 ohms output and in parallel for 40 ohms output. The transformers are followed by 600 ohms and 40 ohms balanced attenuators.

70557R - PART 4
TECHNICAL DESCRIPTION

FIGURE 4.1 Oscillator Block Diagram

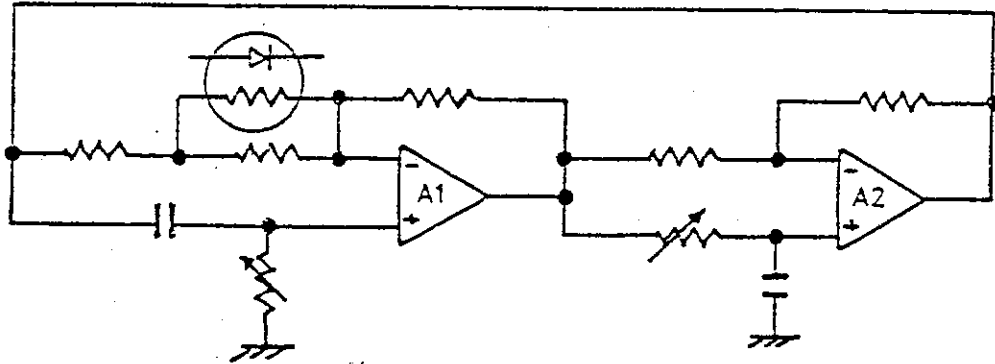
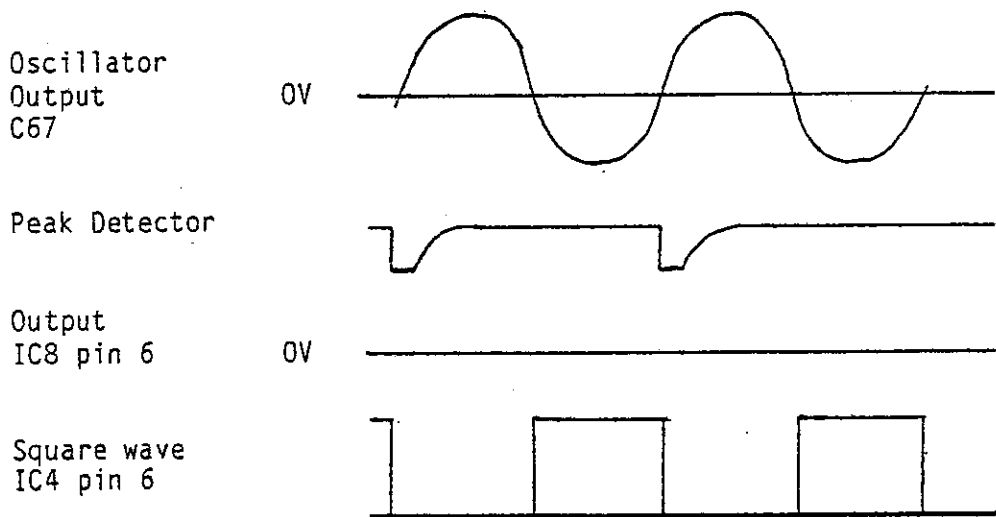

FIGURE 4.2 Level Control Circuit Waveforms



70557R - PART 4
TECHNICAL DESCRIPTION

CIRCUIT DESCRIPTION

4.2

This section provides a description of the circuit operation of the the G232.



REFER: Drawing 70557-0-10
Circuit Diagram

Two-Amplifier Phase Shift Oscillator

4.2.1



REFER: Figure 4.1
Oscillator Block Diagram

Amplifiers A1 and A2 are transistor amplifiers with double differential pairs to provide high linearity. Decade frequency switching is achieved by switching capacitors with SWA. Variable frequency change is achieved by the dual-ganged resistor RV2. Fine frequency adjustment is by RV1, which is connected in series with one gang of RV2.

Level Control Circuit

4.2.2



REFER: Figure 4.2
Level Control Circuit Waveforms

The level control measures the oscillator output cycle by cycle. The peak detector storage capacitor C73 is charged to the peak of the sine wave. IC4 is used as a comparator to obtain a square wave which triggers a monostable, IC6, to discharge C31 via IC7. The period of the monostable is shortened from 10 microseconds to 1 microsecond on the 10 kHz frequency range.

The output of the peak detector at IC8 is switched by the square wave to the input of the integrator IC9 and compared to the voltage at IC9:3. The output of the integrator is then fed via the transistor circuit Q44, Q46 and Q47 to PCC1 to control the output level. This circuit linearises the control loop gain at different PCC1 operating currents.

The monostable output at IC6:10 is used to retrigger a second monostable in IC6 that is used as precaution against any possible control loop latch up and blank the digital readout of frequency when there is no oscillator output.

70557R - PART 4
 TECHNICAL DESCRIPTION

FIGURE 4.3 Frequency Counter Block Diagram

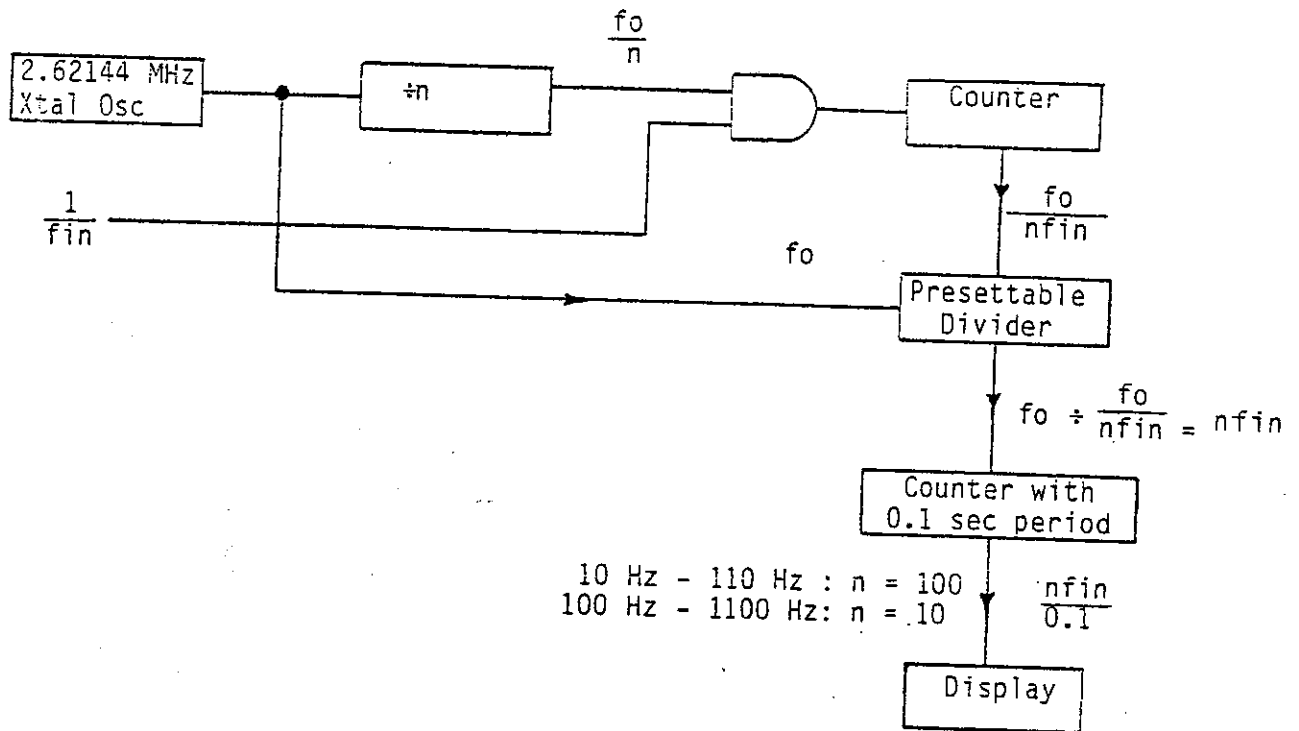
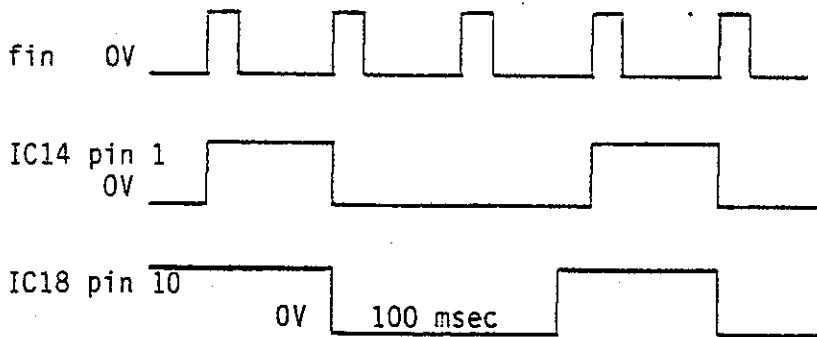

FIGURE 4.4 Counter Timing - Low Ranges



70557R - PART 4
TECHNICAL DESCRIPTION

Frequency Counter

4.2.3



REFER: Figure 4.3
Frequency Counter Block Diagram

Figure 4.4
Counter Timing - Low Ranges

Pulses are fed from IC6:10 to the counter circuit where there are two modes of operation, lower range and upper range.

On the lower two decade ranges the repetition rate of the pulses is multiplied before being fed into the counter as shown in Figure 4.3.

The crystal oscillator frequency is divided by 100 on the 10 Hz to 110 Hz range, and by 10 on the 100 Hz to 1100 Hz range, and gated with the period of the frequency to be measured (f_{in}).

The number of pulses, f_o/n_{fin} , allowed through the gate is stored in the counter IC19 and used to preset the dividers IC16, IC20 and IC24. The presettable dividers are clocked by f_o so that the output frequency at IC20:12 is $f_o/(f_o/n_{fin}) = n_{fin}$. The pulses at n_{fin} repetition rate are counted by IC11 over a 100 milliseconds period so that the correct frequency is displayed. The timing in this mode is shown in Figure 4.4.

On the upper two frequency ranges the frequency multiplying circuitry is not used and the input pulses are counted directly over 0.1 seconds on the 1 kHz to 11 kHz range, and divided by 10 on the 10 kHz to 110 kHz by IC22 before counting.

Digital Readout

4.2.4

The LED digital readouts are strobbled by IC11 via transistors. The decimal points are switched by the frequency range switch.

70557R - PART 4
TECHNICAL DESCRIPTION

Attenuators

4.2.5

The 10 dB step attenuator provides 90 dB of attenuation, 60 dB before the output amplifier and 30 dB after the output transformer. RLA controls a 30 dB attenuator followed by RLB, RLC and RLD which provide a further 30 dB of attenuation in 10 dB steps.

A 5 kilohms linear potentiometer, RV3, follows to give variable control of level setting.

RLE and RLF control the balanced 40 ohms and 600 ohms attenuators that follow the output transformer.

Output Amplifier and Transformers

4.2.6

The signal from the variable level control RV3 is fed to the output amplifier. This amplifier has a double differential pair to provide high linearity and a push-pull Darlington output stage for high drive capability.

The output amplifier goes to RLG1, which feeds either the low frequency transformer T2 on the lower two decade frequency ranges, or the high frequency transformer T3 on the two higher decade frequency ranges.

The secondary windings of the output transformer in use are connected in series for 600 ohms output impedance and in parallel for 40 ohms output impedance.

Power Supply

4.2.7

The power supply consists of +24 volts, -24 volts and +12 volts series regulators IC1, IC2 and IC3. All supplies are internally protected against short circuits and thermal overloads.

The G232 may be used from either 120 volts or 240 volts mains, changeover being made with SWE.

END

PART 5
MAINTENANCE

CONTENTS

	<u>Section</u>	<u>Page</u>
MAINTENANCE REQUIREMENTS	5.1	5-2
SERVICE	5.2	5-3
FAULT FINDING GUIDE	5.3	5-5

This section gives general requirements and precautions that apply to maintenance procedures that may be performed on the G232.

This is a high performance instrument and, to maintain this performance level, periodic checks are advisable. Inspection should include checks on resistors to ensure that no signs of over heating are evident.

The wire used has an insulating coating of polyvinyl chloride, and the styrofoam capacitors also contain thermo-plastics which must not be subjected to excessive heat.



CAUTION: Should servicing be required, guard against a hot soldering iron coming into contact with or being placed near the wiring forms or capacitors.



WARNING: The opening of covers or removal of parts, except those to which access can be gained by hand, is likely to expose live parts, and also accessible terminals may be live.

The apparatus shall be disconnected from all voltage sources before any adjustment, replacement or maintenance and repair during which the apparatus shall be opened.

If any adjustment, maintenance or repair of the opened apparatus under voltage is inevitable, it shall be carried out only by a skilled person who is aware of the hazard involved.

This section details the recommended servicing procedures to apply to the G232.



NOTE: It is important to note when servicing this instrument that any replacement of circuit components may require a re-adjustment of the pre-set controls to restore the instrument to its original calibrated condition.

Service work of any kind, particularly on sub-miniature components, should be carried out with care. For example, when replacing transistors and diodes, permanent damage can be caused by the application of excessive heat.

Should it be found during inspections that dust has accumulated inside the instrument it can be removed by a low pressure jet of air, or alternatively by a soft brush used lightly.

Switch control cleaning and lubricating should always be done with an appropriate compound, and the use of abrasives should be avoided.

A number of agents for cleaning switch contacts are available, usually in aerosol packs; one such suitable cleaner is Freon TF, although any equivalent agent could be used.

Lubrication of switch contacts requires a low-residue agent which does not attract dust; one such suitable lubricant is Vydax AR, although any equivalent agent could be used.

70557R - PART 5
MAINTENANCE

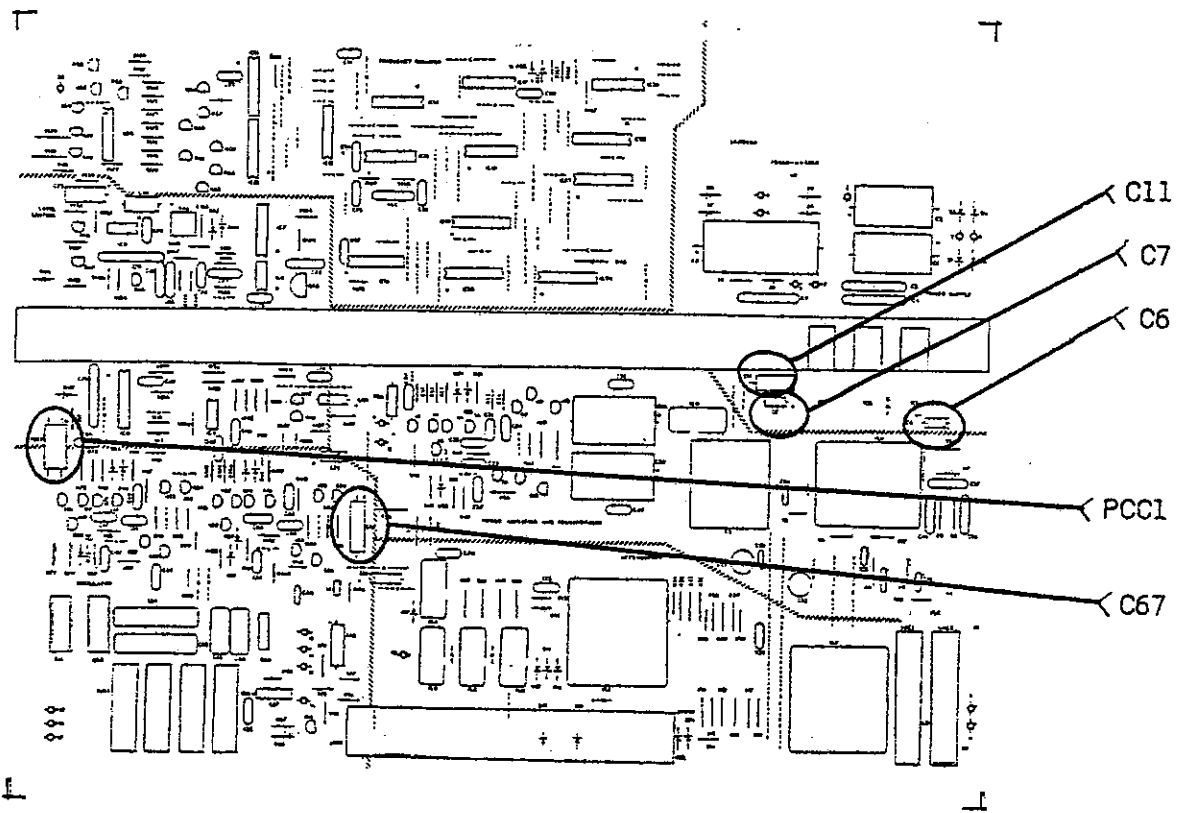

This section gives a sequence of procedures and checks that should be performed in the event that the G232 appears to malfunction.

Step Action

1. Check that the front panel controls are set correctly; that is, that the correct frequency range button is depressed, that the output attenuator is set correctly, and that the correct output impedance button is depressed.
2. Check that power is connected to the G232; the POWER ON indicator should be illuminated.
3. Remove the top cover and check that the supply voltages are present; +24 volts (+ end of C6), -24 volts (- end of C7), and +12 volts (+ end of C11).
4. Check with an oscilloscope to see if there is an oscillator output present at C67. If no output is observed, short the two leads on the oscillator side of PCC1 together with a clip lead:
 - a. If there is now an output from the oscillator, then the fault is most likely to be in the level control circuit; proceed to Step 6.
 - b. If there is still no oscillation the fault is most likely in the oscillator section; proceed to Step 5.
5. If the fault appears to be in the oscillator section, remove the clip lead shorting PCC1 and check:
 - a. the DC voltages around the amplifiers, and
 - b. the frequency-determining resistors and capacitors and associated switches.

70557R - PART 5
MAINTENANCE

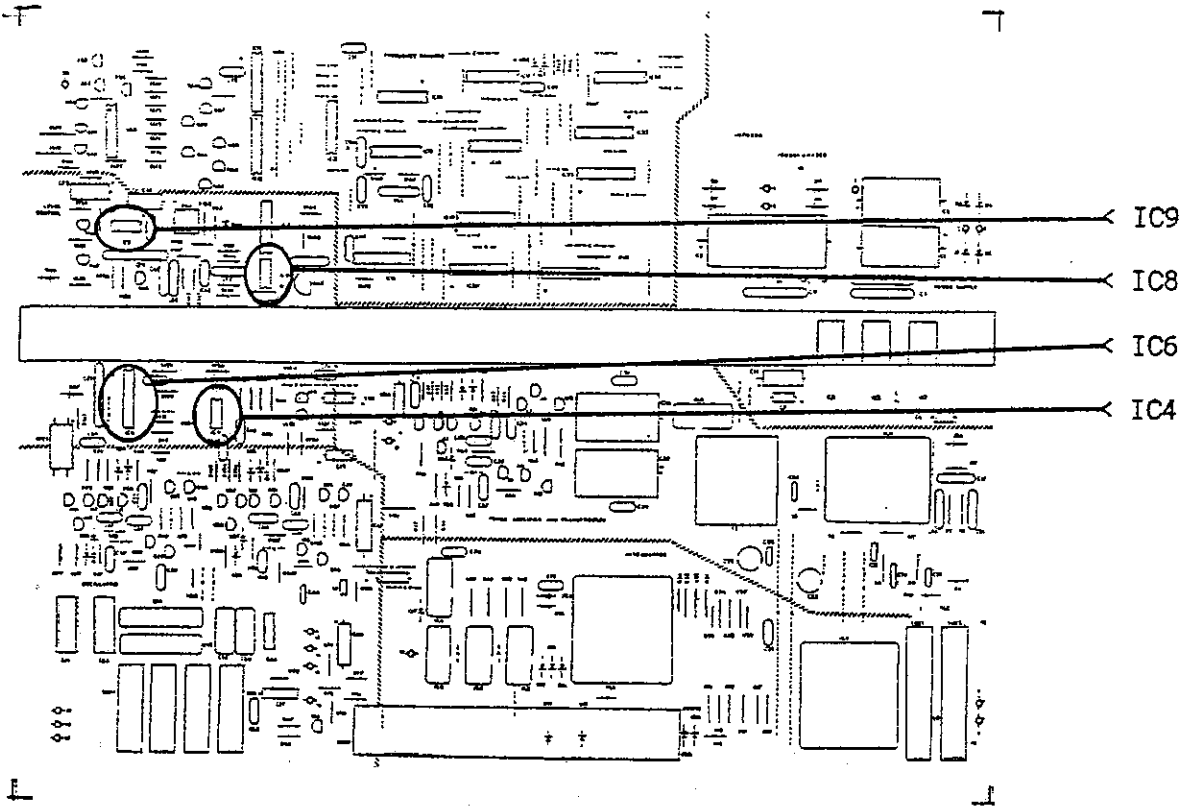

70557R - PART 5
MAINTENANCE

Step Action

6. If the fault appears to be in the level control circuit, leave the clip lead shorting PCC1 and:
 - a. check for a square wave signal at IC4:6,
 - b. check for 1-microsecond or 10-microsecond pulses at IC6:10,
 - c. remove the clip lead from PCC1 and check the output at IC8:6, which should be 0 volts when there is no oscillation, and
 - d. check the output of IC9:6, which should be -12 volts when there is no oscillation.
7. Set attenuators for maximum output level and check for signal at the output amplifier input and output. If there appears to be a fault, check signal paths and amplifier DC voltages.
8. If there is still a fault, follow the signal path through the appropriate transformer and output attenuator to the output socket.
9. If the signal is present and the digital display appears incorrect, connect a frequency counter to either the SYNC output or the OUTPUT socket. Set the frequency to 2 kHz on the external frequency counter; the internal display should read the same frequency. If the frequencies are not the same, proceed to Step 10; if the frequencies are the same, proceed to Step 11.

70557R - PART 5
MAINTENANCE

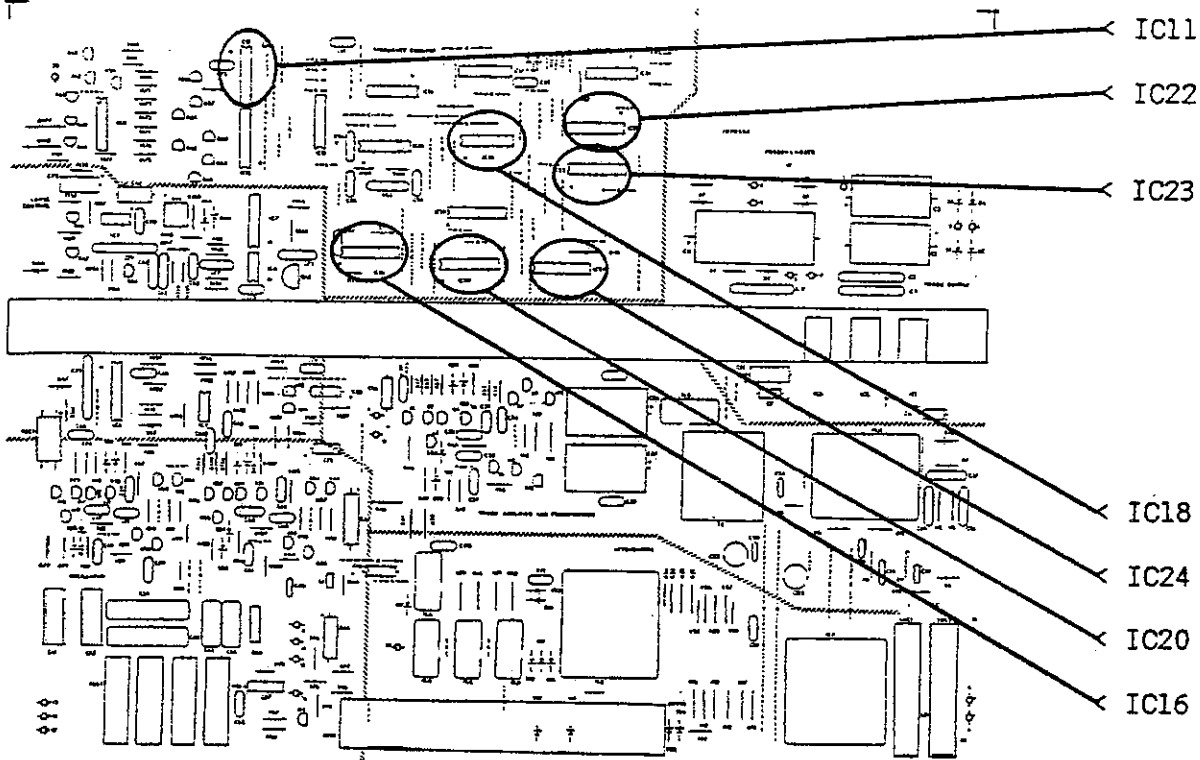

70557R - PART 5
MAINTENANCE

Step Action

10. If the frequencies are not the same:
 - a. check for 100-millisecond inverted pulses at IC23:11, and
 - b. check for pulses at oscillator frequency at IC11:12.

11. If the same frequencies are displayed on both the display and the external counter, set the G232 frequency to 200 Hz on the external frequency counter. The G232 is now in the frequency multiply mode; check:
 - a. for 26 kHz on IC22:14,
 - b. for gated pulses on IC18:11, and
 - c. that IC16, IC20, and IC24 are dividing.

END

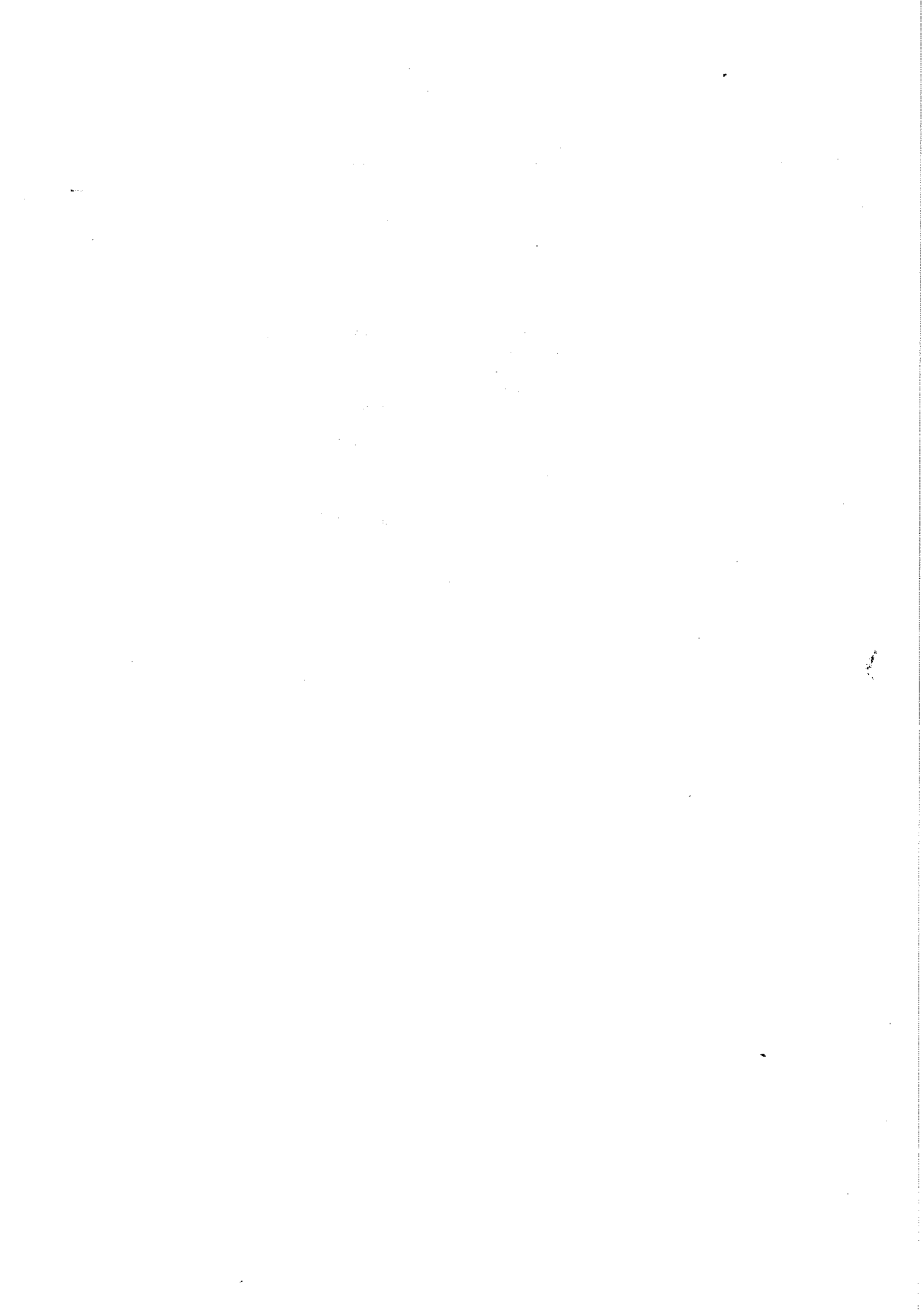

PART 6CALIBRATION AND TEST PROCEDURES

CONTENTS

	<u>Section</u>	<u>Page</u>
SCOPE	6.1	6-2
TEST EQUIPMENT REQUIRED	6.2	6-3
CALIBRATION PROCEDURES	6.3	6-5
Level Calibration	6.3.1	6-5
Longitudinal Output Calibration	6.3.2	6-7
TEST PROCEDURES	6.4	6-9
Frequency Accuracy Test	6.4.1	6-9
Level Accuracy Test	6.4.2	6-10
Frequency Response Test	6.4.3	6-11
Distortion Test	6.4.4	6-13
Hum and Noise Test	6.4.5	6-15
Return Loss Test	6.4.6	6-15
Longitudinal Output Test	6.4.7	6-17
Sync Output Test	6.4.8	6-17
FIGURES		
6.1	Longitudinal Output Reference	6-6
6.2	Longitudinal Output Calibration	6-6
6.3	Level Accuracy Test	6-10
6.4	Test Circuit for Distortion Test	6-12
6.5	Return Loss Test	6-14
6.6	Longitudinal Output Test Reference	6-16
6.7	Longitudinal Output Test	6-16
TABLE		
6.1	Frequency Accuracy Test Settings/Results	6-8

70557R - PART 6
CALIBRATION AND TEST PROCEDURES

SCOPE

6.1

This section defines the type and purpose of the procedures included in this part.

Two types of procedures are detailed in this part. They are:

- a. Calibration procedures, by which longitudinal output and output level can be routinely checked.
- b. Test procedures, by which the performance of the instrument may be validated either as a routine maintenance procedure or as an aid to fault location.

Due to the nature and probable use of this instrument, no recommendations are made as to the frequency at which these procedures should be performed. Users should determine the requirement in accordance with the type and amount of use to which the instrument is subject.

As a guide, it is advisable that calibration be performed whenever the instrument is required to be used after having been powered off, and that a full series of test procedures be performed periodically, the period being determined by the application and amount of use to which the instrument is subject.

70557R - PART 6
CALIBRATION AND TEST PROCEDURES

TEST EQUIPMENT REQUIRED

6.2

This section lists the test equipments and aids required to perform the full series of specified calibration and test procedures.



NOTE: Particular types/models of equipment items specified are intended to be representative only; any equivalent item may be used providing that in all relevant performance characteristics the item used is equivalent to the type/model specified. Some of the significant characteristics of items are shown, for guidance.

Items required are as follows:

- a. Level standard, W&G model EPM1; complete with probe TKS10, probe adaptor TKSA-600, and calibration adaptor TKSE-600.
- b. Distortion and noise meter, AWA model F240.
- c. Low distortion oscillator, AWA model G232.
- d. Level meter, Siemens model Rel 3D332.
- e. Frequency counter, to measure to an accuracy of 10 +/-0.1 Hz up to 110 kHz.
- f. Oscilloscope, with 15 MHz bandwidth.
- g. Attenuator, 75 ohms, precision, range 0-90 dB.
- h. Cable, with five turns wound on toroid core TDK type 1X27-HC2.
- i. Resistors, fixed:
 - 75 ohms +/-0.5%;
 - 150 ohms +/-2.0%;
 - 236 ohms +/-0.5%;
 - 300 ohms +/-0.5% (qty 2);
 - 600 ohms +/-0.5%.

70557R - PART 6
CALIBRATION AND TEST PROCEDURES

J. Test circuit for use in distortion test procedure (in Section 6.4.4), comprising:

Resistors, fixed:

- 2.2 kilohms;
- 3.39 kilohms;
- 5 kilohms;
- 6.8 kilohms,
- 10 kilohms.

Resistor, variable, 1 kilohm (qty 2);

Capacitors, fixed:

- 47 nF +/-2% (qty 2);
- 94 nF +/-2%;
- 470 pF +/-2% (qty 2);
- 940 pF +/-2%.

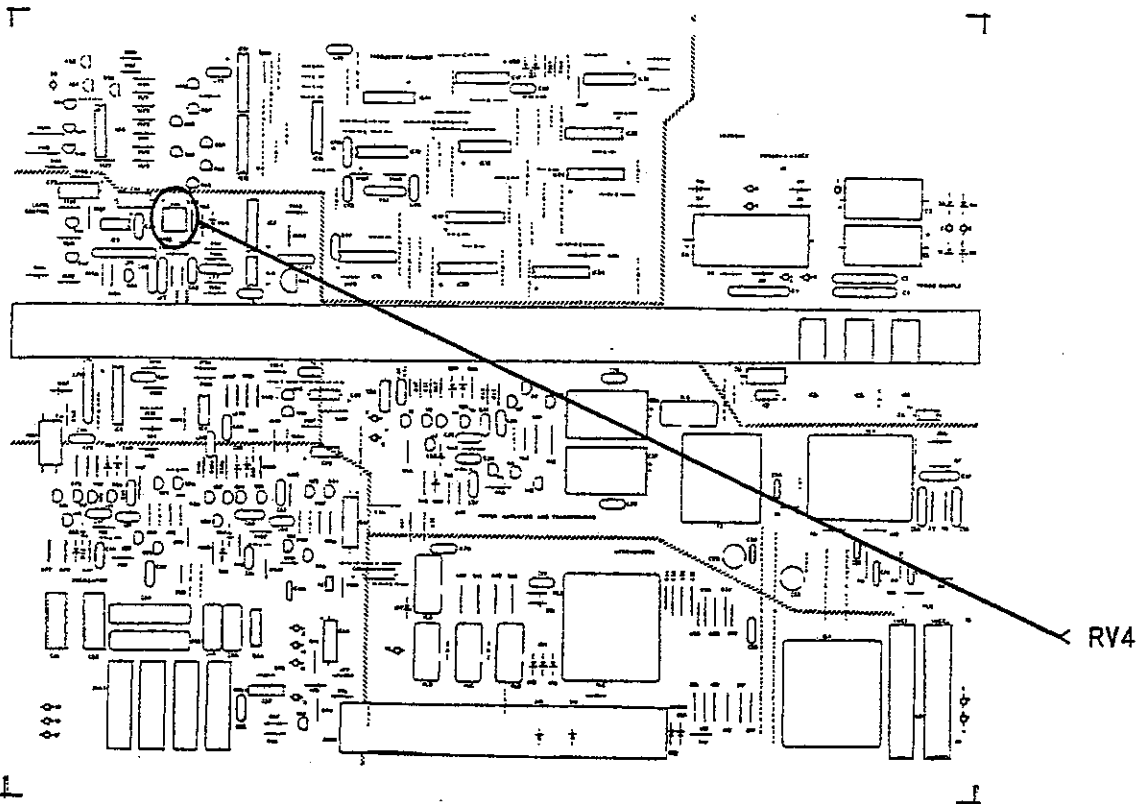

70557R - PART 6
CALIBRATION AND TEST PROCEDURES

CALIBRATION PROCEDURES

6.3

This section details the two calibration procedures, for level and longitudinal output.

Level Calibration

6.3.1

Step	Action
1.	Set the G232 to 1 kHz, 600 ohms output impedance.
2.	Set the 10 dB step attenuator to 0 dBm range.
3.	Connect the output of the G232 to the F240 unbalanced terminated input.
4.	Set the variable level control of the G232 fully to the 0V end of its range.
5.	Check the output level as indicated on the F240; it should be -50 dBm or lower.
6.	If the 0V end of the scale is not correct, loosen the nut on the knob and rotate the knob relative to the shaft until the output level is correct; retighten the knob nut.
7.	Connect the output of the G232 to the EP11, using the 600 ohms balanced adaptor.
8.	Set the variable level control of the G232 to 0 dBm.
9.	Check the output level as indicated on the EP11; it should be 0 dBm.
10.	If the output level is incorrect, adjust RV4 for 0 dBm output.

70557R - PART 6
CALIBRATION AND TEST PROCEDURES

FIGURE 6.1 Longitudinal Output Reference

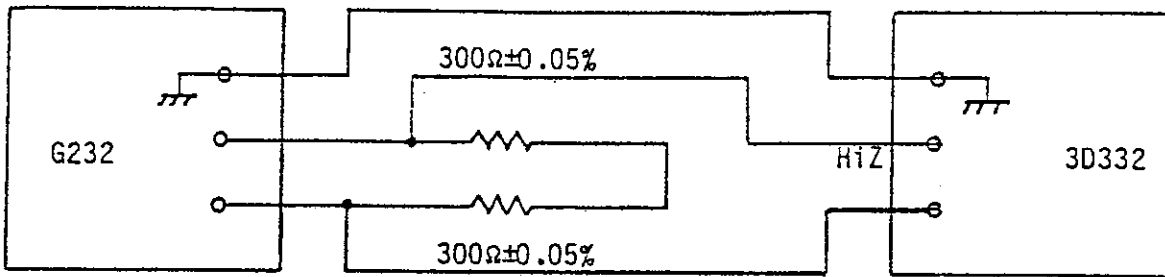
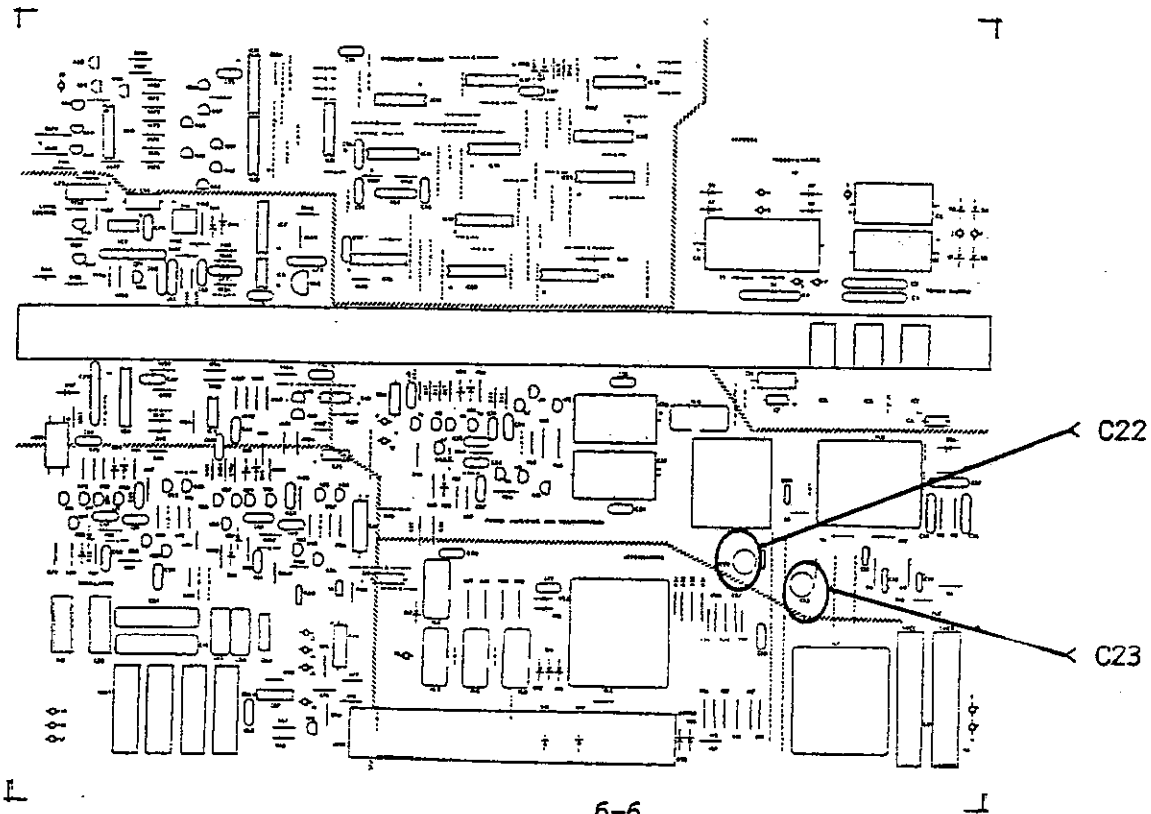
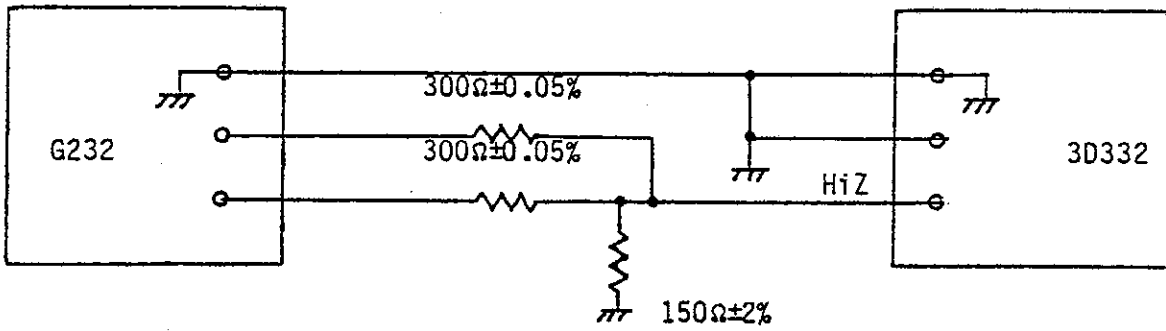

FIGURE 6.2 Longitudinal Output Calibration



70557R - PART 6
CALIBRATION AND TEST PROCEDURES

Longitudinal Output Calibration

6.3.2

Step	Action
1.	Set the G232 to 100 kHz, 600 ohms output impedance.
2.	Set the 10 dB step attenuator to -20 dBm range.
3.	Connect the output of the G232 to the Siemens 3D332 level meter as shown in Figure 6.1.
4.	Set the reference point on the level meter.
5.	Connect the output of the G232 to the Siemens 3D332 level meter as shown in Figure 6.2.
6.	Adjust C22 for minimum output as indicated on the 3D332.
7.	Set the G232 to 40 ohms output impedance, and adjust C23 for minimum output as indicated on the 3D332.
8.	Repeat steps 6 and 7 as necessary until the longitudinal output is at a level lower than 45 dB below the reference.

70557R - PART 6
CALIBRATION AND TEST PROCEDURES

TABLE 6.1 Frequency Accuracy Test Settings/Results

NOTE: 'X' indicates a 'don't care' setting.

Display	Range	Counter Reading
100	100-1100 Hz	Same as display +/-1 Hz
101	100-1100 Hz	Same as display +/-1 Hz
102	100-1100 Hz	Same as display +/-1 Hz
103	100-1100 Hz	Same as display +/-1 Hz
104	100-1100 Hz	Same as display +/-1 Hz
105	100-1100 Hz	Same as display +/-1 Hz
106	100-1100 Hz	Same as display +/-1 Hz
107	100-1100 Hz	Same as display +/-1 Hz
108	100-1100 Hz	Same as display +/-1 Hz
109	100-1100 Hz	Same as display +/-1 Hz
11X	100-1100 Hz	Same as display +/-1 Hz
12X	100-1100 Hz	Same as display +/-1 Hz
13X	100-1100 Hz	Same as display +/-1 Hz
14X	100-1100 Hz	Same as display +/-1 Hz
15X	100-1100 Hz	Same as display +/-1 Hz
16X	100-1100 Hz	Same as display +/-1 Hz
17X	100-1100 Hz	Same as display +/-1 Hz
18X	100-1100 Hz	Same as display +/-1 Hz
19X	100-1100 Hz	Same as display +/-1 Hz
2XX	100-1100 Hz	Same as display +/-2 Hz
3XX	100-1100 Hz	Same as display +/-2 Hz
4XX	100-1100 Hz	Same as display +/-3 Hz
5XX	100-1100 Hz	Same as display +/-3 Hz
6XX	100-1100 Hz	Same as display +/-4 Hz
7XX	100-1100 Hz	Same as display +/-5 Hz
8XX	100-1100 Hz	Same as display +/-5 Hz
9XX	100-1100 Hz	Same as display +/-6 Hz
10XX	100-1100 Hz	Same as display +/-6 Hz
11XX	100-1100 Hz	Same as display +/-7 Hz
10.0	10-110 Hz	10 +/-0.1 Hz
110.X	10-110 Hz	Same as display +/-0.7 Hz
1.00	1-11 kHz	1000 Hz +/-10 Hz
11.00	1-11 kHz	11000 Hz +/-10 Hz
10.0	10-110 kHz	10000 Hz +/-100 Hz
110.0	10-110 kHz	110000 Hz +/-100 Hz