

A
B

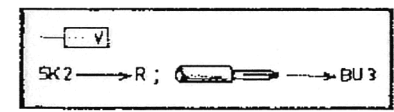

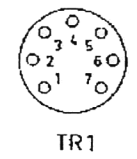

800 mV (SK1 → 10kΩ, SK2 → C)
 ~ 1000 Hz

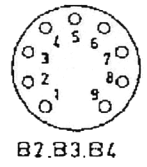
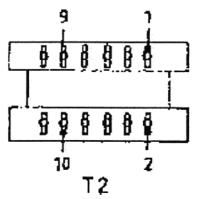
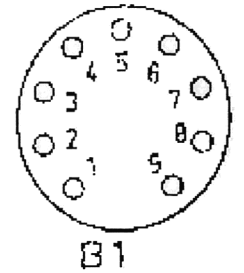
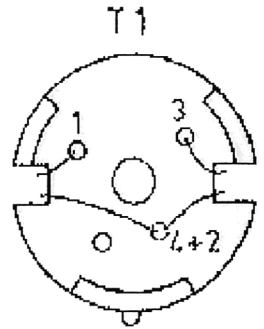
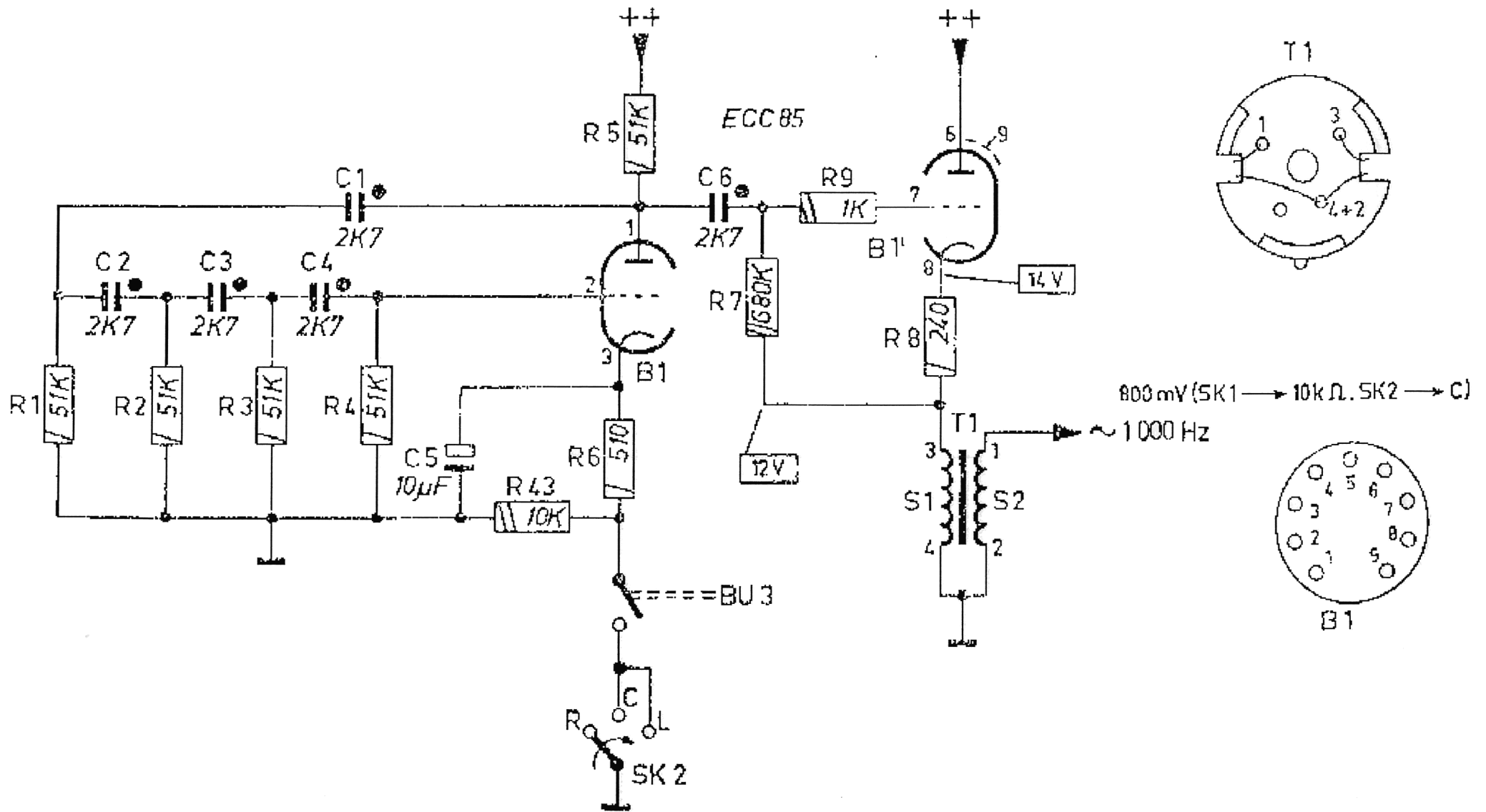