

I.F. = 465 K.C.

1935-36

MODEL 58

ALIGNMENT INSTRUCTIONS ON DATA SHEET-21

Terminals of Sockets

	1	2	3	4	5	6
6D6 ^{R.F.} AMP.		+ 53	+105	+ 5.8	+ 5.8	
6A7 ^{OSC.} MOD.		+225	+ 58	+145	- 4.4	+ 2.8
6D6 ^{I.F.} AMP.		+235	+105	+ 3.1	+ 3.1	
75 ^{DEM. A.V.C.} AUDIO		+ 61	0	0	+ 1.2	
42 ^{OUTPUT}		+225	+235	0	+13.5	
80 ^{RECT.}	+355	335	335	+355	-	-

SET TUNED TO 1000 K.C. "A" BAND.

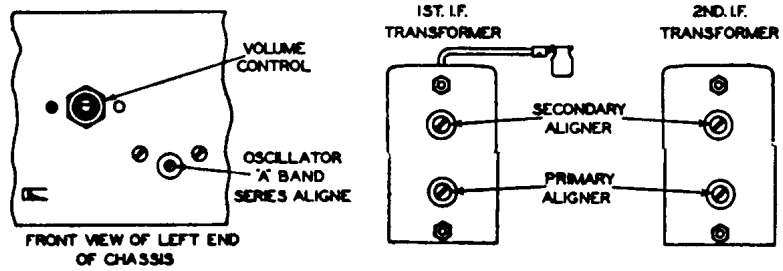
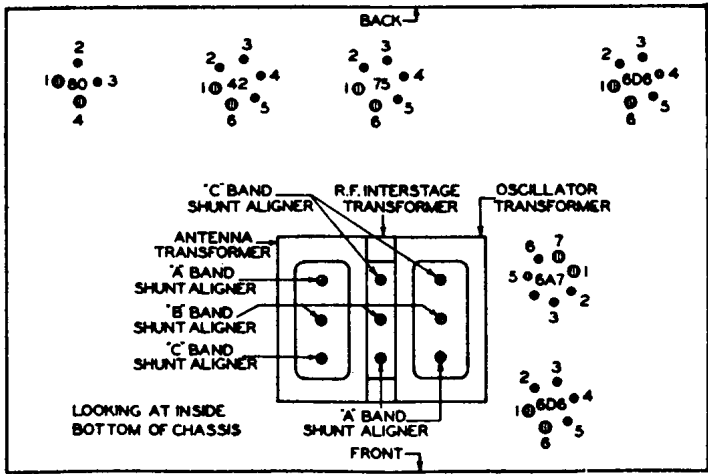

Terminal Layout for Voltage Measurement Chart and Location of Various Aligning Capacitors.

COURTESY - **STROMBERG-CARLSON-14**
 MFG. CO. LTD.
 PRINTED IN CANADA
DATA SHEET

I.F.=465 K.C.

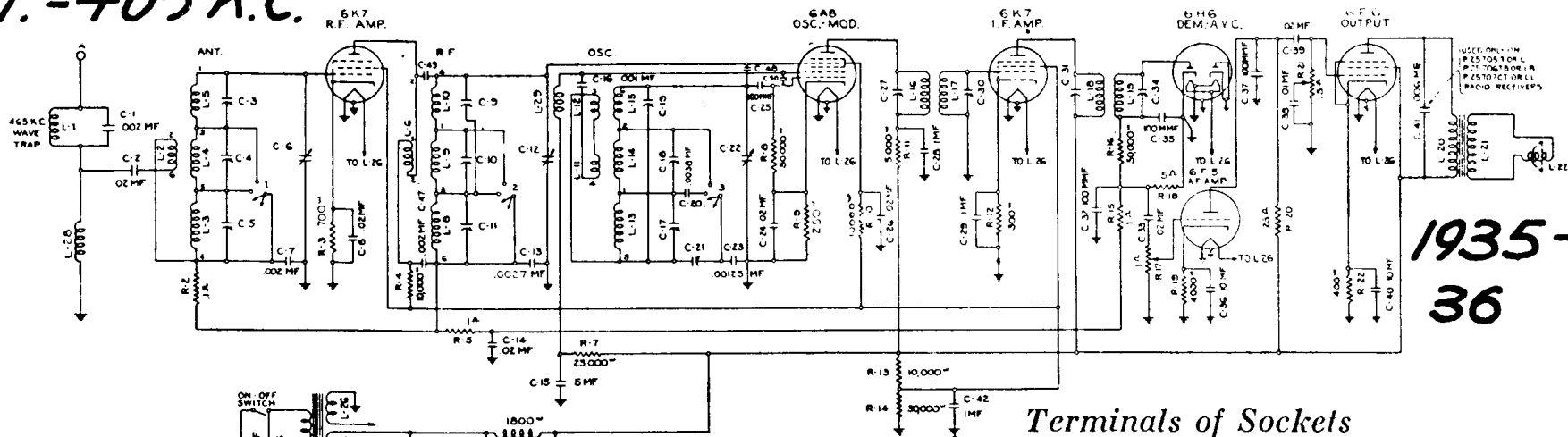

1935-36

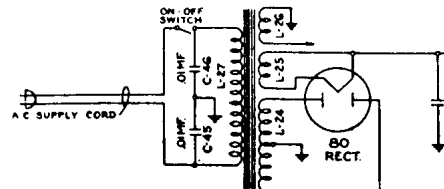

Terminals of Sockets

Tube	1	2	3	4	5	6	7	8
6K7 R.F. AMP.	0	0	+ 50	+100	+ 4.5	—	0	+ 4.5
6A8 OSC. MOD.	0	0	+220	+ 72	- 6	+160	0	+ 1.8
6K7 I.F. AMP.	0	0	+235	+100	+ 3	—	0	+ 3
6H6 DEM. A.V.C.	0	0	0	0	- .5	—	0	0
6F5 A.F. AMP.	0	0	—	+ 58	—	—	0	+ 1.2
6F6 OUT PUT	0	0	+220	+235	0	—	0	+14
80 RECT.	+355	335	335	+355	—	—	—	—

MODEL 61

ALIGN. INSTRUCTIONS ON DATA SHEET 21

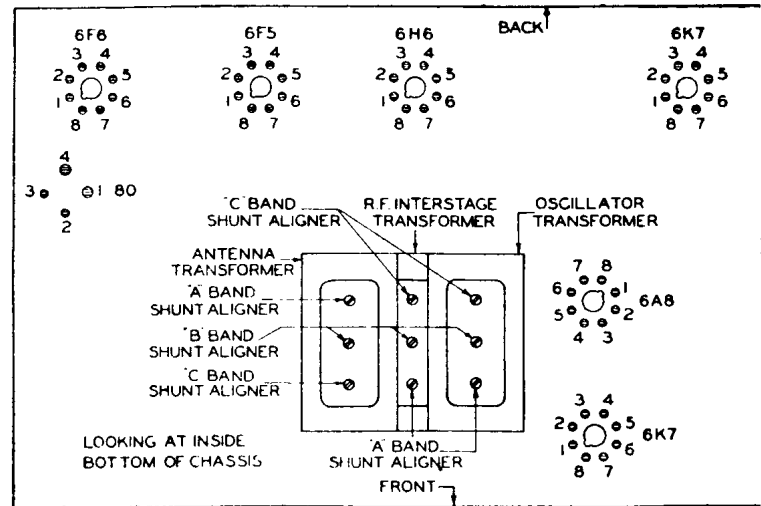

SET TUNED TO 1000 K.C. NO SIGNAL.

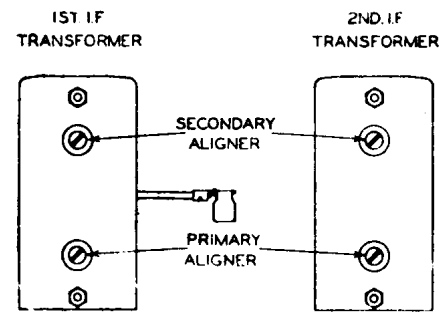
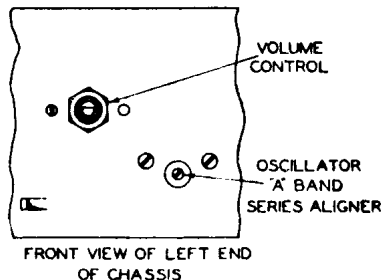

Terminal Layout for Voltage Measurement Chart and Location of Various Aligning Capacitors.

COURTESY - STROMBERG-CARLSON-15 MFG. CO. LTD.
 DATA SHEET
 PRINTED IN CANADA

I.F.=
465
K.C.

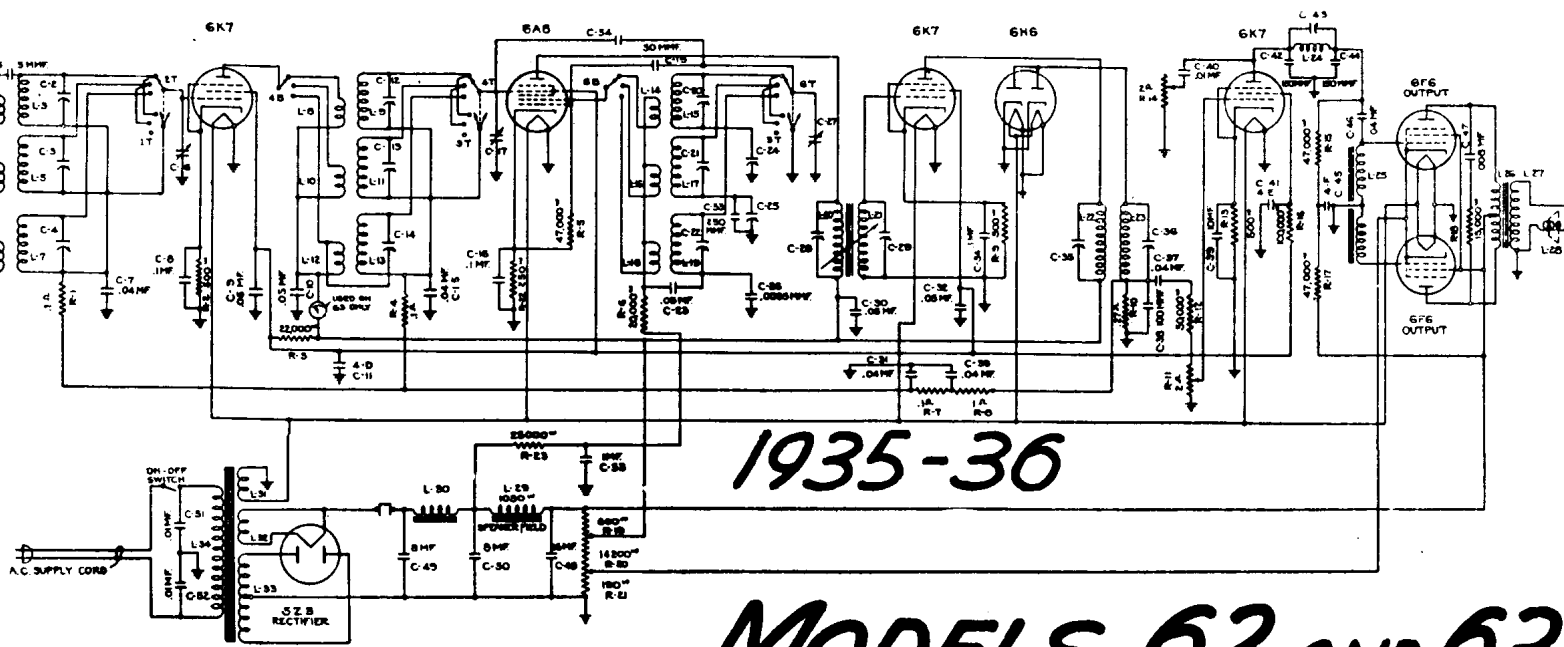

1935-36

MODELS 62 AND 63

ALIGNMENT INSTRUCTIONS & TRIMMER LAYOUT ON DATA SHEETS 21 and 22.

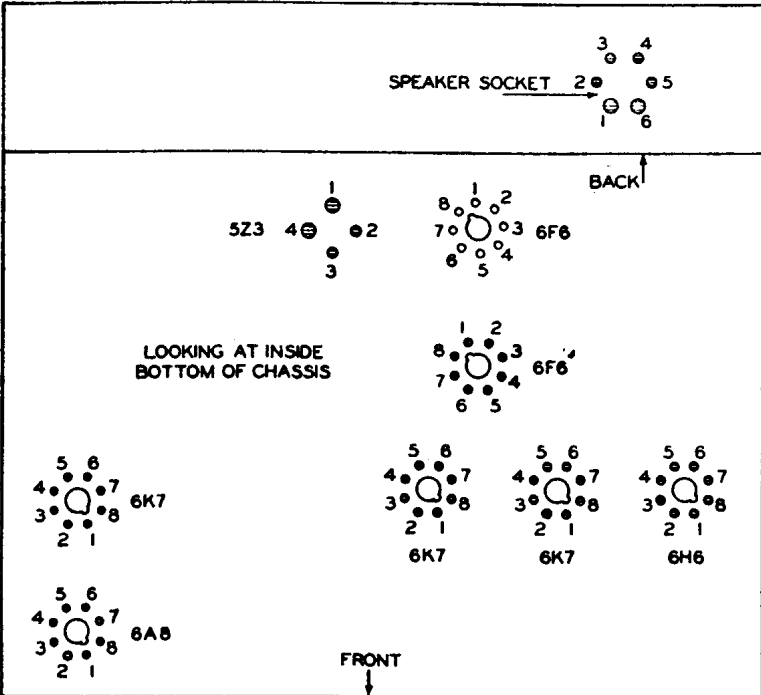

Terminal Sockets

	1	2	3	4	5	6	7	8
6K7 R.F. AMP.	0	—	+230	+ 95	+ 3	—	—	+ 3
6A8 MOD. OSC.	0	—	+235	+ 95	0	+150	—	+ 3
6K7 I.F. AMP.	0	—	+230	+ 95	+ 3.5	—	—	+ 3.5
6H6 DEM. A.V.C.	0	—	0	0	0	—	—	—
6K7 A.F. AMP.	0	—	+ 25	+ 35	+1.5	—	—	+ 1.5
6F6 OUT. PUT.	0	0	+250	+260	0	—	0	+16
5Z3 RECT.	+428	405	405	+428				
	+260	+400	+430	+430	+260	+260		

SET TUNED TO 1000 K.C. NO SIGNAL.

COURTESY- STROMBERG-CARLSON-16 MFG. CO. LTD.
 DATA SHEET
 PRINTED IN CANADA

MODELS 65-66-67

TRIMMER LOCATIONS ON DATA
SHEET 22

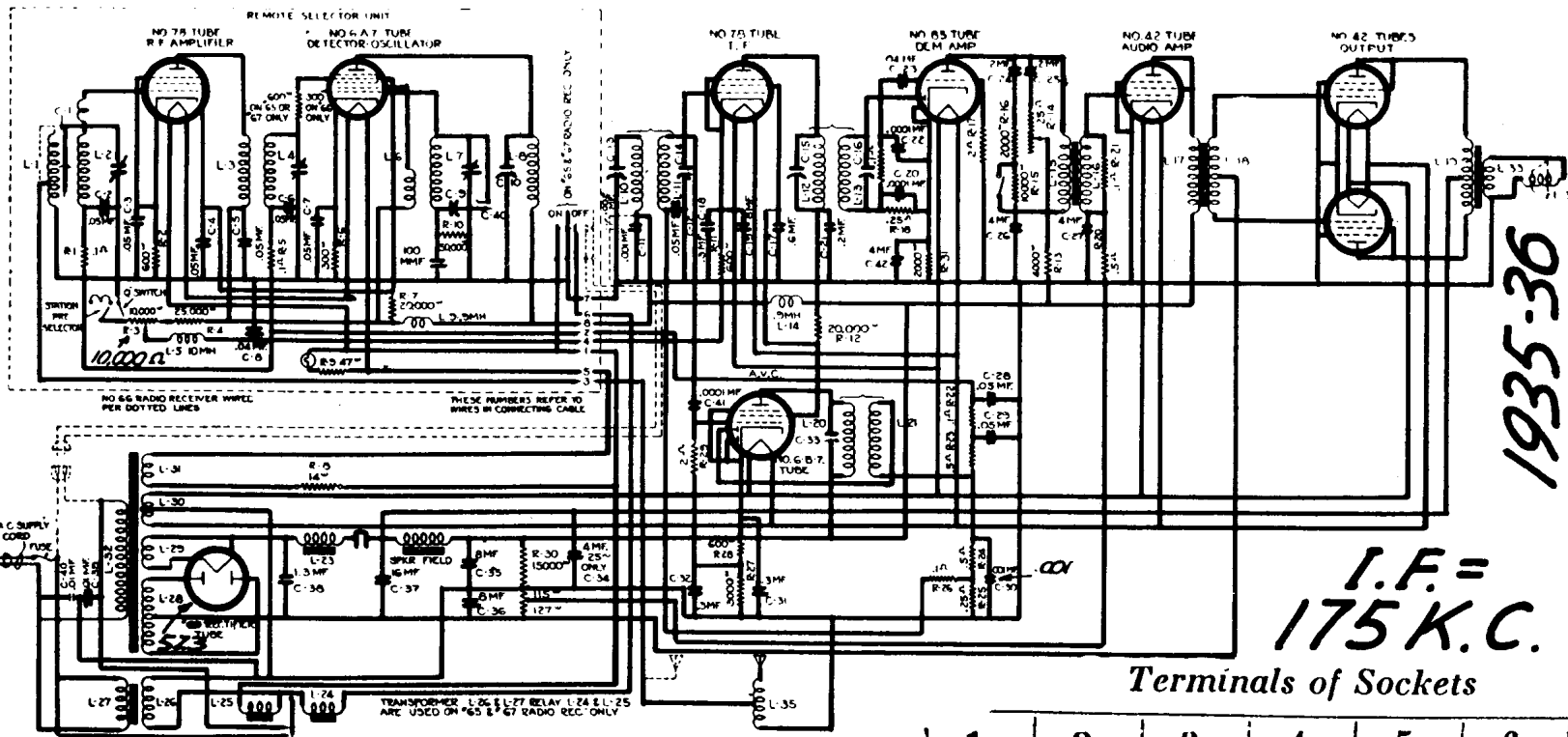

1935-36

Terminals of Sockets

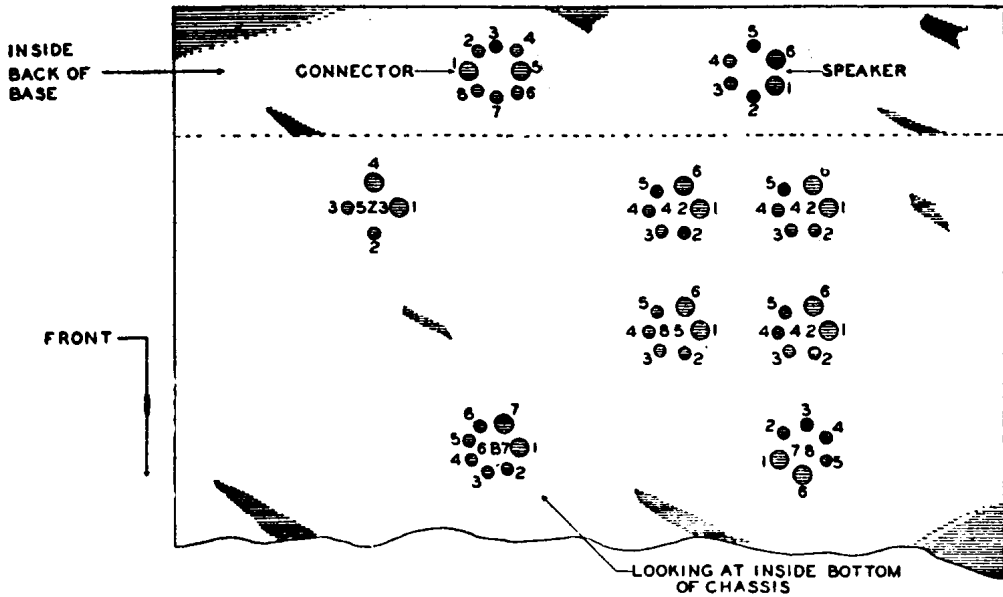

	1	2	3	4	5	6
78 R.F. AMP.		+200	+100	+ 3	+ 3	
6A7 M.I.E.R. OSC.		+200	+100	+200	- 11	+ 3
78 I.F.		+180	+ 75	+ 2	+ 2	
6B7 I.F. DEM.		+180	+ 75	0	+ 12	+ 12
85 1ST. AUDIO		+180	0	+ 13	+ 13	
42 2ND. AUDIO		+170	+170	- 16	0	
42's OUT. PUTS		+345	+345	- 32	0	
A. C. voltage between plate terminals and chassis						
5Z3 RECT.		500	500			
Speaker Socket	0	+193	+350	+350	+350	0

COURTESY - STROMBERG-CARLSON-17
 DATA SHEET
 MFG. CO. LTD.
 PRINTED IN CANADA

MODEL 82

I.F. = 465 K.C.

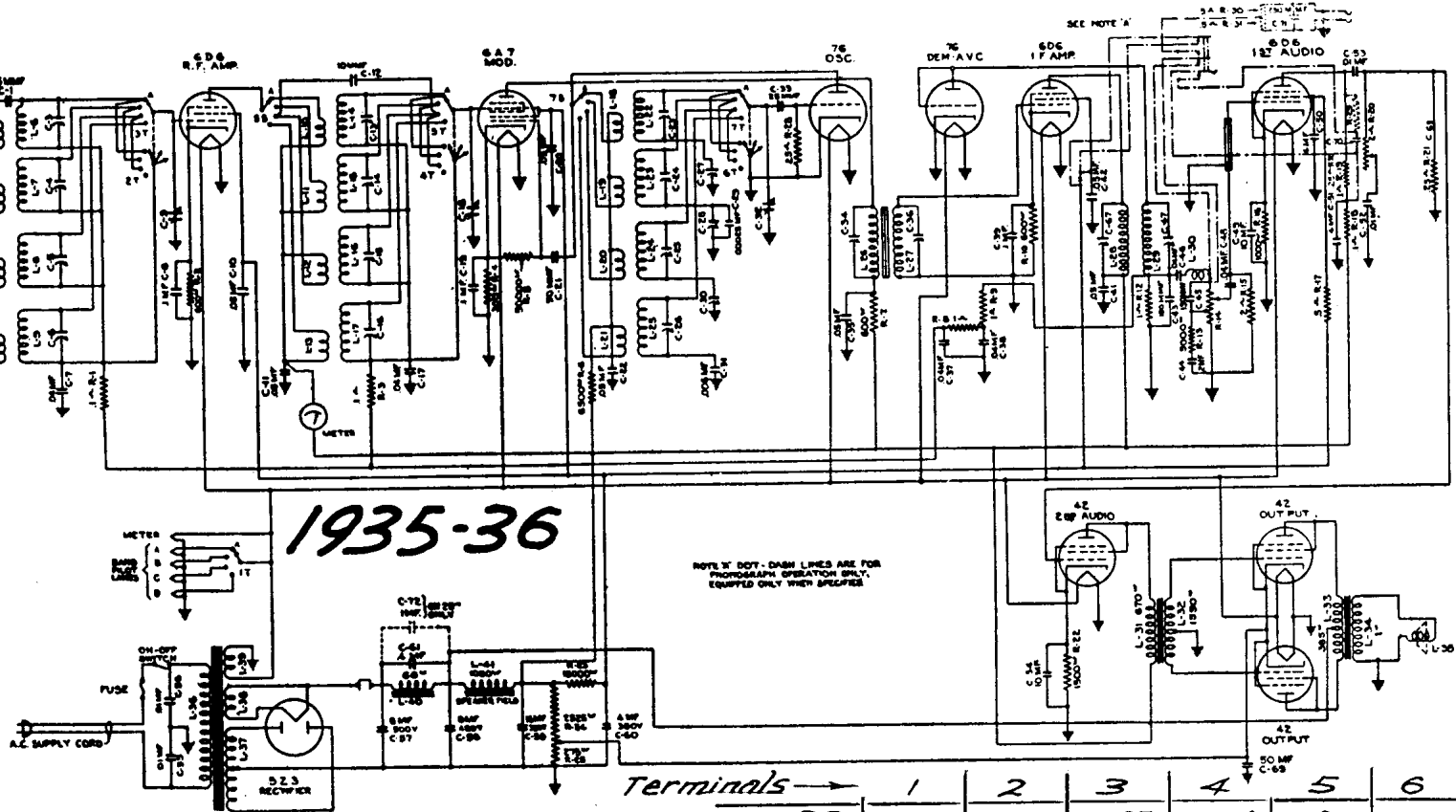

1935-36

NOTE: DASH-DOT LINES ARE FOR PHOTODUPLICATION ONLY, EQUIPPED ONLY WHEN SPECIFIED

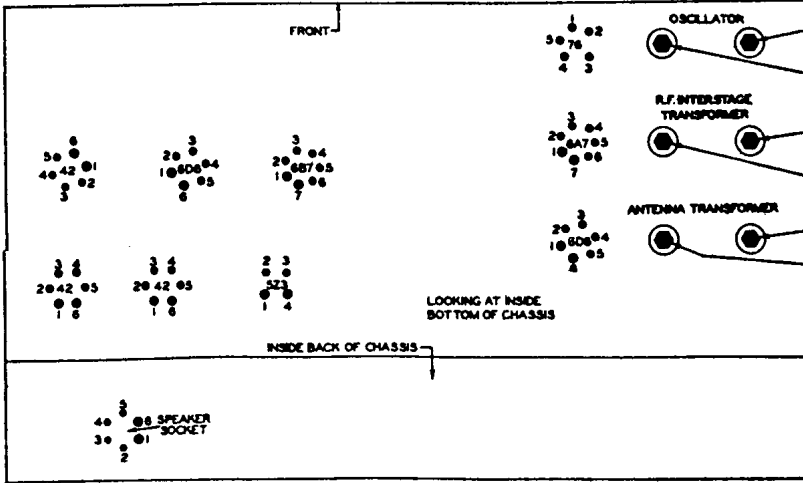

ALIGNMENT INSTRUCTIONS ON DATA SHEETS 21 & 22.

Terminals	1	2	3	4	5	6
6D6 R.F. AMP.		+240	+95	+4	0	
6A7 MOD.		+240	+95	+95	-2	+3.1
76 OSC.		+195	+30	0		
6D6 I.F. AMP.		+240	+95	+3.5	+3.5	
76 DEM. A.V.C.		0	0	0		
6D6 1ST. AUDIO		+68	+20	+1	+1	
42 2ND. AUDIO		+230	+230	0	+21	
42 OUTPUT.		+390	+390	0	+37	
5Z3 RECT.	+410	398	398	+410		
Speaker Socket	0	+245	+400	+400	+390	0

COURTESY - STROMBERG-CARLSON-18
 MFG. CO. LTD.
 PRINTED IN CANADA
 DATA SHEET

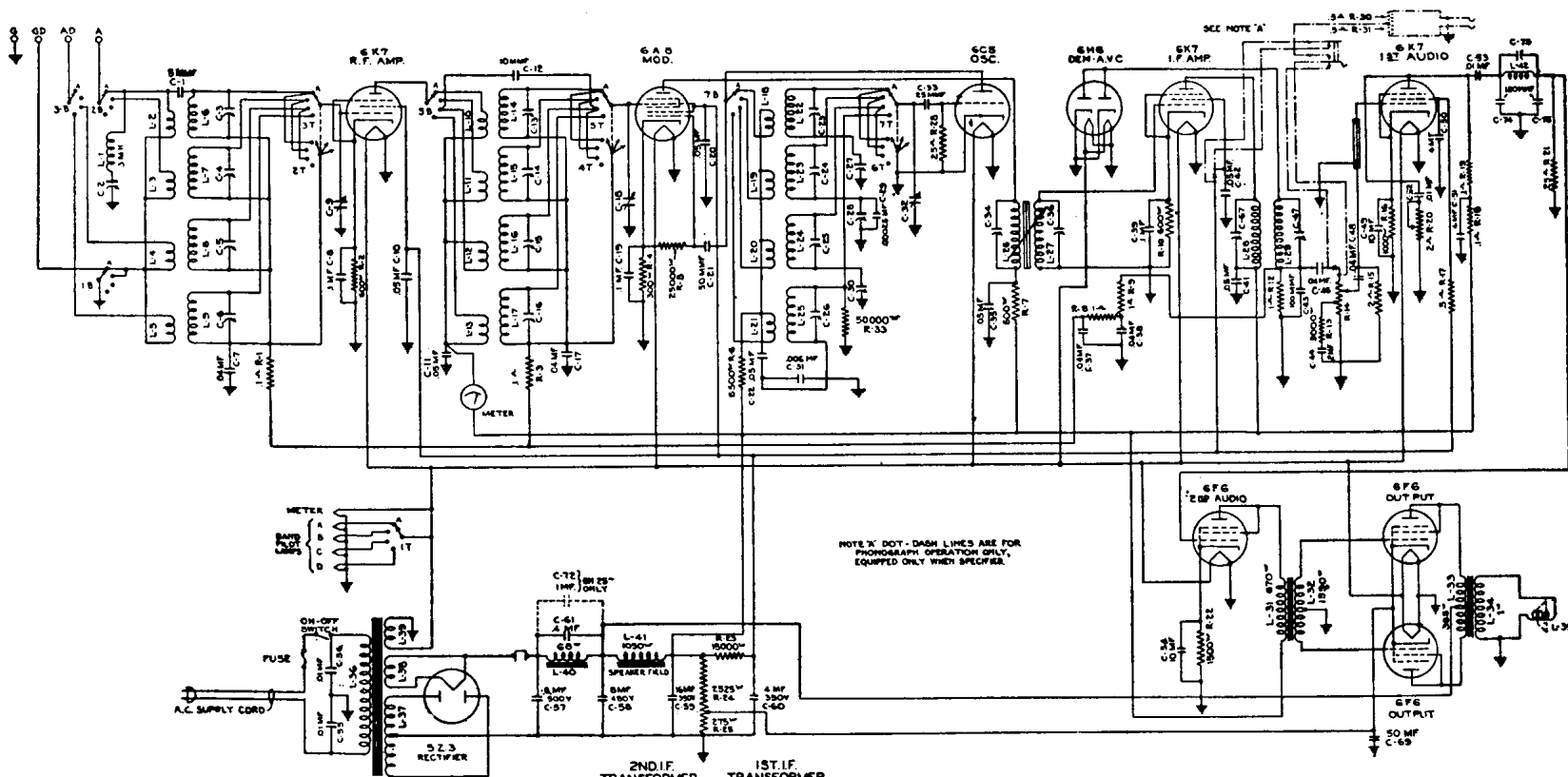

1935-36

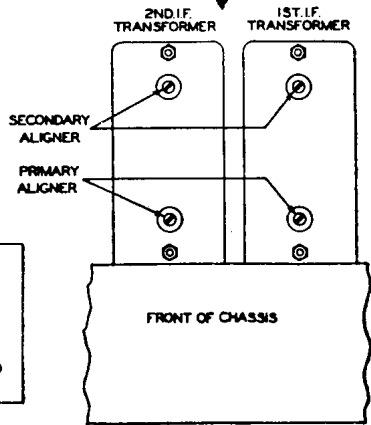
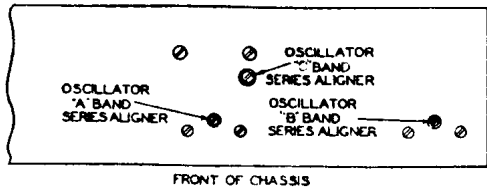

I.F. = 465 K.C.
MODEL 83

ALIGNMENT INSTRUCTIONS, ETC.
 ON DATA SHEETS. 21822.

DATA SHEET **STROMBERG-CARLSON-19** MFG. CO. LTD.
 PRINTED IN CANADA

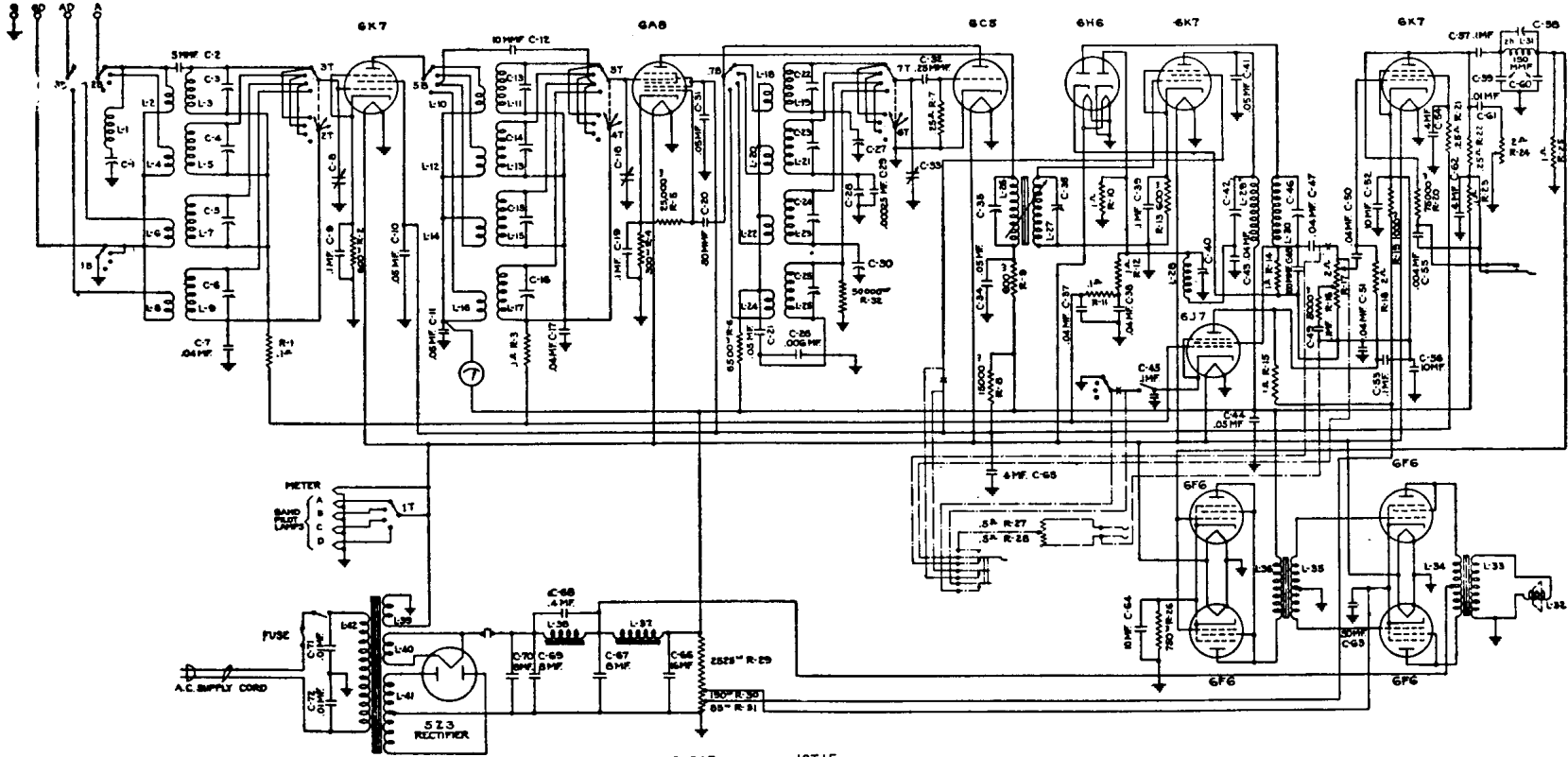

1935-36

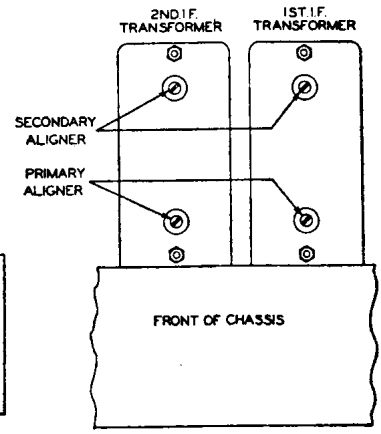
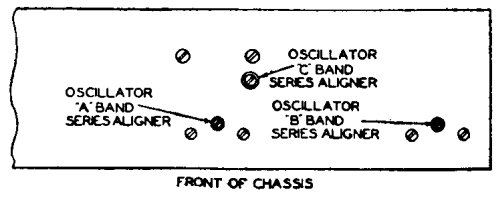

I.F. = 465 K.C.
MODEL 84
 ALIGNMENT INSTRUCTIONS,
 VOLTAGES, ETC. ON DATA SHEETS. 21-22

COURTESY-
STROMBERG-CARLSON-20
 MFG. CO. LTD.
 PRINTED IN CANADA
DATA SHEET

ALIGNMENT INSTRUCTIONS

MODELS 58-61-62-63 82-83-84

For aligning the R.F. and I.F. circuits, it will be necessary to have two artificial antennas, one for the standard broadcast band only, the other for the short-wave bands. A 250 mfd. capacitor in series with the high-side terminal of the signal generator will be satisfactory for use on the standard broadcast band, ("A" Band). A suitable antenna for the short-wave bands may consist of a non-inductive 400 ohm carbon resistor. Better alignment can be obtained if a low-loss shielded cable is used to connect the high and low output terminals of the signal generator to the receiver antenna and ground posts.

ALIGNING I.F. CIRCUITS: There are four adjustments (at 465 K.C.) for the I.F. alignment. Always align either R.F. or I.F. circuits (on receivers equipped with high fidelity circuits) with the high fidelity control at maximum counter-clockwise position (normal fidelity), unless the alignment is being checked at the high fidelity setting which requires cathode ray equipment.

In series with the "A" post of the signal generator connect a capacitor of 0.001 mfd. capacity, which will prevent the voltages (of the amplifier stage being aligned) from becoming upset. From the other terminal of this capacity connect a wire to the control grid of the No. 6K7, I.F. tube, (6D6 in model 58) and from "G" terminal of generator connect a wire to chassis base.

Adjust aligning capacitors which are connected across the secondary and primary coils of second I.F. transformer in the order given until maximum output is obtained.

Now remove wire lead (which connects from the .001 fixed capacitor and the No. 6K7, I.F. tube's grid) from the grid of the No. 6K7, I.F. tube (6D6 in model 58) and connect this wire lead to the control grid cap of the No. 6A8 Modulator tube (6A7 in model 58). Now adjust the aligning capacitors connected across the primary and secondary coils of the first I.F. transformer assembly; adjusting the secondary aligning capacitor first, and the primary aligning capacitor secondly.

ALIGNING R.F. CIRCUITS: On receiver chassis equipped with a "Q" circuit, make sure that "Q" switch is "off". Also on receivers equipped with a high fidelity control, set control for normal fidelity (maximum counter-clockwise rotation). Set tone control at normal position and volume control for maximum volume.

Set modulator switch of signal generator to "on" position. Connect insulated wire inside of shielded lead from high-side terminal of generator unit. Connect metal shield to low-side terminal of generator. The other end of wire inside shielded lead is connected to the particular artificial antenna being used, the other end of shield being connected to chassis base.

CAUTION: As each circuit is aligned in the attenuator on the signal generator must be adjusted. Also, in making these R.F. adjustments, always adjust aligning capacitor of circuit being aligned to maximum capacity and then slowly adjust capacitor in direction of minimum capacity. On some of the alignments, especially in oscillator circuits, it will be noted that there are two positions of aligning capacitor where the signal is obtained. Always leave aligning capacitor set at the minimum capacity setting where the signal is obtained.

Proceed in the following manner, except with Nos. 58 and 61 receivers where "C" band is aligned first.

"A" BAND ALIGNMENT: Set receiver and generator to high frequency setting called for in the table, for this band, of receiver. Adjust shunt aligning capacitors of oscillator, R.F. Amplifier, and Antenna Transformers. Set receiver and signal generator to low frequency setting called for in table, and align only the oscillator by means of oscillator series aligning capacitor. Again check adjustments of shunt aligning capacitors of Oscillator, R.F. Amplifier, and Antenna Transformers.

"B" BAND ALIGNMENT: Align Oscillator, R.F. Amplifier and Antenna Transformers in the same manner as for "A" band, using frequencies listed in table under "B" band.

"C" BAND ALIGNMENT: Proceed in same manner as for "A" and "B" bands.

"D" BAND ALIGNMENT: Proceed in the same manner as given for the "A", "B", and "C" bands.

ALIGNMENT FREQUENCIES.—

Nos. 58 and 61 Receivers

Band	High Frequency Aligning Point	Frequency for Aligning Oscillator Series Aligning Capacitor
"A"	1400 Kilocycles	600 Kilocycles
"B"	3000 Kilocycles	No Aligner
"C"	16 Megacycles	No Aligner

Nos. 62 and 63 Receivers

Band	High Frequency Aligning Point	Frequency for Aligning Oscillator Series Aligning Capacitor
"A"	1500 Kilocycles	600 Kilocycles
"B"	5000 Kilocycles	1800 Kilocycles
"C"	16 Megacycles	No Aligner

Nos. 82, 83, and 84 Receivers

Band	High Frequency Aligning Point	Frequency for Aligning Oscillator Series Aligning Capacitor
"A"	1500 Kilocycles	600 Kilocycles
"B"	4000 Kilocycles	1500 Kilocycles
"C"	10 Megacycles	4 Megacycles
"D"	19.8 Megacycles	No Aligner

ALIGNMENT INSTRUCTIONS

TRIMMER LOCATIONS, ETC. FOR STROMBERG-CARLSON MODELS AS SHOWN BELOW.

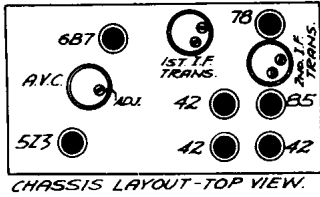
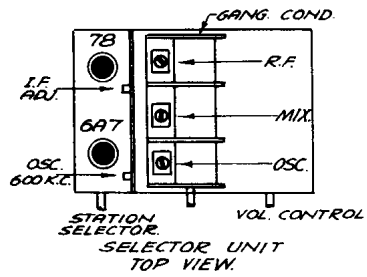

CHASSIS LAYOUT, AND TRIMMER LOCATIONS FOR MODELS 65-66-67

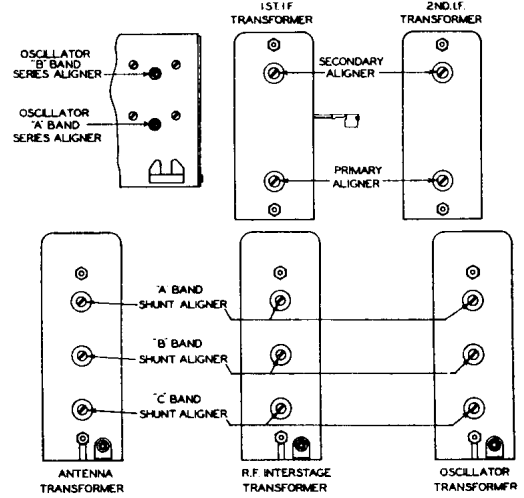

RIGHT - TRIMMER LOCATIONS FOR MODELS 62-63

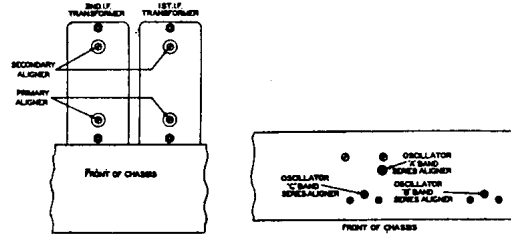

ABOVE - TRIMMER LOCATIONS FOR MODEL 62

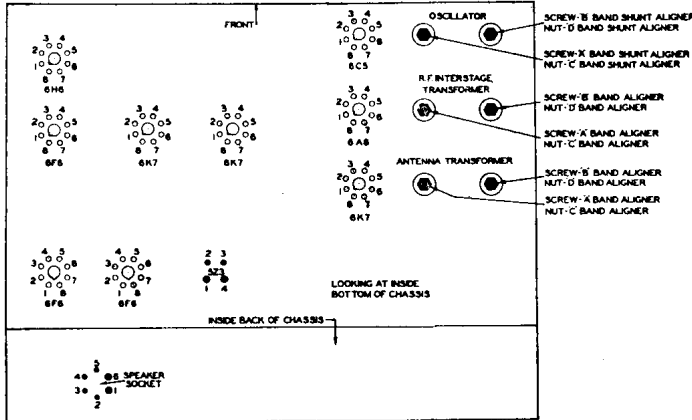

	1	2	3	4	5	6	7	8
6K7 R.F. AMP.	0	—	+250	+ 70	+ 3	0	—	+ 3
6A8 MOD.	0	—	+250	+ 70	—	+ 70	—	+ 2.5
6C5 OSC.	0	—	+210	0	—	—	—	—
6K7 I.F. AMP.	0	—	+250	+ 70	+ 3	—	—	+ 3
6H6 DEM. A.V.C.	0	—	—	—	—	—	—	—
6K7 1ST. AUDIO	0	—	+100	+ 35	+ 1	—	—	+ 1
6F6 2ND. AUDIO	0	—	+240	+240	0	—	—	+20
6F6 OUT. PUT.	0	—	+390	+390	0	—	—	+35
5Z3 RECT.	+410	395	395	+410				
Speaker Socket	0	+250	+410	+410	+395	0		

ABOVE - SOCKET LAYOUT, TRIMMER LOCATIONS AND TUBE VOLTAGES, FOR MODEL 63.

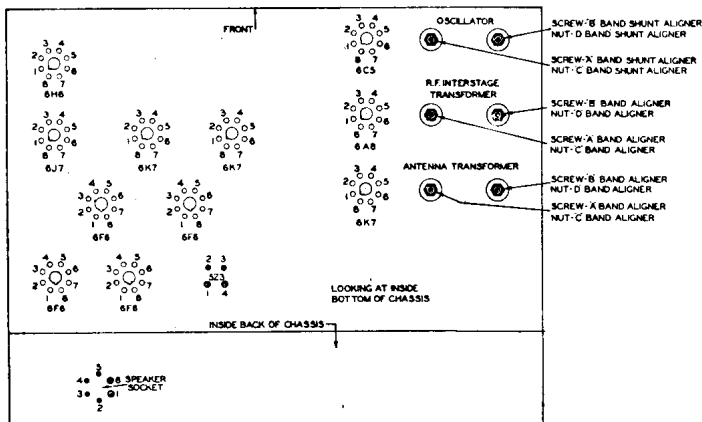

Tube	Terminals of Sockets							
	1	2	3	4	5	6	7	8
6K7 R.F. AMP.	0	—	+240	+ 90	+ 3.5	0	—	+ 3.5
6A8 MOD.	0	—	+240	+ 85	—	+ 85	—	+ 2
6C5 OSC.	0	—	+195	—	—	—	—	—
6K7 I.F. AMP.	0	—	+230	+ 85	+ 3.5	—	—	+ 3.5
6H6 DEM. A.V.C.	0	—	—	—	—	—	—	—
6K7 1ST. AUDIO	0	—	+100	+ 35	+ 10	—	—	+10
6J7 'Q'	0	—	—	—	—	—	—	—
6F6 2ND. AUDIO	0	—	+220	+220	0	—	—	+20
6F6 OUT. PUT.	0	—	+390	+390	0	—	—	+30
5Z3 RECT.	+410	395	395	+410				
Speaker Socket	0	+250	+410	+410	+395	0		

ABOVE - SOCKET LAYOUT, TRIMMER LOCATIONS AND TUBE VOLTAGES FOR MODEL 64